

SIEMENS



SINAMICS Drives

Medium Voltage Converters

SINAMICS GM150
SINAMICS SM150

Catalog
D 12

Version 5.2
05/2023

[siemens.com/sinamics-gm150](https://www.siemens.com/sinamics-gm150)

[siemens.com/sinamics-sm150](https://www.siemens.com/sinamics-sm150)

SIEMENS

SINAMICS GM150 SINAMICS SM150

Medium voltage drives

Catalog D 12

05-23-2023 – Version 5.2

Introduction	1
SINAMICS GM150 IGBT version	2
SINAMICS GM150 IGCT version	3
SINAMICS SM150 IGBT version	4
SINAMICS SM150 in IGCT version	5
SINAMICS SM150 IGCT version with diode infeed	6
Options	7
Static excitation units	8
Accessories	9
Motors for converter operation	10
Engineering information	11
SIDRIVE IQ	12
Services and documentation	13



The products and systems described in this catalog are manufactured/distributed under application of a certified quality management system in accordance with EN ISO 9001 (Certified Registration No. 002241 QM UM). The certificate is recognized by all IQNet countries.

Table of contents

1	Introduction	9
1.1	Overview of catalog changes	9
1.2	Overview of SINAMICS medium voltage drives	10
1.3	SINAMICS GM150 and SINAMICS SM150.....	11
1.4	Benefits	13
2	SINAMICS GM150 IGBT version	14
2.1	Overview	14
2.2	Benefits	15
2.3	Design.....	15
2.4	Function	19
2.5	Selection and ordering data.....	23
2.5.1	Air cooling	23
2.5.2	Water cooling.....	24
2.6	Technical specifications.....	26
2.6.1	General technical data.....	26
2.6.2	Derating for special installation conditions	29
2.6.3	Type-specific technical data	32
3	SINAMICS GM150 in the IGCT version.....	49
3.1	Overview	49
3.2	Benefits	50
3.3	Design.....	50
3.4	Function	54
3.5	Engineering.....	58
3.6	Selection and ordering data.....	59
3.7	Technical specifications.....	60
3.7.1	General technical data.....	60
3.7.2	Derating for special installation conditions	63
3.7.3	Type-specific technical data	64

4	SINAMICS SM150 in the IGBT version	66
4.1	Overview	66
4.2	Benefits	67
4.3	Design.....	67
4.4	Function	70
4.5	Selection and ordering data.....	73
4.6	Technical specifications.....	74
4.6.1	General technical data.....	74
4.6.2	Derating for special installation conditions	77
4.6.3	Type-specific technical data	79
5	SINAMICS SM150 in the IGCT version	82
5.1	Overview	82
5.2	Benefits	83
5.3	Design.....	83
5.4	Function	88
5.5	Selection and ordering data.....	91
5.6	Technical specifications.....	92
5.6.1	General technical data.....	92
5.6.2	Derating for special installation conditions	95
5.6.3	Type-specific technical data	96
6	SINAMICS SM150 in the IGCT version with diode infeed	100
6.1	Overview	100
6.2	Design.....	100
6.3	Selection and ordering data.....	102
7	Options.....	103
7.1	Overview	103
7.2	Description of the options	110

8	Static excitation units	163
8.1	Static excitation unit versions	163
8.2	Use with medium voltage converters.....	164
8.3	General technical data.....	165
8.3.1	Environmental conditions.....	165
8.3.2	Derating	165
8.4	SINAMICS DCM for slip-ring excitation	166
8.4.1	Selection and ordering data.....	166
8.4.2	Accessories	166
8.4.3	Technical specifications.....	167
9	Accessories	169
9.1	Accessories for grounding and short-circuiting	169
9.1.1	Overview	169
9.1.2	Selection and ordering data.....	169
9.2	Accessories for replacing phase modules	170
9.2.1	Replacing the complete phase module (SINAMICS GM150 in the IGCT version and SINAMICS SM150 in the IGCT version).....	170
9.2.2	Replacing individual IGCT modules (SINAMICS SM150 in the IGCT version).....	170
9.3	Commissioning tools.....	171
10	Motors for converter operation	171
11	Engineering information.....	172
11.1	Current product information.....	172
11.2	Drives Technology Configurator selection tool.....	172
11.3	Overview of interfaces	173
11.3.1	Overview of connections for SINAMICS GM150.....	173
11.3.2	Overview of connections for SINAMICS SM150	174
11.4	Cooling unit.....	175
11.4.1	Overview	175
11.4.2	Mode of operation.....	175
11.4.3	Function	175
11.4.4	Technical specifications.....	178
11.5	Circuit breakers.....	179
11.6	Transformers	180
11.7	Power cables	183
11.8	System integration	186

11.9	Motors	187
11.10	Scope of delivery	191
12	SIDRIVE IQ	193
13	Services and documentation	194
13.1	Services for Large Drives Applications	194
13.2	Training Center	196
13.3	Documentation.....	197

1 Introduction

1.1 Overview of catalog changes

This catalog will be updated on an irregular basis. See the following table for an overview of important changes compared to the previous version.

Table 1-1 Overview of catalog changes

Version	Section	Description	Rev.	Sup.	
5.2	Some	Minor corrections	X		
	2.6.3	Data for raw water flow rate updated	X		
	7		Option D09 (new): 3D model in the STEP format		X
			Option L72: Information on the deionized water requirement for Braking Modules	X	X
			Option U01 (new): UL listing		X
			Option W90 (new): Converter without phase modules		X
			Option Y35 (new): Customer-specific cabinet labeling		X

Rev. = Revision, Sup. = Supplement

1.2 Overview of SINAMICS medium voltage drives

	SINAMICS PERFECT HARMONY GH150	SINAMICS PERFECT HARMONY GH180	SINAMICS GM150 (IGBT/IGCT)
Power range	Direct water cooling: 4.0 to 47 MVA Air cooling and indirect water cooling: 4.0 to 70 MVA ¹⁾	Up to 24.4 MVA	1.0 to 24 MVA
Area of application	General purpose applications	General purpose applications	General purpose applications
Motors	Induction and synchronous motors	Induction and synchronous motors	Induction and synchronous motors
Energy recovery	No	No	No
Multi-motor drives	No	No	No
Semiconductors	LV-IGBT	LV-IGBT	HV-IGBT/IGCT
Topology	Voltage source inverters: Cell-based topology, modular multilevel converters	Voltage source inverters: Cell-based topology, multilevel cascaded H-bridge cells	Voltage source inverters: Three-level neutral point clamped topology (NPC)
Typical applications	Pumps, fans, compressors, existing line motors, ESP, blast furnace blowers, propulsion, boiler feed pumps, test stands, LNG starter/helper (all-electric)	Pumps, fans, compressors, uphill conveyors, existing line motors, extruders, kneaders, mixers, crushers, agitators, presses, ESP, kilns, high-pressure grinders, vertical/horizontal mills, blast furnace blowers, boiler feed pumps, test stands, LNG starter/helper (all-electric)	Pumps, fans, compressors, uphill conveyors, extruders, kneaders, mixers, crushers, excavators, high-pressure grinders, vertical/horizontal mills, blast furnace blowers, propulsion, thrusters, boiler feed pumps, agitators, presses, wire rod mills

1) 70 MVA power for dual circuit, on request (single circuit: up to 35 MVA)

	SINAMICS SM150 (IGBT/IGCT)	SINAMICS SH150	SINAMICS GL150	SINAMICS SL150
Power range	3.4 to 31.5 MVA	4.0 to 16 MVA	2.8 to 85 MVA	3.0 to 40 MVA
Area of application	Sophisticated applications	Sophisticated applications	General purpose applications	Sophisticated applications
Motors	Induction and synchronous motors	Induction and synchronous ²⁾ motors	Synchronous motors	Induction and synchronous ²⁾ motors
Energy recovery	Yes	Yes	Yes	Yes
Multi-motor drives	Yes	No	No	No
Semiconductors	HV-IGBT/IGCT	LV-IGBT	Thyristor	Thyristor
Topology	Voltage source inverters: Three-level neutral point clamped topology (NPC)	Voltage source inverters: Cell-based topology, modular multilevel converters	Current source inverters: Load commutated inverters (LCI)	Cyclo converters: Open star point and common star point topology
Typical applications	Downhill conveyors, horizontal mills, rolling mills, mine winders, test stands	Pumps, fans, compressors, existing line motors, shaft generators/boosters, hydro-electric generators, onshore power supply, test stands	Pumps, fans, compressors, extruders, pump storage, boiler feed pumps, starting generators, blast furnace blowers, starting blast furnace blowers, propulsion, test stands, shaft generators/boosters, LNG starter/helper (all-electric)	Uphill/downhill conveyors, rolling mills, horizontal mills, excavators, mine winders, ore crushers and cement mills

2) On request

1.3 SINAMICS GM150 and SINAMICS SM150

SINAMICS GM150 and SINAMICS SM150 converters represent the expansion of the SINAMICS drive family in the medium voltage range. They are supplied as ready-to-connect cabinet units.

SINAMICS GM150



Fig. 1-1 SINAMICS GM150

SINAMICS GM150 converters are designed as individual drive for applications with square-law and constant load characteristics without regenerative feedback.

Typical applications:

- Pumps and fans
- Compressors
- Extruders and mixers
- Mills
- Marine drives

The inverters on the motor side (Motor Modules) have IGBT power semiconductors in the lower power range to 13 MVA, and IGCT power semiconductors in the upper power range from 10 MVA to 21 MVA.

SINAMICS SM150

Fig. 1-2 SINAMICS SM150

SINAMICS SM150 converters are designed for demanding single and multi-motor applications and meet the following requirements:

- High dynamic response
- Operation at low frequency
- Line power factor = 1.0 (can be freely selected)
- Four-quadrant operation

Typical applications:

- Roller drives (cold, hot)
- Hoisting drives
- Test stands
- Belt systems

Both the line-side infeed/regenerative feedback units (Active Line Modules) and the motor-side inverters are either equipped with IGBT or IGCT power semiconductors.

	SINAMICS GM150 IGBT	SINAMICS GM150 IGCT	SINAMICS SM150 IGBT	SINAMICS SM150 IGCT	
Line Module (line-side rectifier)					
Basic Line Module, 12-pulse (two-quadrant operation)	Standard	Standard	–	–	
Basic Line Module, 24-pulse (two-quadrant operation)	Option Standard for parallel circuit configuration	Option Standard for parallel circuit configuration	–	–	
Basic Line Module, 36-pulse (two-quadrant operation)	–	Standard for triple parallel circuit configuration	–	–	
Active Line Module (four-quadrant operation)	–	–	Standard	Standard	
Motor Module (motor-side inverter)					
Voltage range	2.3 ... 4.16 kV	3.3 kV	3.3 and 4.16 kV	3.3 kV	
Power range (typ.)	1 ... 13 MVA	10 ... 21 MVA	3.4 ... 7.2 MVA	5 ... 31.5 MVA	
Cooling method • Air cooling • Water cooling	Standard Standard	– Standard	Standard Standard	– Standard	
Control modes • Induction motor • Synchronous motor, separately excited with slipring excitation • Synchronous motor, separately excited with brushless reverse field excitation • Synchronous motor, permanently excited	<u>Without encoder</u> Standard On request On request On request	<u>With encoder</u> Standard Option On request On request	<u>Without encoder</u> Standard On request On request On request	<u>With encoder</u> Standard Option On request Option	<u>With encoder is standard</u> Standard Option On request Option
Sine-wave filter	On request	–	On request	–	
DC bus configuration with several Motor Modules on one common DC bus	–	–	–	Standard	

1.4 Benefits

- Favorable costs: across the board from planning through to service
- Simple and uncomplicated in every respect: engineering, integration, operation and diagnostics
- High availability: robust and reliable components, easy installation, high service friendliness

2 SINAMICS GM150 IGBT version

2.1 Overview



Fig. 2-1 SINAMICS GM150 in the IGBT version (air-cooled)

SINAMICS GM150 converters in the IGBT version can be optimally combined with Siemens converter motors. This ensures that the drive solution is particularly cost effective, compact and efficient.

SINAMICS GM150 converters in the IGBT version offer cost-effective drive solutions that can be matched to customers' specific requirements by selecting from the wide range of components and options.

IGBT converters are available for the following voltages and outputs:

Rated output voltage	Type rating for air cooling	Type rating for water cooling
2.3 kV	1.0 ... 3.2 MVA	2.0 ... 4.0 MVA
3.3 kV	1.0 ... 8.0 MVA	2.0 ... 10.3 MVA
4.16 kV	1.3 ... 10.1 MVA	2.0 ... 13.0 MVA

Global use

SINAMICS GM150 converters in the IGBT version are manufactured to international standards and regulations, making them ideally suited for global use. These converters are also available in ship-going form (meeting the requirements of all major classification organizations).

2.2 Benefits

- Compact design and highly flexible configuration ensures easy plant integration
- Simple operator control and monitoring from the user-friendly operator panel
- Simple and reliable operation through integrated maintenance functions: The converter signals early on and automatically if maintenance is required or components need to be replaced
- High degree of ruggedness and reliability by using HV IGBT technology and a fuseless design combined with intelligent response to external disturbances
- Can be easily integrated into automation solutions as the PROFINET interface is supplied as standard along with various analog and digital interfaces
- High level of service-friendliness through innovative power section design with plug-in Powercards and easy access to all components
- Multi-motor circuit for operating two motors, especially for applications in the minerals area (on request, also for more than two motors)

2.3 Design

SINAMICS GM150 converters in the IGBT version are available with a 12-pulse or 24-pulse Basic Line Module.

The 12-pulse version is standard for lower output power ratings with voltages of 2.3 kV, 3.3 kV and 4.16 kV.

For higher output power ratings, two 12-pulse Basic Line Modules (this results in a 24-pulse system) and two Motor Modules are connected in parallel with a common DC link.

The 24-pulse Basic Line Module is optionally available for lower power ratings with voltages of 2.3 kV, 3.3 kV and 4.16 kV.

HV IGBT power semiconductors are used in the Motor Modules – they are mounted on plug-in Powercards that are simple to replace.

The converter cabinet unit consists of a section for the Basic Line Module, a section for the Motor Module and the control section.

In the standard version, line and motor cables are connected from the bottom. A connection from the top is optionally possible.

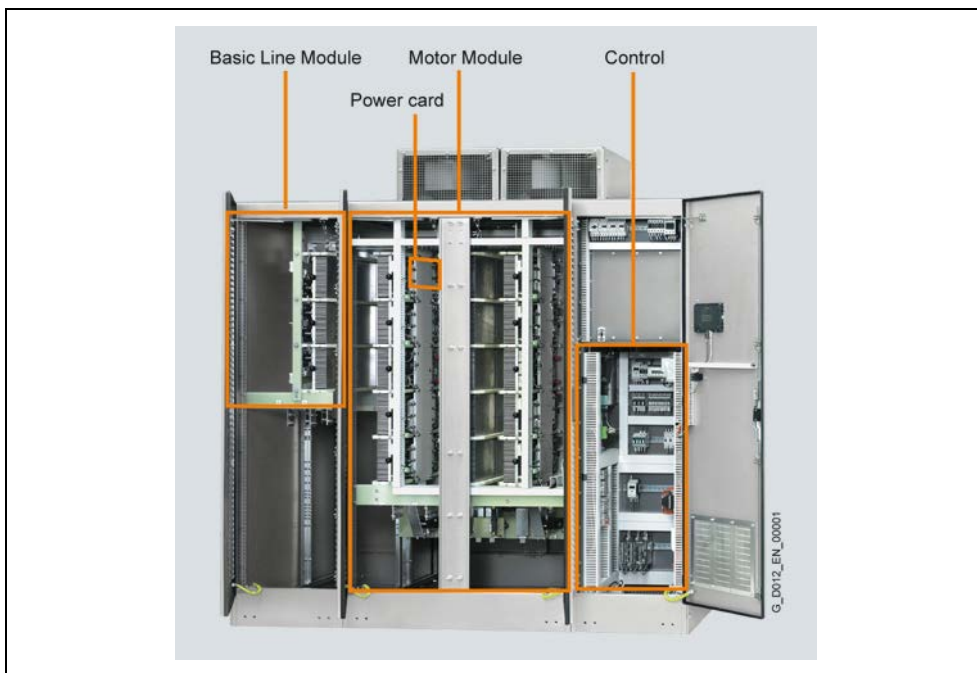

Fig. 2-2 SINAMICS GM150 as air-cooled IGBT version, internal design

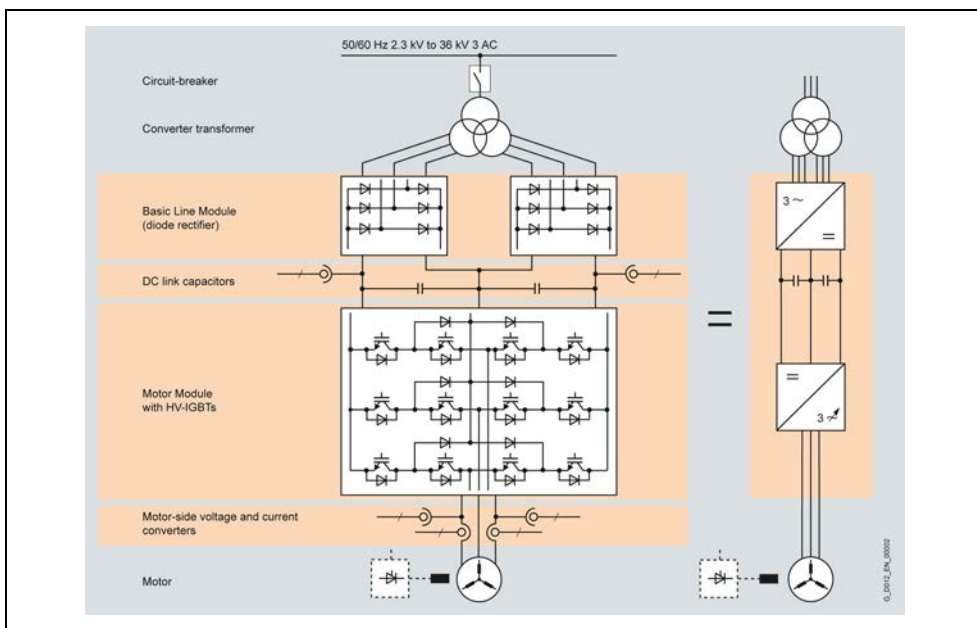

Fig. 2-3 Block diagram

The following circuit versions are available for SINAMICS GM150 in the IGBT version.

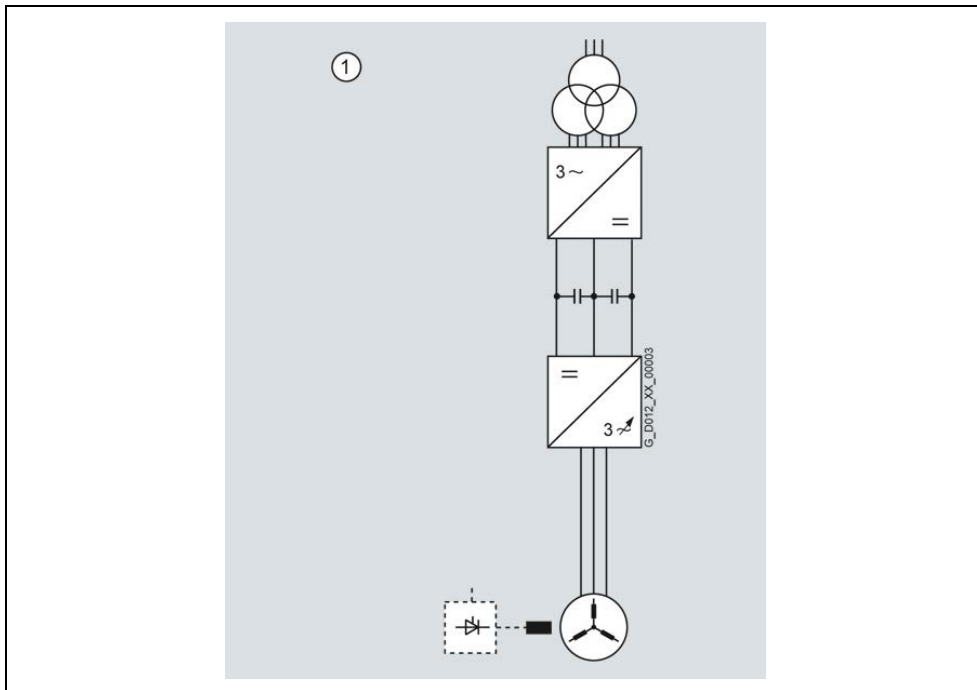

Fig. 2-4 Basic circuit, 12-pulse infeed, diode rectifier in the Basic Line Module connected in series

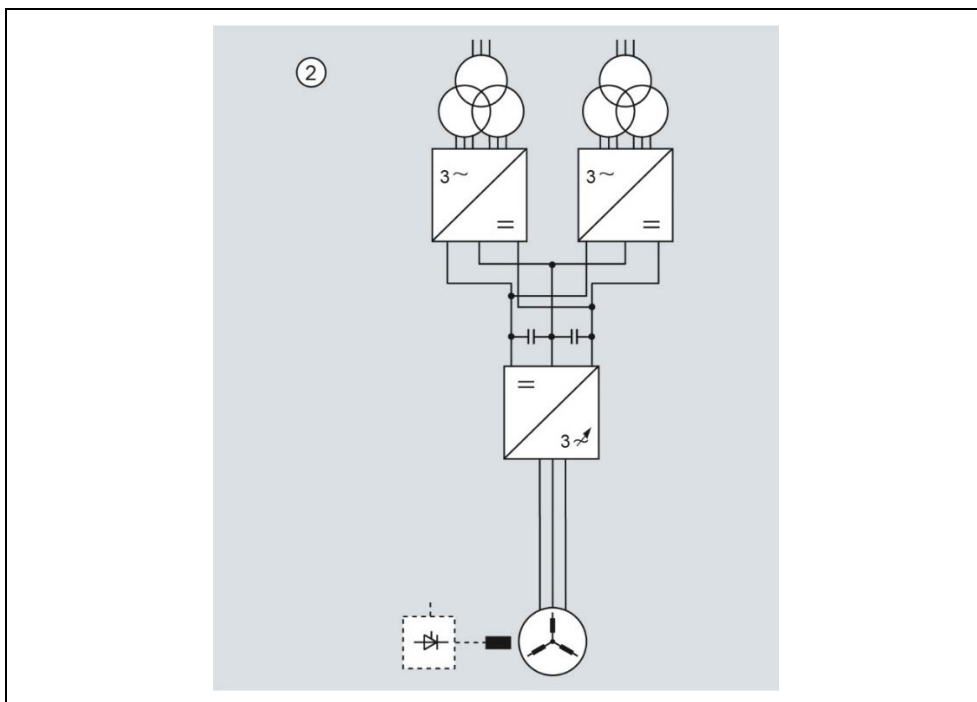

Fig. 2-5 24 pulse infeed by connecting two Basic Line Modules in parallel (option **N15**), diode rectifier connected in parallel in the Basic Line Module

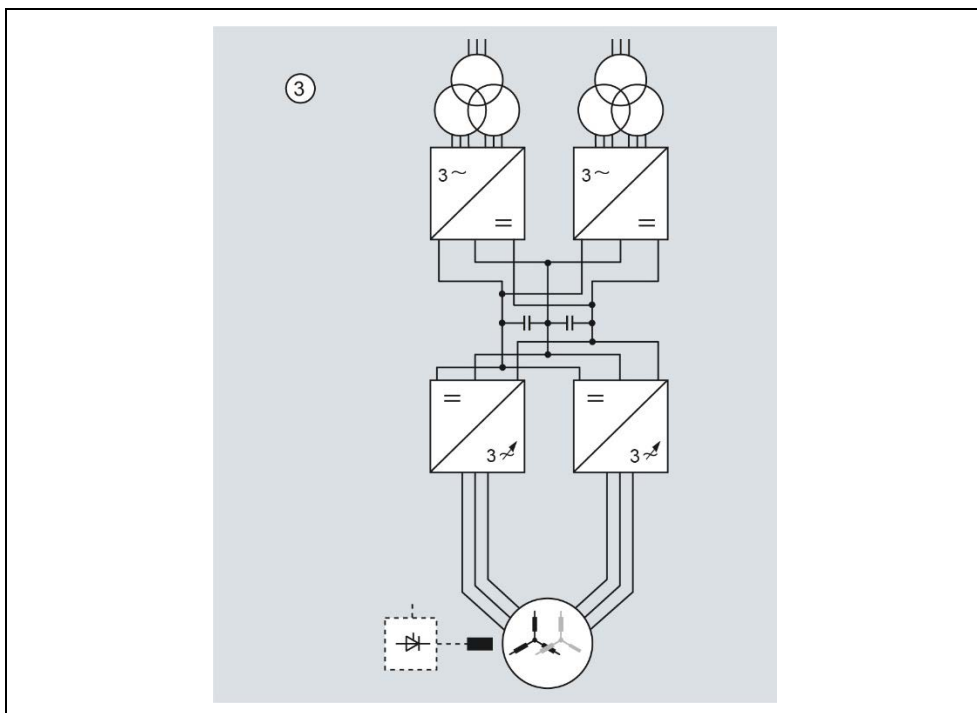

Fig. 2-6 Increased power rating by connecting Basic Line Modules and Motor Modules in parallel on a common DC bus for 3.3 kV and 4.16 kV (24-pulse infeed as standard), diode rectifier connected in parallel in the Basic Line Module

Note:

The motor cables are combined in the motor terminal box.

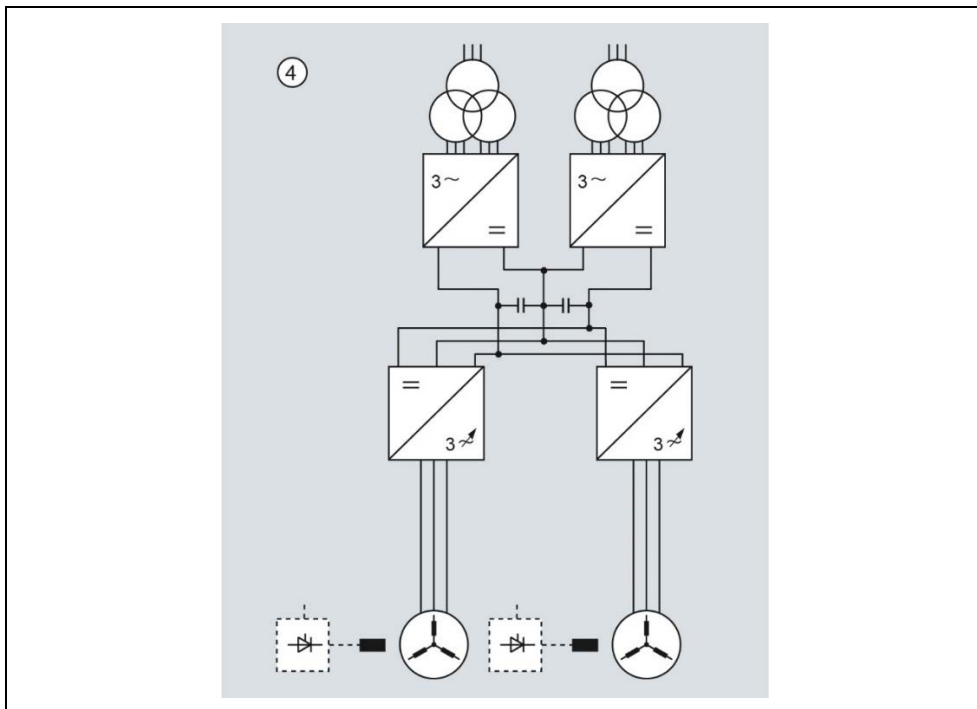

Fig. 2-7 DC bus configuration with two motors connected to a common DC link

2.4 Function

Characteristic features

SINAMICS GM150 in the IGBT version		
Line Module (line-side rectifier)		
Basic Line Module, 12-pulse (two-quadrant operation)	Standard	
Basic Line Module, 24-pulse (two-quadrant operation)	Option for basic circuit 2.3/3.3/4.16 kV Standard for parallel circuit 3.3/4.16 kV	
Motor Module (motor-side inverter)		
Voltage range	2.3 ... 4.16 kV	
Power range (typ.)	1 ... 13 MVA	
Cooling method	<ul style="list-style-type: none"> • Air cooling • Water cooling 	
Control modes	<u>Without encoder</u>	<u>With encoder</u>
	Standard	Standard
	On request	Option
	On request	On request
• Induction motor	On request	On request
• Synchronous motor, separately excited with slipring excitation	On request	On request
• Synchronous motor, separately excited with brushless reverse field excitation	On request	On request
• Synchronous motor, permanently excited	On request	On request
Sine-wave filter	On request	

Software and protection functions

SINAMICS GM150 in the IGBT version	Description
Closed-loop control	<p>The motor-side closed-loop control is realized as a field-oriented closed-loop vector control that can be operated as a speed or torque control as required. The closed-loop vector control achieves the dynamic performance of a DC drive. This is made possible by the fact that the current components forming the torque and flux can be controlled precisely independently of each other. Prescribed torques can thus be observed and limited accurately. In the speed range from 1:10, the field-oriented closed-loop control does not require an actual speed value encoder.</p> <p>An actual speed value encoder is required in the following scenarios:</p> <ul style="list-style-type: none"> • High dynamics requirements • Torque control/constant torque drives with a control range > 1:10 • Very low speeds • Very high speed accuracy
Setpoint input	<p>The setpoint can be defined internally or externally; internally as a fixed setpoint, motorized potentiometer setpoint or jog setpoint, externally via the PROFINET interface or an analog input of the customer terminal block. The internal fixed setpoint and the motorized potentiometer setpoint can be switched over or adjusted using control commands via all of the interfaces.</p>
Ramp-function generator	<p>A user-friendly ramp-function generator with separately adjustable ramp-up and ramp-down times, together with variable smoothing times in the lower and upper speed ranges, improves the control response and therefore prevents mechanical overloading of the drive train. The ramp-down ramps can be parameterized separately for emergency stop.</p>

2.4 Function

SINAMICS GM150 in the IGBT version	Description
V_{dc max} controller	The V _{dc max} controller automatically prevents overvoltages in the DC link, if the set down ramp is too short, for example. This can also extend the set ramp-down time.
Kinetic buffering	Power supply failures are bridged to the extent permitted by the kinetic energy of the drive train. The speed drops depending on the moment of inertia and the load torque. The current speed setpoint is resumed when the power supply returns. This function can result in fast load changes, which can have a negative impact on the line supply (especially for weak line supplies, as is the case on board a ship). Kinetic buffering is not available when operating separately excited synchronous motors.
Automatic restart (option L32)	The automatic restart switches the drive on again when the power is restored after a power failure or a general fault, and ramps up to the actual speed setpoint.
Flying restart	The flying restart function permits smooth connection of the converter to a rotating motor.
Diagnostic functions	<ul style="list-style-type: none"> • Self-diagnosis of control hardware • Non-volatile memory for reliable diagnosis when the power supply fails • Monitoring of HV IGBTs with individual messages for each mounting location • User-friendly on-site operator panel with plain text messages
Operating hours and switching cycles counter	The operating hours of the non-redundant fans, which are located on the roof section of the cabinets, are detected and logged so that preventive maintenance can be performed or equipment replaced as a preventive measure. The switching cycles of the circuit breaker are recorded and added together, to form the basis of preventive maintenance work.
Sensing the actual motor speed (option K50)	The Sensor Module SMC30 can be used to sense the actual motor speed. The signals from the rotary pulse encoder are converted here and made available to the closed-loop control for evaluation via the DRIVE-CLiQ interface.
Operator protection	The cabinet doors of the power sections are fitted with electromagnetic locks. This prevents the cabinet doors being opened while hazardous voltages are connected inside the cabinet.
EMERGENCY OFF button	The converters are equipped as standard with an EMERGENCY OFF button with protective collar which is fitted in the cabinet door. The contacts of the button are connected in parallel to the terminal block so they can be integrated in a protection concept on the plant side. EMERGENCY OFF stop category 0 is set as standard for uncontrolled shutdown (IEC 60204-1). The function includes voltage disconnection of the converter output through the circuit breaker. The motor coasts in the process. (The auxiliary power circuits are <i>not</i> disconnected.) Optionally available: <ul style="list-style-type: none"> • EMERGENCY STOP Category 1 for a controlled shutdown (option L60) • Control of the "Safe Torque Off" function (option K80)
Insulation monitoring	The converters feature insulation monitoring of the complete electrical circuit from the secondary side of the transformer to the stator windings of the motor.
Monitoring the peripherals	An extensive package of options for I/O monitoring (from the transformer and the motor through to the auxiliaries) is available.

SINAMICS GM150 in the IGBT version	Description
Thermal overload protection	<p>An alarm message is issued first when the overtemperature threshold is reached. If the temperature rises further, either a shutdown is carried out or automatic influencing of the output current so that a reduction in the thermal load is achieved. Once the cause of the fault has been eliminated (e.g. cooling has been improved), the original operating values are automatically resumed.</p> <p>For instance, for air-cooled converters and when filter mats are used, the amount of pollution of the filter mats is monitored by measuring the differential pressure which is then signaled. In the case of water-cooled converters, the water temperature and flow rate are recorded at several points in the cooling circuit and evaluated. Extensive self-diagnostic functions signal faults and therefore protect the converter.</p>
Make-proof grounding switch (options L48, L49)	<p>If grounding on the infeed or motor side is required for safety and protection reasons, a motorized make-proof grounding switch can be ordered. For safety reasons, the converter controller locks these make-proof grounding switches against activation while voltage is still present. The control is integrated into the protection and monitoring chain of the converter. The make-proof grounding switches are inserted automatically when the standard make-proof grounding switches of the DC link are inserted.</p>

AOP30 operator panel



Fig. 2-8 AOP30 operator panel

The AOP30 operator panel is fitted into the cabinet door of the SINAMICS GM150 for operation, monitoring and commissioning.

It has the following features and characteristics:

- Graphical LCD display with backlighting for plain-text display and a bar display of process variables
- LEDs for displaying the operational status
- Help function describing causes of and remedies for faults and alarms
- Membrane keyboard with keypad for operational control of a drive
- Local/remote switchover to select the operator control location (priority assigned to operator panel or customer terminal block/PROFINET)
- Numeric keypad for input of setpoint or parameter values
- Function keys for prompted navigation in the menu
- Two-stage safety strategy to protect against accidental or unauthorized changes to settings. The keyboard lock disables operation of the drive from the operator panel, so that only parameter values and process variables can be displayed. A password can be used to prevent the unauthorized modification of converter parameters.

Many operator panel languages are saved on the CompactFlash card of the Control Unit (e.g. English, German, Spanish, Chinese).

2.5 Selection and ordering data

2.5.1 Air cooling

Type rating	Shaft output		Rated output current	SINAMICS GM150 in the IGBT version, air-cooling	Circuit version
	kVA	kW			
Output voltage 2.3 kV					
1600	1300	1750	400	6SL3810-2LM34-0AA4	1
1800	1500	2000	460	6SL3810-2LM34-6AA3	1
2100	1750	2400	530	6SL3810-2LM35-3AA3	1
2400	2000	2750	600	6SL3810-2LM36-0AA4	1
2700	2250	3100	700	6SL3810-2LM37-0AA3	1
3200	2650	3600	800	6SL3810-2LM38-0AA3	1
Output voltage 3.3 kV					
1000	850	1000	180	6SL3810-2LN31-8AA3	1
1300	1050	1250	220	6SL3810-2LN32-2AA3	1
1500	1250	1500	260	6SL3810-2LN32-6AA3	1
1700	1400	2000	300	6SL3810-2LN33-0AA3	1
2000	1650	2250	350	6SL3810-2LN33-5AA3	1
2300	1900	2500	400	6SL3810-2LN34-0AA3	1
2600	2150	3000	460	6SL3810-2LN34-6AA3	1
3000	2500	3380	530	6SL3810-2LN35-3AA3	1
3400	2850	3750	600	6SL3810-2LN36-0AA4	1
4000	3300	4500	700	6SL3810-2LN37-0AA3	1
4600	3800	5000	800	6SL3810-2LN38-0AA3	1
5300	4450	6200	2 × 465	6SL3810-2LN38-8AA4	3
6300	5300	7000	2 × 550	6SL3810-2LN41-1AA4	3
7100	6000	8000	2 × 625	6SL3810-2LN41-2AA3	3
8000	6700	9500	2 × 700	6SL3810-2LN41-4AA3	3
Output voltage 4.16 kV					
1300	1000	1500	180	6SL3810-2LP31-8AA3	1
1600	1300	1750	220	6SL3810-2LP32-2AA3	1
1900	1550	2000	260	6SL3810-2LP32-6AA3	1
2200	1800	2500	300	6SL3810-2LP33-0AA3	1
2500	2100	3000	350	6SL3810-2LP33-5AA3	1
2900	2400	3250	400	6SL3810-2LP34-0AA3	1
3300	2800	3800	460	6SL3810-2LP34-6AA3	1
3800	3100	4100	530	6SL3810-2LP35-3AA3	1
4300	3600	5000	600	6SL3810-2LP36-0AA4	1
5000	4150	5650	700	6SL3810-2LP37-0AA3	1
5800	4800	6600	800	6SL3810-2LP38-0AA3	1
6700	5650	7600	2 × 465	6SL3810-2LP38-8AA3	3
7900	6600	9000	2 × 550	6SL3810-2LP41-1AA4	3
9000	7600	10250	2 × 625	6SL3810-2LP41-2AA3	3
10100	8500	11500	2 × 700	6SL3810-2LP41-4AA3	3

2.5.2 Water cooling

Type rating	Shaft output		Rated output current	SINAMICS GM150 in the IGBT version, water-cooling	Circuit version
kVA	kW	hp	A	Article No.	Fig. No.
Output voltage 2.3 kV					
2400	2000	2750	600	6SL3815-2LM36-0AA3	1
2600	2150	2950	660	6SL3815-2LM36-6AA3	1
2900	2450	3250	740	6SL3815-2LM37-4AA4	1
3200	2650	3500	800	6SL3815-2LM38-0AA4	1
3500	2900	3850	880	6SL3815-2LM38-8AA3	1
4000	3300	4400	1000	6SL3815-2LM41-0AA3	1
Output voltage 3.3 kV					
2000	1650	2250	350	6SL3815-2LN33-5AA3	1
2300	1900	2500	400	6SL3815-2LN34-0AA3	1
2600	2150	3000	450	6SL3815-2LN34-5AA3	1
2900	2400	3250	500	6SL3815-2LN35-0AA3	1
3100	2650	3500	550	6SL3815-2LN35-5AA3	1
3400	2800	3800	600	6SL3815-2LN36-0AA3	1
3800	3150	4200	660	6SL3815-2LN36-6AA3	1
4200	3500	4500	740	6SL3815-2LN37-4AA3	1
4600	3800	5000	800	6SL3815-2LN38-0AA4	1
5100	4250	6000	880	6SL3815-2LN38-8AA3	1
5700	4700	6150	1000	6SL3815-2LN41-0AA3	1
6300	5300	7000	2 × 550	6SL3815-2LN41-1AA3	3
6800	5600	7400	2 × 600	6SL3815-2LN41-2AA3	3
7400	6200	8000	2 × 650	6SL3815-2LN41-3AA3	3
8000	6700	9000	2 × 700	6SL3815-2LN41-4AA3	3
9100	7600	10200	2 × 800	6SL3815-2LN41-6AA3	3
10300	8600	11500	2 × 900	6SL3815-2LN41-8AA3	3
3150	2650	3500	2 × 550	6SL3815-2LN41-1AB3	4
3400	2800	3700	2 × 600	6SL3815-2LN41-2AB3	4
3700	3100	4000	2 × 650	6SL3815-2LN41-3AB3	4
4000	3350	4500	2 × 700	6SL3815-2LN41-4AB3	4
4550	3800	5100	2 × 800	6SL3815-2LN41-6AB3	4
5150	4300	5750	2 × 900	6SL3815-2LN41-8AB3	4

Green highlighting: DC bus configuration with two motors connected to a common DC link (on request, also for more than two motors)

Type rating	Shaft output		Rated output current	SINAMICS GM150 in the IGBT version, water-cooling	Circuit version
kVA	kW	hp	A	Article No.	Fig. No.
Output voltage 4.16 kV					
2000	1700	2250	280	6SL3815-2LP32-8AA3	1
2200	1850	2500	310	6SL3815-2LP33-1AA3	1
2500	2100	2750	350	6SL3815-2LP33-5AA3	1
2900	2400	3000	400	6SL3815-2LP34-0AA3	1
3200	2700	3500	450	6SL3815-2LP34-5AA3	1
3600	3000	4000	500	6SL3815-2LP35-0AA3	1
4000	3300	4500	550	6SL3815-2LP35-5AA3	1
4300	3600	4850	600	6SL3815-2LP36-0AA3	1
4800	4000	5450	660	6SL3815-2LP36-6AA3	1
5300	4500	6000	740	6SL3815-2LP37-4AA3	1
5800	4800	6500	800	6SL3815-2LP38-0AA3	1
6400	5300	7150	880	6SL3815-2LP38-8AA3	1
7200	5900	8000	1000	6SL3815-2LP41-0AA3	1
7900	6600	9000	2 × 550	6SL3815-2LP41-1AA3	3
8600	7150	9500	2 × 600	6SL3815-2LP41-2AA3	3
9400	7900	10000	2 × 650	6SL3815-2LP41-3AA3	3
10100	8500	11000	2 × 700	6SL3815-2LP41-4AA3	3
11500	9600	13000	2 × 800	6SL3815-2LP41-6AA3	3
13000	11250	15300	2 × 900	6SL3815-2LP41-8AA3	3
3950	3300	4500	2 × 550	6SL3815-2LP41-1AB3	4
4300	3600	4850	2 × 600	6SL3815-2LP41-2AB3	4
4700	3950	5000	2 × 650	6SL3815-2LP41-3AB3	4
5050	4250	5500	2 × 700	6SL3815-2LP41-4AB3	4
5750	4800	6500	2 × 800	6SL3815-2LP41-6AB3	4
6500	5625	7650	2 × 900	6SL3815-2LP41-8AB3	4

Green highlighting: DC bus configuration with two motors connected to a common DC link (on request, also for more than two motors)

2.6 Technical specifications

2.6.1 General technical data

General technical data	
Power components	Diodes, IGBTs
Line-side converter	Basic Line Modules:
• Standard	Basic circuit 2.3 ... 4.16 kV: 12-pulse diode rectifier
	Parallel circuit 3.3 and 4.16 kV: 24-pulse diode rectifier
• Option	Basic circuit 2.3 ... 4.16 kV: 24-pulse diode rectifier
Motor-side converter	Motor Module: Inverter
Closed-loop control	Vector control
Drive quadrants	2 (driving 2 directions of rotation)
Electrically isolated power section/open-loop and closed-loop control	Fiber optic cable, isolating transformer
Auxiliary power supply (for fans, coolant pumps, precharging the DC link capacitors, open-loop and closed-loop control)	230 V 1 AC $\pm 10\%$, 50/60 Hz $\pm 3\%$ and 400 V 3 AC $\pm 10\%$, 50/60 Hz $\pm 3\%$ or another auxiliary voltage (options C30 to C55)
Installation altitude	≤ 1000 m above sea level: 100 % load capability > 1000 ... 4000 m above sea level: current derating required > 2000 ... 4000 m above sea level: voltage derating required in addition
Insulation	According to IEC 61800-5-1: Pollution degree 2 (without conductive pollution), condensation not permissible
Degree of protection	According to IEC 60529:
• Standard	IP22 (air cooling), IP43 (water cooling)
• Option	IP42 (air cooling), IP54 (water cooling)
Protection class	Protection class I acc. to IEC 61800-5-1
Shock-hazard protection	DIN EN 50274/VDE 0660 T514 and BGV A3 when used for the intended application
Interference emission	This drive unit is part of a PDS, Category C4 acc. to IEC 61800-3. It has not been designed to be connected to the public line supply. EMC disturbances can occur when connected to these line supplies. The essential requirements placed on EMC protection for the drive system should be secured using an EMC plan on the customer side.
Paint finish/color	Indoor requirements/RAL 7035, light gray

General technical data	
Applicable standards and directives <ul style="list-style-type: none"> Standards EU directives 	IEC 61800-3 IEC 61800-5-1 And if referenced in the standards above: IEC 61800-2 IEC 60146-1-1 IEC 60204-11, however, structuring principles and reference marking according to IEC 61346-1 instead of IEC 81346-1 2014/35/EU: Low Voltage Directive 2014/30/EU: Electromagnetic Compatibility
Conformity with other directives	EAC TR TC 020/2011 (electromagnetic compatibility) The converter rating plate has an EAC marking.
Air cooling	Forced air cooling with integrated fans
Water cooling	Water-water cooling unit, internal circuit, deionized water
Permissible coolant temperature (raw water) <ul style="list-style-type: none"> Inlet Discharge 	+5 ... +35 °C ¹⁾ +40 °C ²⁾

1) With derating also higher values (see section 2.6.2); values lower than +5 °C on request

2) Higher values on request

Rated data			
Output voltage	2.3 kV	3.3 kV	4.16 kV
Input voltage	2 x 1.2 kV	2 x 1.7 kV	2 x 2.2 kV
Input voltage tolerance	±10 %		
Line frequency	50/60 Hz ±5 %		
Line power factor fundamental mode	> 0.96		

Control-related properties	Operation of induction motors		Operation of separately excited synchronous motors
	Without encoder	With encoder	With encoder
Operating range			
Lower limit of speed control range (% of rated motor speed)	0 %	0 %	0 %
Max. permissible output frequency	250 Hz	250 Hz	90 Hz
Field weakening range	1:3	1:3	1:4
Steady-state operation			
Speed accuracy (% of rated motor speed)	±0.2 % (from 5 % of rated speed)	±0.01 %	±0.01 %
Torque accuracy (% of rated torque)	±5 % (from 5 % of rated speed)	±5 %	±2 %
Dynamic operation			
Torque rise time	5 ms	5 ms	5 ms

2.6 Technical specifications

	Storage	Transport	Operation
Climatic environmental conditions			
Ambient temperature	–25 ... +70 °C	–25 ... +70 °C	+5 ... +40 °C
Relative humidity	5 ... 95 % (only slight condensation permitted; converter must be completely dry before commissioning)	5 ... 95 % (only slight condensation permitted; converter must be completely dry before commissioning)	5 ... 85 % (condensation not permissible)
Other climatic conditions in accordance with Class	1K22 according to IEC 60721-3-1 (icing not permissible)	2K11 according to IEC 60721-3-2	3K22 according to IEC 60721-3-3
Degree of pollution	2 without conductive pollution according to IEC 61800-5-1	2 without conductive pollution according to IEC 61800-5-1	2 without conductive pollution according to IEC 61800-5-1
Mechanical environmental conditions			
in accordance with Class (increased strength for marine use)	1M11 according to IEC 60721-3-1	2M4 according to IEC 60721-3-2	3M11 according to IEC 60721-3-3
Other environmental conditions			
Biological environmental conditions in accordance with Class	1B1 according to IEC 60721-3-1	2B1 according to IEC 60721-3-2	3B1 according to IEC 60721-3-3 (without harmful flora)
Chemically active substances in accordance with Class	1C1 according to IEC 60721-3-1	2C1 according to IEC 60721-3-2	3C1 according to IEC 60721-3-3:1994 (no occurrence of salt mist)
Mechanically active substances in accordance with Class	1S11 according to IEC 60721-3-1	2S1 according to IEC 60721-3-2	3S6 according to IEC 60721-3-3

Note:

The values specified under storage and transport apply to suitably packed converters.

2.6.2 Derating for special installation conditions

Current derating

If the converters are operated at installation altitudes from 1000 m above sea level or at ambient/coolant temperatures > 40 °C for air cooling or with intake temperatures in the cooling unit > 35 °, derating factors k_H or k_T must be taken into account for the rated current (DIN 43671). The following applies for the permissible continuous current I :

$$I \leq I_N \times k_H \times k_T$$

I : permitted continuous current

I_N : rated current

The derating factors are shown in the following diagrams.

Note

The characteristics for installation altitudes up to 5000 m and higher ambient temperatures or raw water intake temperatures are available on request.

Current derating as a function of the installation altitude (air cooling)

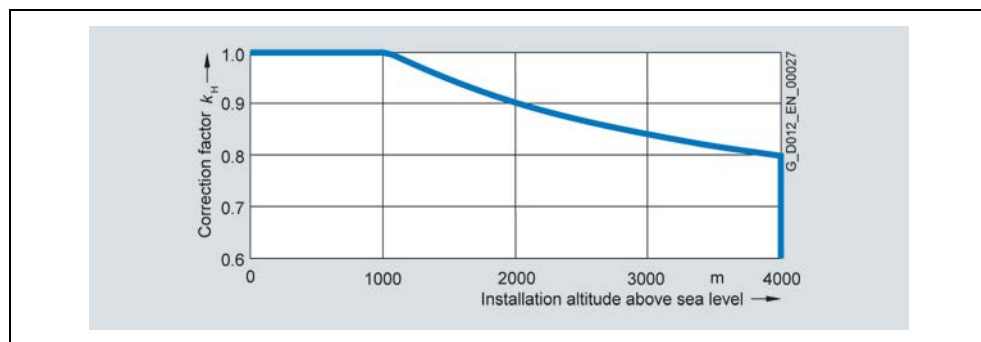

Fig. 2-9 Derating factor k_H for air cooling

Current derating as a function of the installation altitude (water cooling)

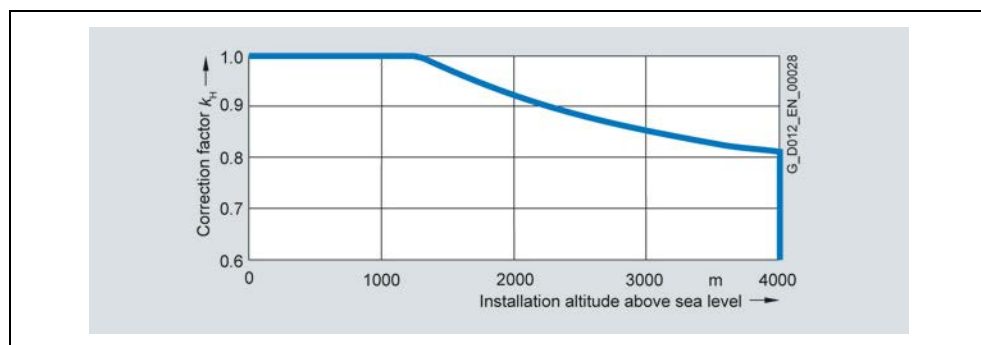

Fig. 2-10 Derating factor k_H for water cooling

Current derating as a function of the ambient temperature

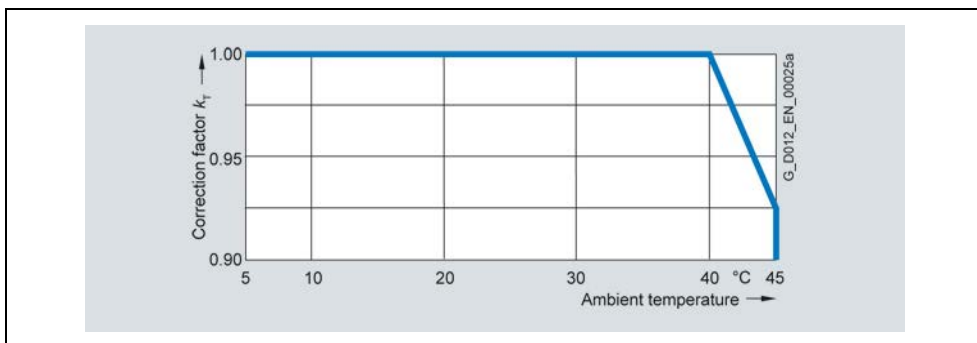

Fig. 2-11 Derating factor k_T (ambient temperature)

Current derating as a function of the raw water intake temperature

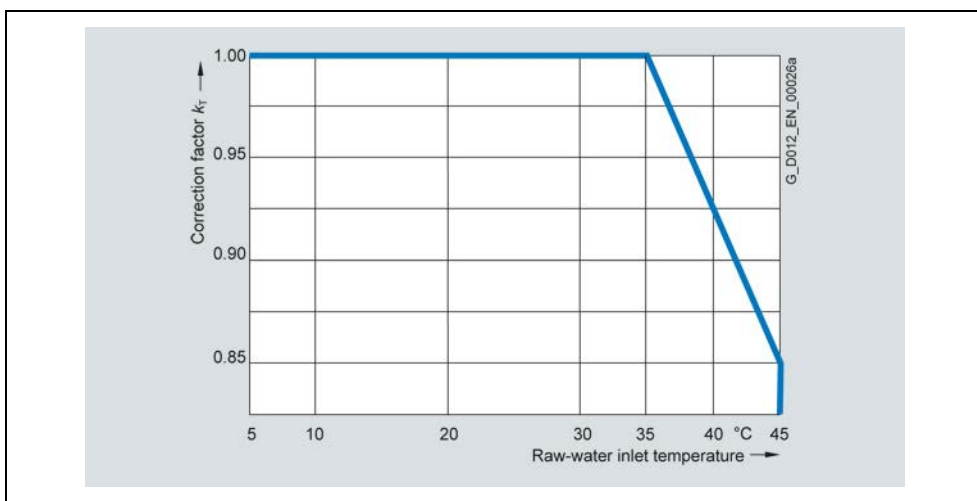

Fig. 2-12 Derating factor k_T (raw water intake temperature)

Voltage derating

For installation altitudes >2000 m, acc. to IEC 60664-1 in addition to a current derating, a voltage derating is also required. This depends on the air and creepage distances in the unit.

Voltage derating as a function of the installation altitude

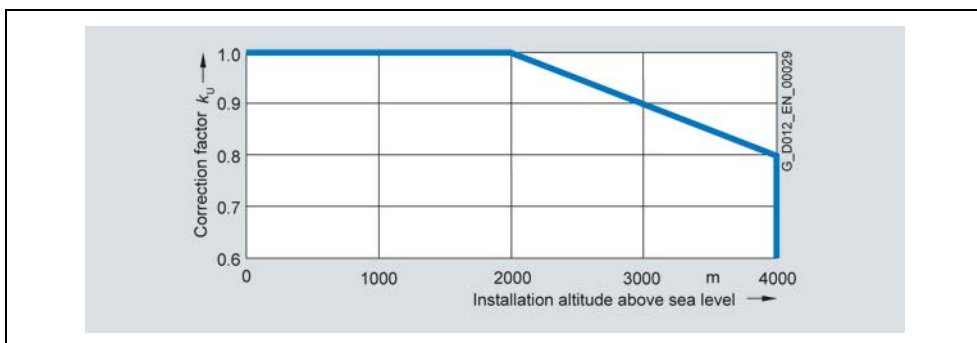

Fig. 2-13 Derating factor k_U

Example 1 (air-cooled converter)

Derating data SINAMICS GM150 in the IGBT version

Drive unit	6SL3810-2LP33-0AA3
Output voltage	4.16 kV
Input voltage	2 × 2, 2 kV
Type rating	2200 kVA, 300 A
Installation altitude	3000 m
Ambient temperature, max.	30 °C
k_H (air cooling)	0.84
k_T (ambient temperature)	1.0
k_U	0.9

For the current, the following applies:

$$I \leq I_N \times 0.84 \times 1.0 = I_N \times 0.84$$

A current derating of 16% and a voltage derating of 10% are required. The converter may still be connected to a line supply voltage of 2 x 1.98 kV 3 AC.

The maximum available output current is 252 A.

Example 2 (water-cooled converter)

Derating data SINAMICS GM150 in the IGBT version

Drive unit	6SL3815-2LN33-5AA3
Output voltage	3.3 kV
Input voltage	2 × 1.7 kV
Type rating	2000 kVA, 350 A
Installation altitude	2000 m
Raw water intake temperature	40 °C
k_H (water cooling)	0.925
k_T (raw water intake temperature)	0.925
k_U	1.0

For the current, the following applies:

$$I \leq I_N \times 0.925 \times 0.925 = I_N \times 0.856$$

A current derating of 14.4 % is required.

The maximum available output current is 299 A.

2.6.3 Type-specific technical data

The type-specific technical data for SINAMICS GM150 converters in the IGBT version are listed in the following tables.

- [Air cooling](#)
- [Water cooling](#)

SINAMICS GM150 in the IGBT version Air cooling		Article number: 6SL3810-...					
		...2LM34-0AA4	...2LM34-6AA3	...2LM35-3AA3	...2LM36-0AA4	...2LM37-0AA3	...2LM38-0AA3
Output voltage 2.3 kV							
Type rating	kVA	1600	1800	2100	2400	2700	3200
Shaft output ¹⁾	kW	1300	1500	1750	2000	2250	2650
	hp	1750	2000	2400	2750	3100	3600
Rated output current	A	400	460	530	600	700	800
Input voltage	kV	2 × 1,2	2 × 1,2	2 × 1,2	2 × 1,2	2 × 1,2	2 × 1,2
Rated input current ¹⁾	A	2 × 351	2 × 404	2 × 465	2 × 539	2 × 614	2 × 702
Power loss ²⁾	kW	24	27	29	34	33	37
Efficiency ²⁾	%	98.3	98.4	98.6	98.4	98.6	98.6
Typ. current demand of the auxiliary supply 230 V 1 AC 50/60 Hz ³⁾	A	2.5	2.5	2.5	2.5	2.5	2.5
Max. current demand of the auxiliary supply 400 V 3 AC 50/60 Hz ⁴⁾	A	27	27	27	27	27	27
Cooling air flow rate	m ³ /s	1.6	1.6	1.6	1.6	1.6	1.6
Sound pressure level L _{pA} (1m)	dB	80	80	80	80	80	80
Measuring surface level L _s (1m)	dB	18	18	18	18	18	18
Cable cross-sections, line-side, max. connectable per phase ^{5) 6)}	mm ² (DIN VDE)	4 × 240	4 × 240	4 × 240	4 × 240	4 × 240	4 × 240
	AWG/MCM (NEC,CEC)	4 × 500 MCM	4 × 500 MCM	4 × 500 MCM	4 × 500 MCM	4 × 500 MCM	4 × 500 MCM
Cable cross-sections, motor-side, max. connectable per phase ^{5) 6)}	mm ² (DIN VDE)	3 × 240	3 × 240	3 × 240	3 × 240	3 × 240	3 × 240
	AWG/MCM (NEC,CEC)	3 × 500 MCM	3 × 500 MCM	3 × 500 MCM	3 × 500 MCM	3 × 500 MCM	3 × 500 MCM
PE connection, max. cross-section at the enclosure with M12 screw ⁵⁾	mm ² (DIN VDE)	4 × 240	4 × 240	4 × 240	4 × 240	4 × 240	4 × 240
	AWG/MCM (NEC,CEC)	4 × 500 MCM	4 × 500 MCM	4 × 500 MCM	4 × 500 MCM	4 × 500 MCM	4 × 500 MCM
Degree of protection	–	IP22	IP22	IP22	IP22	IP22	IP22
Dimensions ⁷⁾	Width	mm	2420	2420	2420	2420	2420
	Height	mm	2570	2570	2570	2570	2570
	Depth	mm	1275	1275	1275	1275	1275
Circuit version	Fig. No.	1	1	1	1	1	1
Weight ⁷⁾	kg	1750	1750	1800	1800	1800	1800

1) The data for the rated input current and the power data in hp and kW are approximate values only; these have been calculated for operation with induction motors and for a typical motor power factor $\cos \varphi$ and motor efficiency, which are obtained by selecting the following values: Motor power factor between 0.85 and 0.88 and a motor efficiency of 96 %. The rated input current also depends on the line power factor, for which a typical value of between 0.94 and 0.96 was assumed.

The hp data are based on the NEC and CEC guidelines for the North American market. The kW values are specified in multiples of 50. Both approximate values need to be adapted to the motor which is actually used.

2) Without cooling system.

3) The typical current drawn (rms value; $\cos \varphi_{typ} = 0.6$) of the supply for the converter open-loop/closed-loop control is specified. The separate supplies for the socket outlets/light or switched auxiliary power feeders (options **N35** to **N38**) have not been taken into account.

Values for the typical current drawn for special configurations (e.g. for dimensioning an upstream UPS) are available on request.

When using options **L48** (make-proof grounding switch at the converter input), **L49** (make-proof grounding switch at the converter output) or **L51** (disconnecter at the converter output), it should further be taken into account that for switching operations, additional peak values of up to 10 A can occur for each make-proof grounding switch or disconnecter. This corresponds to the starting current of a motor used to operate a switch, which decays from approx. 10 A to approx. 2 A in 200 ms. A switching operation takes a total time of approx. 2 s. All optionally used make-proof grounding switches or disconnecters are controlled via the manually actuated make-proof grounding switch for the converter DC link (standard) and therefore switch simultaneously!

4) Additional 20 A precharging current for 25 s.

5) Data refer to a sub-system; for details about the number of sub-systems to be connected on the line or motor side, see circuit versions.

6) The maximum permissible cable lengths must be observed (see power cables 11.7).

7) The specified dimensions and weights include doors and panels, however no options.

2.6 Technical specifications

SINAMICS GM150 in the IGBT version Air cooling		Article number: 6SL3810-...				
		...2LN31-8AA3	...2LN32-2AA3	...2LN32-6AA3	...2LN33-0AA3	...2LN33-5AA3
Output voltage 3.3 kV						
Type rating	kVA	1000	1300	1500	1700	2000
Shaft output ¹⁾	kW	850	1050	1250	1400	1650
	hp	1000	1250	1500	2000	2250
Rated output current	A	180	220	260	300	350
Input voltage	kV	2 x 1.7	2 x 1.7	2 x 1.7	2 x 1.7	2 x 1.7
Rated input current ¹⁾	A	2 x 153	2 x 199	2 x 230	2 x 260	2 x 309
Power loss ²⁾	kW	12	15	17	19	22
Efficiency ²⁾	%	98.6	98.6	98.7	98.7	98.7
Typ. current demand of the auxiliary supply 230 V 1 AC 50/60 Hz ³⁾	A	2.5	2.5	2.5	2.5	2.5
Max. current demand of the auxiliary supply 400 V 3 AC 50/60 Hz ⁴⁾	A	27	27	27	27	27
Cooling air flow rate	m ³ /s	1.6	1.6	1.6	1.6	1.6
Sound pressure level L _{pA} (1m)	dB	78	80	80	80	80
Measuring surface level L _s (1m)	dB	18	18	18	18	18
Cable cross-sections, line-side, max. connectable per phase ^{5) 6)}	mm ² (DIN VDE)	4 x 240	4 x 240	4 x 240	4 x 240	4 x 240
	AWG/MCM (NEC,CEC)	4 x 500 MCM	4 x 500 MCM	4 x 500 MCM	4 x 500 MCM	4 x 500 MCM
Cable cross-sections, motor-side, max. connectable per phase ^{5) 6)}	mm ² (DIN VDE)	3 x 240	3 x 240	3 x 240	3 x 240	3 x 240
	AWG/MCM (NEC,CEC)	3 x 500 MCM	3 x 500 MCM	3 x 500 MCM	3 x 500 MCM	3 x 500 MCM
PE connection, max. cross-section at the enclosure with M12 screw ⁵⁾	mm ² (DIN VDE)	4 x 240	4 x 240	4 x 240	4 x 240	4 x 240
	AWG/MCM (NEC,CEC)	4 x 500 MCM	4 x 500 MCM	4 x 500 MCM	4 x 500 MCM	4 x 500 MCM
Degree of protection	–	IP22	IP22	IP22	IP22	IP22
Dimensions ⁷⁾	Width	mm	2420	2420	2420	2420
	Height	mm	2570	2570	2570	2570
	Depth	mm	1275	1275	1275	1275
Circuit version	Fig. No.	1	1	1	1	1
Weight ⁷⁾	kg	1800	1800	1800	1800	1800

1) The data for the rated input current and the power data in hp and kW are approximate values only; these have been calculated for operation with induction motors and for a typical motor power factor $\cos \varphi$ and motor efficiency, which are obtained by selecting the following values: Motor power factor between 0.85 and 0.88 and a motor efficiency of 96 %. The rated input current also depends on the line power factor, for which a typical value of between 0.94 and 0.96 was assumed.

The hp data are based on the NEC and CEC guidelines for the North American market. The kW values are specified in multiples of 50. Both approximate values need to be adapted to the motor which is actually used.

2) Without cooling system.

3) The typical current drawn (rms value; $\cos \varphi_{typ} = 0.6$) of the supply for the converter open-loop/closed-loop control is specified. The separate supplies for the socket outlets/light or switched auxiliary power feeders (options N35 to N38) have not been taken into account.

Values for the typical current drawn for special configurations (e.g. for dimensioning an upstream UPS) are available on request.

When using options L48 (make-proof grounding switch at the converter input), L49 (make-proof grounding switch at the converter output) or L51 (disconnecter at the converter output), it should further be taken into account that for switching operations, additional peak values of up to 10 A can occur for each make-proof grounding switch or disconnecter. This corresponds to the starting current of a motor used to operate a switch, which decays from approx. 10 A to approx. 2 A in 200 ms. A switching operation takes a total time of approx. 2 s. All optionally used make-proof grounding switches or disconnecters are controlled via the manually actuated make-proof grounding switch for the converter DC link (standard) and therefore switch simultaneously!

4) Additional 20 A precharging current for 25 s.

5) Data refer to a sub-system; for details about the number of sub-systems to be connected on the line or motor side, see circuit versions.

6) The maximum permissible cable lengths must be observed (see power cables 11.7).

7) The specified dimensions and weights include doors and panels, however no options.

SINAMICS GM150 in the IGBT version Air cooling		Article number: 6SL3810-...					
		...2LN34-0AA3	...2LN34-6AA3	...2LN35-3AA3	...2LN36-0AA4	...2LN37-0AA3	...2LN38-0AA3
Output voltage 3.3 kV							
Type rating	kVA	2300	2600	3000	3400	4000	4600
Shaft output ¹⁾	kW	1900	2150	2500	2850	3300	3800
	hp	2500	3000	3380	3750	4500	5000
Rated output current	A	400	460	530	600	700	800
Input voltage	kV	2 × 1.7	2 × 1.7	2 × 1.7	2 × 1.7	2 × 1.7	2 × 1.7
Rated input current ¹⁾	A	2 × 360	2 × 406	2 × 465	2 × 531	2 × 606	2 × 700
Power loss ²⁾	kW	25	34	39	44	45	52
Efficiency ²⁾	%	98.7	98.5	98.5	98.5	98.7	98.7
Typ. current demand of the auxiliary supply 230 V 1 AC 50/60 Hz ³⁾	A	2.5	2.5	2.5	2.5	2.5	2.5
Max. current demand of the auxiliary supply 400 V 3 AC 50/60 Hz ⁴⁾	A	27	27	27	27	27	27
Cooling air flow rate	m ³ /s	1.6	2.4	2.4	2.4	2.4	2.4
Sound pressure level L _{pA} (1m)	dB	80	80	80	80	80	80
Measuring surface level L _s (1m)	dB	18	18	18	18	18	18
Cable cross-sections, line-side, max. connectable per phase ^{5) 6)}	mm ² (DIN VDE)	4 × 240	4 × 240	4 × 240	4 × 240	4 × 240	4 × 240
	AWG/MCM (NEC,CEC)	4 × 500 MCM	4 × 500 MCM	4 × 500 MCM	4 × 500 MCM	4 × 500 MCM	4 × 500 MCM
Cable cross-sections, motor-side, max. connectable per phase ^{5) 6)}	mm ² (DIN VDE)	3 × 240	3 × 240	3 × 240	3 × 240	3 × 240	3 × 240
	AWG/MCM (NEC,CEC)	3 × 500 MCM	3 × 500 MCM	3 × 500 MCM	3 × 500 MCM	3 × 500 MCM	3 × 500 MCM
PE connection, max. cross-section at the enclosure with M12 screw ⁵⁾	mm ² (DIN VDE)	4 × 240	4 × 240	4 × 240	4 × 240	4 × 240	4 × 240
	AWG/MCM (NEC,CEC)	4 × 500 MCM	4 × 500 MCM	4 × 500 MCM	4 × 500 MCM	4 × 500 MCM	4 × 500 MCM
Degree of protection	–	IP22	IP22	IP22	IP22	IP22	IP22
Dimensions ⁷⁾	Width	mm	2420	2420	2420	2420	2420
	Height	mm	2570	2570	2570	2570	2570
	Depth	mm	1275	1275	1275	1275	1275
Circuit version	Fig. No.	1	1	1	1	1	1
Weight ⁷⁾	kg	1800	1950	1950	2000	2000	2000

1) The data for the rated input current and the power data in hp and kW are approximate values only; these have been calculated for operation with induction motors and for a typical motor power factor $\cos \phi$ and motor efficiency, which are obtained by selecting the following values: Motor power factor between 0.85 and 0.88 and a motor efficiency of 96 %. The rated input current also depends on the line power factor, for which a typical value of between 0.94 and 0.96 was assumed. The hp data are based on the NEC and CEC guidelines for the North American market. The kW values are specified in multiples of 50. Both approximate values need to be adapted to the motor which is actually used.

2) Without cooling system.

3) The typical current drawn (rms value; $\cos \phi_{typ} = 0.6$) of the supply for the converter open-loop/closed-loop control is specified. The separate supplies for the socket outlets/light or switched auxiliary power feeders (options N35 to N38) have not been taken into account.

Values for the typical current drawn for special configurations (e.g. for dimensioning an upstream UPS) are available on request.

When using options L48 (make-proof grounding switch at the converter input), L49 (make-proof grounding switch at the converter output) or L51 (disconnecter at the converter output), it should further be taken into account that for switching operations, additional peak values of up to 10 A can occur for each make-proof grounding switch or disconnecter. This corresponds to the starting current of a motor used to operate a switch, which decays from approx. 10 A to approx. 2 A in 200 ms. A switching operation takes a total time of approx. 2 s. All optionally used make-proof grounding switches or disconnecters are controlled via the manually actuated make-proof grounding switch for the converter DC link (standard) and therefore switch simultaneously!

4) Additional 20 A precharging current for 25 s.

5) Data refer to a sub-system; for details about the number of sub-systems to be connected on the line or motor side, see circuit versions.

6) The maximum permissible cable lengths must be observed (see power cables 11.7).

7) The specified dimensions and weights include doors and panels, however no options.

2.6 Technical specifications

SINAMICS GM150 in the IGBT version Air cooling		Article number: 6SL3810-...			
		...2LN38-8AA4	...2LN41-1AA4	...2LN41-2AA3	...2LN41-4AA3
Output voltage 3.3 kV					
Type rating	kVA	5300	6300	7100	8000
Shaft output ¹⁾	kW	4450	5300	6000	6700
	hp	6200	7000	8000	9500
Rated output current	A	2 × 465	2 × 550	2 × 625	2 × 700
Input voltage	kV	2 × (2 × 1.7)	2 × (2 × 1.7)	2 × (2 × 1.7)	2 × (2 × 1.7)
Rated input current ¹⁾	A	2 × (2 × 410)	2 × (2 × 492)	2 × (2 × 546)	2 × (2 × 611)
Power loss ²⁾	kW	70	82	83	96
Efficiency ²⁾	%	98.5	98.5	98.6	98.6
Typ. current demand of the auxiliary supply 230 V 1 AC 50/60 Hz ³⁾	A	4	4	4	4
Max. current demand of the auxiliary supply 400 V 3 AC 50/60 Hz ⁴⁾	A	54	54	54	54
Cooling air flow rate	m ³ /s	4.7	4.7	4.7	4.7
Sound pressure level L _{pA} (1m)	dB	85	85	85	85
Measuring surface level L _s (1m)	dB	18	19	18	18
Cable cross-sections, line-side, max. connectable per phase ^{5) 6)}	mm ² (DIN VDE)	4 × 240	4 × 240	4 × 240	4 × 240
	AWG/MCM (NEC,CEC)	4 × 500 MCM	4 × 500 MCM	4 × 500 MCM	4 × 500 MCM
Cable cross-sections, motor-side, max. connectable per phase ^{5) 6)}	mm ² (DIN VDE)	3 × 240	3 × 240	3 × 240	3 × 240
	AWG/MCM (NEC,CEC)	3 × 500 MCM	3 × 500 MCM	3 × 500 MCM	3 × 500 MCM
PE connection, max. cross-section at the enclosure with M12 screw ⁵⁾	mm ² (DIN VDE)	4 × 240	4 × 240	4 × 240	4 × 240
	AWG/MCM (NEC,CEC)	4 × 500 MCM	4 × 500 MCM	4 × 500 MCM	4 × 500 MCM
Degree of protection	–	IP22	IP22	IP22	IP22
Dimensions ⁷⁾	Width	mm	4220	4220	4220
	Height	mm	2570	2570	2570
	Depth	mm	1275	1275	1275
Circuit version	Fig. No.	3	3	3	3
Weight ⁷⁾	kg	3700	3700	3700	3700

1) The data for the rated input current and the power data in hp and kW are approximate values only; these have been calculated for operation with induction motors and for a typical motor power factor $\cos \varphi$ and motor efficiency, which are obtained by selecting the following values: Motor power factor between 0.85 and 0.88 and a motor efficiency of 96 %. The rated input current also depends on the line power factor, for which a typical value of between 0.94 and 0.96 was assumed.

The hp data are based on the NEC and CEC guidelines for the North American market. The kW values are specified in multiples of 50. Both approximate values need to be adapted to the motor which is actually used.

2) Without cooling system.

3) The typical current drawn (rms value; $\cos \varphi_{\text{typ}} = 0.6$) of the supply for the converter open-loop/closed-loop control is specified. The separate supplies for the socket outlets/light or switched auxiliary power feeders (options N35 to N38) have not been taken into account.

Values for the typical current drawn for special configurations (e.g. for dimensioning an upstream UPS) are available on request.

When using options L48 (make-proof grounding switch at the converter input), L49 (make-proof grounding switch at the converter output) or L51 (disconnecter at the converter output), it should further be taken into account that for switching operations, additional peak values of up to 10 A can occur for each make-proof grounding switch or disconnecter. This corresponds to the starting current of a motor used to operate a switch, which decays from approx. 10 A to approx. 2 A in 200 ms. A switching operation takes a total time of approx. 2 s. All optionally used make-proof grounding switches or disconnecters are controlled via the manually actuated make-proof grounding switch for the converter DC link (standard) and therefore switch simultaneously!

4) Additional 20 A precharging current for 25 s.

5) Data refer to a sub-system; for details about the number of sub-systems to be connected on the line or motor side, see circuit versions.

6) The maximum permissible cable lengths must be observed (see power cables 11.7).

7) The specified dimensions and weights include doors and panels, however no options.

SINAMICS GM150 in the IGBT version Air cooling		Article number: 6SL3810-...				
		...2LP31-8AA3	...2LP32-2AA3	...2LP32-6AA3	...2LP33-0AA3	...2LP33-5AA3
Output voltage 4.16 kV						
Type rating	kVA	1300	1600	1900	2200	2500
Shaft output ¹⁾	kW	1000	1300	1550	1800	2100
	hp	1500	1750	2000	2500	3000
Rated output current	A	180	220	260	300	350
Input voltage	kV	2 × 2.2	2 × 2.2	2 × 2.2	2 × 2.2	2 × 2.2
Rated input current ¹⁾	A	2 × 156	2 × 188	2 × 223	2 × 257	2 × 300
Power loss ²⁾	kW	17	19	21	23	26
Efficiency ²⁾	%	98.5	98.6	98.7	98.8	98.8
Typ. current demand of the auxiliary supply 230 V 1 AC 50/60 Hz ³⁾	A	2.5	2.5	2.5	2.5	2.5
Max. current demand of the auxiliary supply 400 V 3 AC 50/60 Hz ⁴⁾	A	27	27	27	27	27
Cooling air flow rate	m ³ /s	1.6	1.6	1.6	1.6	1.6
Sound pressure level L _{pA} (1m)	dB	78	78	78	80	80
Measuring surface level L _s (1m)	dB	18	18	18	18	18
Cable cross-sections, line-side, max. connectable per phase ^{5) 6)}	mm ² (DIN VDE)	4 × 240	4 × 240	4 × 240	4 × 240	4 × 240
	AWG/MCM (NEC,CEC)	4 × 500 MCM	4 × 500 MCM	4 × 500 MCM	4 × 500 MCM	4 × 500 MCM
Cable cross-sections, motor-side, max. connectable per phase ^{5) 6)}	mm ² (DIN VDE)	3 × 240	3 × 240	3 × 240	3 × 240	3 × 240
	AWG/MCM (NEC,CEC)	3 × 500 MCM	3 × 500 MCM	3 × 500 MCM	3 × 500 MCM	3 × 500 MCM
PE connection, max. cross-section at the enclosure with M12 screw ⁵⁾	mm ² (DIN VDE)	4 × 240	4 × 240	4 × 240	4 × 240	4 × 240
	AWG/MCM (NEC,CEC)	4 × 500 MCM	4 × 500 MCM	4 × 500 MCM	4 × 500 MCM	4 × 500 MCM
Degree of protection	–	IP22	IP22	IP22	IP22	IP22
Dimensions ⁷⁾	Width	mm	2420	2420	2420	2420
	Height	mm	2570	2570	2570	2570
	Depth	mm	1275	1275	1275	1275
Circuit version	Fig. No.	1	1	1	1	1
Weight ⁷⁾	kg	1800	1800	1800	1850	1850

1) The data for the rated input current and the power data in hp and kW are approximate values only; these have been calculated for operation with induction motors and for a typical motor power factor cos φ and motor efficiency, which are obtained by selecting the following values: Motor power factor between 0.85 and 0.88 and a motor efficiency of 96 %. The rated input current also depends on the line power factor, for which a typical value of between 0.94 and 0.96 was assumed. The hp data are based on the NEC and CEC guidelines for the North American market. The kW values are specified in multiples of 50. Both approximate values need to be adapted to the motor which is actually used.

2) Without cooling system.

3) The typical current drawn (rms value; cosφ_{typ.} = 0.6) of the supply for the converter open-loop/closed-loop control is specified. The separate supplies for the socket outlets/light or switched auxiliary power feeders (options N35 to N38) have not been taken into account.

Values for the typical current drawn for special configurations (e.g. for dimensioning an upstream UPS) are available on request. When using options L48 (make-proof grounding switch at the converter input), L49 (make-proof grounding switch at the converter output) or L51 (disconnecter at the converter output), it should further be taken into account that for switching operations, additional peak values of up to 10 A can occur for each make-proof grounding switch or disconnecter. This corresponds to the starting current of a motor used to operate a switch, which decays from approx. 10 A to approx. 2 A in 200 ms. A switching operation takes a total time of approx. 2 s. All optionally used make-proof grounding switches or disconnecters are controlled via the manually actuated make-proof grounding switch for the converter DC link (standard) and therefore switch simultaneously!

4) Additional 20 A precharging current for 25 s.

5) Data refer to a sub-system; for details about the number of sub-systems to be connected on the line or motor side, see circuit versions.

6) The maximum permissible cable lengths must be observed (see power cables 11.7).

7) The specified dimensions and weights include doors and panels, however no options.

2.6 Technical specifications

SINAMICS GM150 in the IGBT version Air cooling		Article number: 6SL3810-...					
		...2LP34-0AA3	...2LP34-6AA3	...2LP35-3AA3	...2LP36-0AA4	...2LP37-0AA3	...2LP38-0AA3
Output voltage 4.16 kV							
Type rating	kVA	2900	3300	3800	4300	5000	5800
Shaft output ¹⁾	kW	2400	2800	3100	3600	4150	4800
	hp	3250	3800	4100	5000	5650	6600
Rated output current	A	400	460	530	600	700	800
Input voltage	kV	2 × 2.2	2 × 2.2	2 × 2.2	2 × 2.2	2 × 2.2	2 × 2.2
Rated input current ¹⁾	A	2 × 342	2 × 394	2 × 453	2 × 533	2 × 600	2 × 700
Power loss ²⁾	kW	29	32	36	56	51	56
Efficiency ²⁾	%	98.8	98.9	98.9	98.5	98.8	98.8
Typ. current demand of the auxiliary supply 230 V 1 AC 50/60 Hz ³⁾	A	2.5	2.5	2.5	2.5	2.5	2.5
Max. current demand of the auxiliary supply 400 V 3 AC 50/60 Hz ⁴⁾	A	27	27	27	27	27	27
Cooling air flow rate	m ³ /s	1.6	1.6	1.6	2.4	2.4	2.4
Sound pressure level L _{pA} (1m)	dB	80	80	80	80	80	80
Measuring surface level L _s (1m)	dB	18	18	18	18	18	18
Cable cross-sections, line-side, max. connectable per phase ^{5) 6)}	mm ² (DIN VDE)	4 × 240	4 × 240	4 × 240	4 × 240	4 × 240	4 × 240
	AWG/MCM (NEC,CEC)	4 × 500 MCM	4 × 500 MCM	4 × 500 MCM	4 × 500 MCM	4 × 500 MCM	4 × 500 MCM
Cable cross-sections, motor-side, max. connectable per phase ^{5) 6)}	mm ² (DIN VDE)	3 × 240	3 × 240	3 × 240	3 × 240	3 × 240	3 × 240
	AWG/MCM (NEC,CEC)	3 × 500 MCM	3 × 500 MCM	3 × 500 MCM	3 × 500 MCM	3 × 500 MCM	3 × 500 MCM
PE connection, max. cross-section at the enclosure with M12 screw ⁵⁾	mm ² (DIN VDE)	4 × 240	4 × 240	4 × 240	4 × 240	4 × 240	4 × 240
	AWG/MCM (NEC,CEC)	4 × 500 MCM	4 × 500 MCM	4 × 500 MCM	4 × 500 MCM	4 × 500 MCM	4 × 500 MCM
Degree of protection	–	IP22	IP22	IP22	IP22	IP22	IP22
Dimensions ⁷⁾	Width	mm	2420	2420	2420	2420	2420
	Height	mm	2570	2570	2570	2570	2570
	Depth	mm	1275	1275	1275	1275	1275
Circuit version	Fig. No.	1	1	1	1	1	1
Weight ⁷⁾	kg	1850	1900	1900	2000	2000	2000

1) The data for the rated input current and the power data in hp and kW are approximate values only; these have been calculated for operation with induction motors and for a typical motor power factor $\cos \varphi$ and motor efficiency, which are obtained by selecting the following values: Motor power factor between 0.85 and 0.88 and a motor efficiency of 96 %. The rated input current also depends on the line power factor, for which a typical value of between 0.94 and 0.96 was assumed. The hp data are based on the NEC and CEC guidelines for the North American market. The kW values are specified in multiples of 50. Both approximate values need to be adapted to the motor which is actually used.

2) Without cooling system.

3) The typical current drawn (rms value; $\cos \varphi_{typ} = 0.6$) of the supply for the converter open-loop/closed-loop control is specified. The separate supplies for the socket outlets/light or switched auxiliary power feeders (options N35 to N38) have not been taken into account.

4) Additional 20 A precharging current for 25 s.

5) Data refer to a sub-system; for details about the number of sub-systems to be connected on the line or motor side, see circuit versions.

6) The maximum permissible cable lengths must be observed (see power cables 11.7).

7) The specified dimensions and weights include doors and panels, however no options.

Values for the typical current drawn for special configurations (e.g. for dimensioning an upstream UPS) are available on request. When using options L48 (make-proof grounding switch at the converter input), L49 (make-proof grounding switch at the converter output) or L51 (disconnecter at the converter output), it should further be taken into account that for switching operations, additional peak values of up to 10 A can occur for each make-proof grounding switch or disconnecter. This corresponds to the starting current of a motor used to operate a switch, which decays from approx. 10 A to approx. 2 A in 200 ms. A switching operation takes a total time of approx. 2 s. All optionally used make-proof grounding switches or disconnecters are controlled via the manually actuated make-proof grounding switch for the converter DC link (standard) and therefore switch simultaneously!

4) Additional 20 A precharging current for 25 s.

5) Data refer to a sub-system; for details about the number of sub-systems to be connected on the line or motor side, see circuit versions.

6) The maximum permissible cable lengths must be observed (see power cables 11.7).

7) The specified dimensions and weights include doors and panels, however no options.

SINAMICS GM150 in the IGBT version Air cooling		Article number: 6SL3810-...			
		...2LP38-8AA3	...2LP41-1AA4	...2LP41-2AA3	...2LP41-4AA3
Output voltage 4.16 kV					
Type rating	kVA	6700	7900	9000	10100
Shaft output ¹⁾	kW	5650	6600	7600	8500
	hp	7600	9000	10250	11500
Rated output current	A	2 × 465	2 × 550	2 × 625	2 × 700
Input voltage	kV	2 × (2 × 2.2)	2 × (2 × 2.2)	2 × (2 × 2.2)	2 × (2 × 2.2)
Rated input current ¹⁾	A	2 × (2 × 410)	2 × (2 × 490)	2 × (2 × 543)	2 × (2 × 608)
Power loss ²⁾	kW	77	103	93	106
Efficiency ²⁾	%	98.7	98.5	98.8	98.8
Typ. current demand of the auxiliary supply 230 V 1 AC 50/60 Hz ³⁾	A	4	4	4	4
Max. current demand of the auxiliary supply 400 V 3 AC 50/60 Hz ⁴⁾	A	54	54	54	54
Cooling air flow rate	m ³ /s	4.7	4.7	4.7	4.7
Sound pressure level L _{PA} (1m)	dB	85	85	85	85
Measuring surface level L _s (1m)	dB	19	19	19	19
Cable cross-sections, line-side, max. connectable per phase ^{5) 6)}	mm ² (DIN VDE)	4 × 240	4 × 240	4 × 240	4 × 240
	AWG/MCM (NEC,CEC)	4 × 500 MCM	4 × 500 MCM	4 × 500 MCM	4 × 500 MCM
Cable cross-sections, motor-side, max. connectable per phase ^{5) 6)}	mm ² (DIN VDE)	3 × 240	3 × 240	3 × 240	3 × 240
	AWG/MCM (NEC,CEC)	3 × 500 MCM	3 × 500 MCM	3 × 500 MCM	3 × 500 MCM
PE connection, max. cross-section at the enclosure with M12 screw ⁵⁾	mm ² (DIN VDE)	4 × 240	4 × 240	4 × 240	4 × 240
	AWG/MCM (NEC,CEC)	4 × 500 MCM	4 × 500 MCM	4 × 500 MCM	4 × 500 MCM
Degree of protection	–	IP22	IP22	IP22	IP22
Dimensions ⁷⁾	Width	mm	4220	4220	4220
	Height	mm	2570	2570	2570
	Depth	mm	1275	1275	1275
Circuit version	Fig. No.	3	3	3	3
Weight ⁷⁾	kg	3700	3700	3700	3700

1) The data for the rated input current and the power data in hp and kW are approximate values only; these have been calculated for operation with induction motors and for a typical motor power factor $\cos \varphi$ and motor efficiency, which are obtained by selecting the following values: Motor power factor between 0.85 and 0.88 and a motor efficiency of 96 %. The rated input current also depends on the line power factor, for which a typical value of between 0.94 and 0.96 was assumed. The hp data are based on the NEC and CEC guidelines for the North American market. The kW values are specified in multiples of 50. Both approximate values need to be adapted to the motor which is actually used.

2) Without cooling system.

3) The typical current drawn (rms value; $\cos \varphi_{typ} = 0.6$) of the supply for the converter open-loop/closed-loop control is specified. The separate supplies for the socket outlets/light or switched auxiliary power feeders (options **N35** to **N38**) have not been taken into account.

Values for the typical current drawn for special configurations (e.g. for dimensioning an upstream UPS) are available on request.

When using options **L48** (make-proof grounding switch at the converter input), **L49** (make-proof grounding switch at the converter output) or **L51** (disconnecter at the converter output), it should further be taken into account that for switching operations, additional peak values of up to 10 A can occur for each make-proof grounding switch or disconnecter. This corresponds to the starting current of a motor used to operate a switch, which decays from approx. 10 A to approx. 2 A in 200 ms. A switching operation takes a total time of approx. 2 s. All optionally used make-proof grounding switches or disconnecters are controlled via the manually actuated make-proof grounding switch for the converter DC link (standard) and therefore switch simultaneously!

4) Additional 20 A precharging current for 25 s.

5) Data refer to a sub-system; for details about the number of sub-systems to be connected on the line or motor side, see circuit versions.

6) The maximum permissible cable lengths must be observed (see power cables 11.7).

7) The specified dimensions and weights include doors and panels, however no options.

2.6 Technical specifications

SINAMICS GM150 in IGBT version Water cooling		Article number: 6SL3815-...					
		...2LM36-0AA3	...2LM36-6AA3	...2LM37-4AA4	...2LM38-0AA4	...2LM38-8AA3	...2LM41-0AA3
Output voltage 2.3 kV							
Type rating	kVA	2400	2600	2900	3200	3500	4000
Shaft output ¹⁾	kW	2000	2150	2450	2650	2900	3300
	hp	2750	2950	3250	3500	3850	4400
Rated output current	A	600	660	740	800	880	1000
Input voltage	kV	2 × 1.2	2 × 1.2	2 × 1.2	2 × 1.2	2 × 1.2	2 × 1.2
Rated input current ¹⁾	A	2 × 519	2 × 575	2 × 650	2 × 717	2 × 771	2 × 870
Power loss ^{2) 3)}	kW	33	34	38	42	42	44
Efficiency ³⁾	%	98.4	98.4	98.5	98.5	98.6	98.7
Typical current demand of the auxiliary supply 230 V 1 AC 50/60 Hz ⁴⁾	A	2.5	2.5	2.5	2.5	2.5	2.5
Max. current demand of the auxiliary supply 400 V 3 AC 50/60 Hz ⁵⁾	A	25	25	25	25	25	25
Raw water flow rate	l/min	117	117	117	117	117	117
Deionized water volume	l	90	90	90	90	90	90
Sound pressure level L _{pA} (1m)	dB	73	73	73	73	73	73
Measuring surface level L _s (1m)	dB	18	18	18	18	18	18
Cable cross-sections, line-side, max. connectable per phase ^{6) 7)}	mm ² (DIN VDE)	4 × 240	4 × 240	4 × 240	4 × 240	4 × 240	4 × 240
	AWG/MCM (NEC, CEC)	4 × 500 MCM	4 × 500 MCM	4 × 500 MCM	4 × 500 MCM	4 × 500 MCM	4 × 500 MCM
Cable cross-sections, motor-side, max. connectable per phase ^{6) 7)}	mm ² (DIN VDE)	3 × 240	3 × 240	3 × 240	3 × 240	3 × 240	3 × 240
	AWG/MCM (NEC, CEC)	3 × 500 MCM	3 × 500 MCM	3 × 500 MCM	3 × 500 MCM	3 × 500 MCM	3 × 500 MCM
PE connection, max. cross-section at the enclosure with M12 screw ⁶⁾	mm ² (DIN VDE)	4 × 240	4 × 240	4 × 240	4 × 240	4 × 240	4 × 240
	AWG/MCM (NEC, CEC)	4 × 500 MCM	4 × 500 MCM	4 × 500 MCM	4 × 500 MCM	4 × 500 MCM	4 × 500 MCM
Degree of protection	–	IP43	IP43	IP43	IP43	IP43	IP43
Dimensions ⁸⁾	Width	mm	3620	3620	3620	3620	3620
	Height	mm	2280	2280	2280	2280	2280
	Depth	mm	1275	1275	1275	1275	1275
Circuit version	Fig. No.	1	1	1	1	1	1
Weight ⁸⁾	kg	2650	2650	2700	2700	2700	2700

1) The data for the rated input current and the power data in hp and kW are approximate values only; these have been calculated for operation with induction motors and for a typical motor power factor $\cos \varphi$ and motor efficiency, which are obtained by selecting the following values: Motor power factor between 0.85 and 0.88 and a motor efficiency of 96 %. The rated input current also depends on the line power factor, for which a typical value of between 0.94 and 0.96 was assumed. The hp data are based on the NEC and CEC guidelines for the North American market. The kW values are specified in multiples of 50. Both approximate values need to be adapted to the motor that is actually used.

2) Approx. 5% of the power loss is dissipated to the room.

3) Without cooling system

4) The typical current drawn (rms value; $\cos \varphi_{typ.} = 0.6$) of the supply for the converter open-loop/closed-loop control is specified. The separate supplies for the socket outlets/light or switched auxiliary power feeders (options N35 to N38) have not been taken into account.

Values for the typical current drawn for special configurations (e.g. for dimensioning an upstream UPS) are available on request.

When using options L48 (make-proof grounding switch at the converter input), L49 (make-proof grounding switch at the converter output) or L51 (disconnecter at the converter output), it should further be taken into account that for switching operations, additional peak values of up to 10 A can occur for each make-proof grounding switch or disconnecter. This corresponds to the starting current of a motor used to operate a switch, which decays from approx. 10 A to approx. 2 A in 200 ms. A switching operation takes a total time of approx. 2 s. All optionally used make-proof grounding switches or disconnecters are controlled via the manually actuated make-proof grounding switch for the converter DC link (standard) and therefore switch simultaneously!

5) Additional 20 A precharging current for 25 s.

6) Data refer to a sub-system; for details about the number of sub-systems to be connected on the line or motor side, see circuit versions.

7) The maximum permissible cable lengths should be carefully observed (see power cables 11.7).

8) The specified dimensions and weights include doors, panels and cooling unit, however no options.

SINAMICS GM150 in the IGBT version Water cooling		Article number: 6SL3815-...				
		...2LN33-5AA3	...2LN34-0AA3	...2LN34-5AA3	...2LN35-0AA3	...2LN35-5AA3
Output voltage 3.3 kV						
Type rating	kVA	2000	2300	2600	2900	3100
Shaft output ¹⁾	kW	1650	1900	2150	2400	2650
	hp	2250	2500	3000	3250	3500
Rated output current	A	350	400	450	500	550
Input voltage	kV	2 × 1.7	2 × 1.7	2 × 1.7	2 × 1.7	2 × 1.7
Rated input current ¹⁾	A	2 × 309	2 × 360	2 × 406	2 × 453	2 × 484
Power loss ^{2) 3)}	kW	22	25	28	31	34
Efficiency ³⁾	%	98.7	98.7	98.7	98.7	98.7
Typical current demand of the auxiliary supply 230 V 1 AC 50/60 Hz ⁴⁾	A	2.5	2.5	2.5	2.5	2.5
Max. current demand of the auxiliary supply 400 V 3 AC 50/60 Hz ⁵⁾	A	14	14	14	14	14
Raw water flow rate	l/min	117	117	117	117	117
Deionized water volume	l	90	90	90	90	90
Sound pressure level L _{pA} (1m)	dB	73	73	73	73	73
Measuring surface level L _s (1m)	dB	18	18	18	18	18
Cable cross-sections, line-side, max. connectable per phase ^{6) 7)}	mm ² (DIN VDE)	4 × 240	4 × 240	4 × 240	4 × 240	4 × 240
	AWG/MCM (NEC,CEC)	4 × 500 MCM	4 × 500 MCM	4 × 500 MCM	4 × 500 MCM	4 × 500 MCM
Cable cross-sections, motor-side, max. connectable per phase ^{6) 7)}	mm ² (DIN VDE)	3 × 240	3 × 240	3 × 240	3 × 240	3 × 240
	AWG/MCM (NEC,CEC)	3 × 500 MCM	3 × 500 MCM	3 × 500 MCM	3 × 500 MCM	3 × 500 MCM
PE connection, max. cross-section at the enclosure with M12 screw ⁶⁾	mm ² (DIN VDE)	4 × 240	4 × 240	4 × 240	4 × 240	4 × 240
	AWG/MCM (NEC,CEC)	4 × 500 MCM	4 × 500 MCM	4 × 500 MCM	4 × 500 MCM	4 × 500 MCM
Degree of protection	–	IP43	IP43	IP43	IP43	IP43
Dimensions ⁸⁾	Width	mm	3620	3620	3620	3620
	Height	mm	2280	2280	2280	2280
	Depth	mm	1275	1275	1275	1275
Circuit version	Fig. No.	1	1	1	1	1
Weight ⁸⁾	kg	2650	2700	2700	2700	2750

1) The data for the rated input current and the power data in hp and kW are approximate values only; these have been calculated for operation with induction motors and for a typical motor power factor $\cos \varphi$ and motor efficiency, which are obtained by selecting the following values: Motor power factor between 0.85 and 0.88 and a motor efficiency of 96 %. The rated input current also depends on the line power factor, for which a typical value of between 0.94 and 0.96 was assumed. The hp data are based on the NEC and CEC guidelines for the North American market. The kW values are specified in multiples of 50. Both approximate values need to be adapted to the motor that is actually used.

2) Approx. 5% of the power loss is dissipated to the room.

3) Without cooling system

4) The typical current drawn (rms value; $\cos \varphi_{typ} = 0.6$) of the supply for the converter open-loop/closed-loop control is specified. The separate supplies for the socket outlets/light or switched auxiliary power feeders (options N35 to N38) have not been taken into account.

Values for the typical current drawn for special configurations (e.g. for dimensioning an upstream UPS) are available on request.

When using options L48 (make-proof grounding switch at the converter input), L49 (make-proof grounding switch at the converter output) or L51 (disconnecter at the converter output), it should further be taken into account that for switching operations, additional peak values of up to 10 A can occur for each make-proof grounding switch or disconnecter. This corresponds to the starting current of a motor used to operate a switch, which decays from approx. 10 A to approx. 2 A in 200 ms. A switching operation takes a total time of approx. 2 s. All optionally used make-proof grounding switches or disconnecters are controlled via the manually actuated make-proof grounding switch for the converter DC link (standard) and therefore switch simultaneously!

5) Additional 20 A precharging current for 25 s.

6) Data refer to a sub-system; for details about the number of sub-systems to be connected on the line or motor side, see circuit versions.

7) The maximum permissible cable lengths should be carefully observed (see power cables 11.7).

8) The specified dimensions and weights include doors, panels and cooling unit, however no options.

2.6 Technical specifications

SINAMICS GM150 in the IGBT version Water cooling		Article number: 6SL3815-...					
		...2LN36-0AA3	...2LN36-6AA3	...2LN37-4AA3	...2LN38-0AA4	...2LN38-8AA3	...2LN41-0AA3
Output voltage 3.3 kV							
Type rating	kVA	3400	3800	4200	4600	5100	5700
Shaft output ¹⁾	kW	2800	3150	3500	3800	4250	4700
	hp	3800	4200	4500	5000	6000	6150
Rated output current	A	600	660	740	800	880	1000
Input voltage	kV	2 × 1.7	2 × 1.7	2 × 1.7	2 × 1.7	2 × 1.7	2 × 1.7
Rated input current ¹⁾	A	2 × 521	2 × 575	2 × 656	2 × 719	2 × 756	2 × 870
Power loss ^{2) 3)}	kW	37	41	46	60	56	63
Efficiency ³⁾	%	98.7	98.7	98.7	98.5	98.7	98.7
Typical current demand of the auxiliary supply 230 V 1 AC 50/60 Hz ⁴⁾	A	2.5	2.5	2.5	2.5	2.5	2.5
Max. current demand of the auxiliary supply 400 V 3 AC 50/60 Hz ⁵⁾	A	25	25	25	25	25	25
Raw water flow rate	l/min	117	117	117	183	183	183
Deionized water volume	l	90	90	90	90	90	90
Sound pressure level L _{pA} (1m)	dB	73	73	73	73	73	73
Measuring surface level L _s (1m)	dB	18	18	18	18	18	18
Cable cross-sections, line-side, max. connectable per phase ^{6) 7)}	mm ² (DIN VDE)	4 × 240	4 × 240	4 × 240	4 × 240	4 × 240	4 × 240
	AWG/MCM (NEC,CEC)	4 × 500 MCM	4 × 500 MCM	4 × 500 MCM	4 × 500 MCM	4 × 500 MCM	4 × 500 MCM
Cable cross-sections, motor-side, max. connectable per phase ^{6) 7)}	mm ² (DIN VDE)	3 × 240	3 × 240	3 × 240	3 × 240	3 × 240	3 × 240
	AWG/MCM (NEC,CEC)	3 × 500 MCM	3 × 500 MCM	3 × 500 MCM	3 × 500 MCM	3 × 500 MCM	3 × 500 MCM
PE connection, max. cross-section at the enclosure with M12 screw ⁶⁾	mm ² (DIN VDE)	4 × 240	4 × 240	4 × 240	4 × 240	4 × 240	4 × 240
	AWG/MCM (NEC,CEC)	4 × 500 MCM	4 × 500 MCM	4 × 500 MCM	4 × 500 MCM	4 × 500 MCM	4 × 500 MCM
Degree of protection	–	IP43	IP43	IP43	IP43	IP43	IP43
Dimensions ⁸⁾	Width	mm	3620	3620	3620	3620	3620
	Height	mm	2280	2280	2280	2280	2280
	Depth	mm	1275	1275	1275	1275	1275
Circuit version	Fig. No.	1	1	1	1	1	1
Weight ⁸⁾	kg	2750	2750	2750	2850	2850	2850

1) The data for the rated input current and the power data in hp and kW are approximate values only; these have been calculated for operation with induction motors and for a typical motor power factor $\cos \varphi$ and motor efficiency, which are obtained by selecting the following values: Motor power factor between 0.85 and 0.88 and a motor efficiency of 96 %. The rated input current also depends on the line power factor, for which a typical value of between 0.94 and 0.96 was assumed.

The hp data are based on the NEC and CEC guidelines for the North American market. The kW values are specified in multiples of 50. Both approximate values need to be adapted to the motor which is actually used.

2) Approx. 5% of the power loss is dissipated to the room.

3) Without cooling system

4) The typical current drawn (rms value; $\cos \varphi_{\text{typ.}} = 0.6$) of the supply for the converter open-loop/closed-loop control is specified. The separate supplies for the socket outlets/light or switched auxiliary power feeders (options N35 to N38) have not been taken into account.

Values for the typical current drawn for special configurations (e.g. for dimensioning an upstream UPS) are available on request.

When using options L48 (make-proof grounding switch at the converter input), L49 (make-proof grounding switch at the converter output) or L51 (disconnecter at the converter output), it should further be taken into account that for switching operations, additional peak values of up to 10 A can occur for each make-proof grounding switch or disconnecter. This corresponds to the starting current of a motor used to operate a switch, which decays from approx. 10 A to approx. 2 A in 200 ms. A switching operation takes a total time of approx. 2 s. All optionally used make-proof grounding switches or disconnecters are controlled via the manually actuated make-proof grounding switch for the converter DC link (standard) and therefore switch simultaneously!

5) Additional 20 A precharging current for 25 s.

6) Data refer to a sub-system; for details about the number of sub-systems to be connected on the line or motor side, see circuit versions.

7) The maximum permissible cable lengths should be carefully observed (see power cables 11.7).

8) The specified dimensions and weights include doors, panels and cooling unit, however no options.

SINAMICS GM150 in the IGBT version Water cooling		Article number: 6SL3815-...					
		...2LN41-1AA3	...2LN41-2AA3	...2LN41-3AA3	...2LN41-4AA3	...2LN41-6AA3	...2LN41-8AA3
Output voltage 3.3 kV							
Type rating	kVA	6300	6800	7400	8000	9100	10300
Shaft output ¹⁾	kW	5300	5600	6200	6700	7600	8600
	hp	7000	7400	8000	9000	10200	11500
Rated output current	A	2 × 550	2 × 600	2 × 650	2 × 700	2 × 800	2 × 900
Input voltage	kV	2 × (2 × 1.7)	2 × (2 × 1.7)	2 × (2 × 1.7)	2 × (2 × 1.7)	2 × (2 × 1.7)	2 × (2 × 1.7)
Rated input current ¹⁾	A	2 × (2 × 492)	2 × (2 × 536)	2 × (2 × 578)	2 × (2 × 625)	2 × (2 × 671)	2 × (2 × 784)
Power loss ^{2) 3)}	kW	68	75	83	90	104	117
Efficiency ³⁾	%	98.7	98.7	98.7	98.7	98.7	98.7
Typical current demand of the auxiliary supply 230 V 1 AC 50/60 Hz ⁴⁾	A	4	4	4	4	4	4
Max. current demand of the auxiliary supply 400 V 3 AC 50/60 Hz ⁵⁾	A	31	31	31	31	31	31
Raw water flow rate	l/min	183	183	183	183	283	283
Deionized water volume	l	100	100	100	100	100	100
Sound pressure level L _{pA} (1m)	dB	76	76	76	76	76	76
Measuring surface level L _s (1m)	dB	19	19	19	19	19	19
Cable cross-sections, line-side, max. connectable per phase ^{6) 7)}	mm ² (DIN VDE)	4 × 240	4 × 240	4 × 240	4 × 240	4 × 240	4 × 240
	AWG/MCM (NEC,CEC)	4 × 500 MCM	4 × 500 MCM	4 × 500 MCM	4 × 500 MCM	4 × 500 MCM	4 × 500 MCM
Cable cross-sections, motor-side, max. connectable per phase ^{6) 7)}	mm ² (DIN VDE)	3 × 240	3 × 240	3 × 240	3 × 240	3 × 240	3 × 240
	AWG/MCM (NEC,CEC)	3 × 500 MCM	3 × 500 MCM	3 × 500 MCM	3 × 500 MCM	3 × 500 MCM	3 × 500 MCM
PE connection, max. cross-section at the enclosure with M12 screw ⁶⁾	mm ² (DIN VDE)	4 × 240	4 × 240	4 × 240	4 × 240	4 × 240	4 × 240
	AWG/MCM (NEC,CEC)	4 × 500 MCM	4 × 500 MCM	4 × 500 MCM	4 × 500 MCM	4 × 500 MCM	4 × 500 MCM
Degree of protection	–	IP43	IP43	IP43	IP43	IP43	IP43
Dimensions ⁸⁾	Width	mm	5420	5420	5420	5420	5420
	Height	mm	2280	2280	2280	2280	2280
	Depth	mm	1275	1275	1275	1275	1275
Circuit version	Fig. No.	3	3	3	3	3	3
Weight ⁸⁾	kg	4000	4000	4000	4000	4200	4200

1) The data for the rated input current and the power data in hp and kW are approximate values only; these have been calculated for operation with induction motors and for a typical motor power factor cos φ and motor efficiency, which are obtained by selecting the following values: Motor power factor between 0.85 and 0.88 and a motor efficiency of 96 %. The rated input current also depends on the line power factor, for which a typical value of between 0.94 and 0.96 was assumed. The hp data are based on the NEC and CEC guidelines for the North American market. The kW values are specified in multiples of 50. Both approximate values need to be adapted to the motor which is actually used.

2) Approx. 5% of the power loss is dissipated to the room.

3) Without cooling system

4) The typical current drawn (rms value; cosφ_{typ} = 0.6) of the supply for the converter open-loop/closed-loop control is specified. The separate supplies for the socket outlets/light or switched auxiliary power feeders (options N35 to N38) have not been taken into account.

Values for the typical current drawn for special configurations (e.g. for dimensioning an upstream UPS) are available on request.

When using options L48 (make-proof grounding switch at the converter input), L49 (make-proof grounding switch at the converter output) or L51 (disconnecter at the converter output), it should further be taken into account that for switching operations, additional peak values of up to 10 A can occur for each make-proof grounding switch or disconnecter. This corresponds to the starting current of a motor used to operate a switch, which decays from approx. 10 A to approx. 2 A in 200 ms. A switching operation takes a total time of approx. 2 s. All optionally used make-proof grounding switches or disconnecters are controlled via the manually actuated make-proof grounding switch for the converter DC link (standard) and therefore switch simultaneously!

5) Additional 20 A precharging current for 25 s.

6) Data refer to a sub-system; for details about the number of sub-systems to be connected on the line or motor side, see circuit versions.

7) The maximum permissible cable lengths should be carefully observed (see power cables 11.7).

8) The specified dimensions and weights include doors, panels and cooling unit, however no options.

SINAMICS GM150 in the IGBT version Water cooling		Article number: 6SL3815-...					
		...2LN41-1AB3	...2LN41-2AB3	...2LN41-3AB3	...2LN41-4AB3	...2LN41-6AB3	...2LN41-8AB3
Output voltage 3.3 kV							
Type rating	kVA	3150	3400	3700	4000	4550	5150
Shaft output ¹⁾	kW	2650	2800	3100	3350	3800	4300
	hp	3500	3700	4000	4500	5100	5750
Rated output current	A	2 × 550	2 × 600	2 × 650	2 × 700	2 × 800	2 × 900
Input voltage	kV	2 × (2 × 1.7)	2 × (2 × 1.7)	2 × (2 × 1.7)	2 × (2 × 1.7)	2 × (2 × 1.7)	2 × (2 × 1.7)
Rated input current ¹⁾	A	2 × (2 × 492)	2 × (2 × 536)	2 × (2 × 578)	2 × (2 × 625)	2 × (2 × 671)	2 × (2 × 784)
Power loss ^{2) 3)}	kW	68	75	83	90	104	117
Efficiency ³⁾	%	98.7	98.7	98.7	98.7	98.7	98.7
Typical current demand of the auxiliary supply 230 V 1 AC 50/60 Hz ⁴⁾	A	4	4	4	4	4	4
Max. current demand of the auxiliary supply 400 V 3 AC 50/60 Hz ⁵⁾	A	31	31	31	31	31	31
Raw water flow rate	l/min	283	283	283	283	283	283
Deionized water volume	l	100	100	100	100	100	100
Sound pressure level L _{PA} (1m)	dB	76	76	76	76	76	76
Measuring surface level L _s (1m)	dB	19	19	19	19	19	19
Cable cross-sections, line-side, max. connectable per phase ^{6) 7)}	mm ² (DIN VDE)	4 × 240	4 × 240	4 × 240	4 × 240	4 × 240	4 × 240
	AWG/MCM (NEC,CEC)	4 × 500 MCM	4 × 500 MCM	4 × 500 MCM	4 × 500 MCM	4 × 500 MCM	4 × 500 MCM
Cable cross-sections, motor-side, max. connectable per phase ^{6) 7)}	mm ² (DIN VDE)	3 × 240	3 × 240	3 × 240	3 × 240	3 × 240	3 × 240
	AWG/MCM (NEC,CEC)	3 × 500 MCM	3 × 500 MCM	3 × 500 MCM	3 × 500 MCM	3 × 500 MCM	3 × 500 MCM
PE connection, max. cross-section at the enclosure with M12 screw ⁶⁾	mm ² (DIN VDE)	4 × 240	4 × 240	4 × 240	4 × 240	4 × 240	4 × 240
	AWG/MCM (NEC,CEC)	4 × 500 MCM	4 × 500 MCM	4 × 500 MCM	4 × 500 MCM	4 × 500 MCM	4 × 500 MCM
Degree of protection	–	IP43	IP43	IP43	IP43	IP43	IP43
Dimensions ⁸⁾	Width	mm	5420	5420	5420	5420	5420
	Height	mm	2280	2280	2280	2280	2280
	Depth	mm	1275	1275	1275	1275	1275
Circuit version	Fig. No.	3	3	3	3	3	3
Weight ⁸⁾	kg	4000	4000	4000	4000	4200	4200

1) The data for the rated input current and the power data in hp and kW are approximate values only; these have been calculated for operation with induction motors and for a typical motor power factor $\cos \varphi$ and motor efficiency, which are obtained by selecting the following values: Motor power factor between 0.85 and 0.88 and a motor efficiency of 96 %. The rated input current also depends on the line power factor, for which a typical value of between 0.94 and 0.96 was assumed. The hp data are based on the NEC and CEC guidelines for the North American market. The kW values are specified in multiples of 50. Both approximate values need to be adapted to the motor which is actually used.

2) Approx. 5% of the power loss is dissipated to the room.

3) Without cooling system

4) The typical current drawn (rms value; $\cos \varphi_{typ.} = 0.6$) of the supply for the converter open-loop/closed-loop control is specified. The separate supplies for the socket outlets/light or switched auxiliary power feeders (options N35 to N38) have not been taken into account.

Values for the typical current drawn for special configurations (e.g. for dimensioning an upstream UPS) are available on request. When using options L48 (make-proof grounding switch at the converter input), L49 (make-proof grounding switch at the converter output) or L51 (disconnecter at the converter output), it should further be taken into account that for switching operations, additional peak values of up to 10 A can occur for each make-proof grounding switch or disconnecter. This corresponds to the starting current of a motor used to operate a switch, which decays from approx. 10 A to approx. 2 A in 200 ms. A switching operation takes a total time of approx. 2 s. All optionally used make-proof grounding switches or disconnecters are controlled via the manually actuated make-proof grounding switch for the converter DC link (standard) and therefore switch simultaneously!

5) Additional 20 A precharging current for 25 s.

6) Data refer to a sub-system; for details about the number of sub-systems to be connected on the line or motor side, see circuit versions.

7) The maximum permissible cable lengths should be carefully observed (see power cables 11.7).

8) The specified dimensions and weights include doors, panels and cooling unit, however no options.

SINAMICS GM150 in the IGBT version Water cooling		Article number: 6SL3815-...					
		...2LP32-8AA3	...2LP33-1AA3	...2LP33-5AA3	...2LP34-0AA3	...2LP34-5AA3	...2LP35-0AA3
Output voltage 4.16 kV							
Type rating	kVA	2000	2200	2500	2900	3200	3600
Shaft output ¹⁾	kW	1700	1850	2100	2400	2700	3000
	hp	2250	2500	2750	3000	3500	4000
Rated output current	A	280	310	350	400	450	500
Input voltage	kV	2 × 2.2	2 × 2.2	2 × 2.2	2 × 2.2	2 × 2.2	2 × 2.2
Rated input current ¹⁾	A	2 × 240	2 × 265	2 × 299	2 × 342	2 × 385	2 × 428
Power loss ^{2) 3)}	kW	22	23	26	29	31	34
Efficiency ³⁾	%	98.7	98.8	98.8	98.8	98.9	98.9
Typical current demand of the auxiliary supply 230 V 1 AC 50/60 Hz ⁴⁾	A	2.5	2.5	2.5	2.5	2.5	2.5
Max. current demand of the auxiliary supply 400 V 3 AC 50/60 Hz ⁵⁾	A	14	14	14	14	14	14
Raw water flow rate	l/min	117	117	117	117	117	117
Deionized water volume	l	90	90	90	90	90	90
Sound pressure level L _{pA} (1m)	dB	73	73	73	73	73	73
Measuring surface level L _s (1m)	dB	18	18	18	18	18	18
Cable cross-sections, line-side, max. connectable per phase ^{6) 7)}	mm ² (DIN VDE)	4 × 240	4 × 240	4 × 240	4 × 240	4 × 240	4 × 240
	AWG/MCM (NEC,CEC)	4 × 500 MCM	4 × 500 MCM	4 × 500 MCM	4 × 500 MCM	4 × 500 MCM	4 × 500 MCM
Cable cross-sections, motor-side, max. connectable per phase ^{6) 7)}	mm ² (DIN VDE)	3 × 240	3 × 240	3 × 240	3 × 240	3 × 240	3 × 240
	AWG/MCM (NEC,CEC)	3 × 500 MCM	3 × 500 MCM	3 × 500 MCM	3 × 500 MCM	3 × 500 MCM	3 × 500 MCM
PE connection, max. cross-section at the enclosure with M12 screw ⁶⁾	mm ² (DIN VDE)	4 × 240	4 × 240	4 × 240	4 × 240	4 × 240	4 × 240
	AWG/MCM (NEC,CEC)	4 × 500 MCM	4 × 500 MCM	4 × 500 MCM	4 × 500 MCM	4 × 500 MCM	4 × 500 MCM
Degree of protection	–	IP43	IP43	IP43	IP43	IP43	IP43
Dimensions ⁸⁾	Width	mm	3620	3620	3620	3620	3620
	Height	mm	2280	2280	2280	2280	2280
	Depth	mm	1275	1275	1275	1275	1275
Circuit version	Fig. No.	1	1	1	1	1	1
Weight ⁸⁾	kg	2650	2700	2700	2700	2750	2750

1) The data for the rated input current and the power data in hp and kW are approximate values only; these have been calculated for operation with induction motors and for a typical motor power factor cos φ and motor efficiency, which are obtained by selecting the following values: Motor power factor between 0.85 and 0.88 and a motor efficiency of 96 %. The rated input current also depends on the line power factor, for which a typical value of between 0.94 and 0.96 was assumed. The hp data are based on the NEC and CEC guidelines for the North American market. The kW values are specified in multiples of 50. Both approximate values need to be adapted to the motor which is actually used.

2) Approx. 5% of the power loss is dissipated to the room.

3) Without cooling system

4) The typical current drawn (rms value; cosφ_{typ} = 0.6) of the supply for the converter open-loop/closed-loop control is specified. The separate supplies for the socket outlets/light or switched auxiliary power feeders (options N35 to N38) have not been taken into account.

Values for the typical current drawn for special configurations (e.g. for dimensioning an upstream UPS) are available on request. When using options L48 (make-proof grounding switch at the converter input), L49 (make-proof grounding switch at the converter output) or L51 (disconnector at the converter output), it should further be taken into account that for switching operations, additional peak values of up to 10 A can occur for each make-proof grounding switch or disconnector. This corresponds to the starting current of a motor used to operate a switch, which decays from approx. 10 A to approx. 2 A in 200 ms. A switching operation takes a total time of approx. 2 s. All optionally used make-proof grounding switches or disconnectors are controlled via the manually actuated make-proof grounding switch for the converter DC link (standard) and therefore switch simultaneously!

5) Additional 20 A precharging current for 25 s.

6) Data refer to a sub-system; for details about the number of sub-systems to be connected on the line or motor side, see circuit versions.

7) The maximum permissible cable lengths should be carefully observed (see power cables 11.7).

8) The specified dimensions and weights include doors, panels and cooling unit, however no options.

2.6 Technical specifications

SINAMICS GM150 in the IGBT version Water cooling		Article number: 6SL3815-...						
		2LP35-5AA3	2LP36-0AA3	2LP36-6AA3	2LP37-4AA3	2LP38-0AA3	2LP38-8AA3	2LP41-0AA3
Output voltage 4.16 kV								
Type rating	kVA	4000	4300	4800	5300	5800	6400	7200
Shaft output ¹⁾	kW	3300	3600	4000	4500	4800	5300	5900
	hp	4500	4850	5450	6000	6500	7150	8000
Rated output current	A	550	600	660	740	800	880	1000
Input voltage	kV	2 × 2.2	2 × 2.2	2 × 2.2	2 × 2.2	2 × 2.2	2 × 2.2	2 × 2.2
Rated input current ¹⁾	A	2 × 479	2 × 514	2 × 564	2 × 632	2 × 684	2 × 772	2 × 870
Power loss ^{2) 3)}	kW	38	41	44	47	51	65	74
Efficiency ³⁾	%	98.9	98.9	98.9	99.0	99.0	98.8	98.8
Typical current demand of the auxiliary supply 230 V 1 AC 50/60 Hz ⁴⁾	A	2.5	2.5	2.5	2.5	2.5	2.5	2.5
Max. current demand of the auxiliary supply 400 V 3 AC 50/60 Hz ⁵⁾	A	14	14	14	14	14	25	25
Raw water flow rate	l/min	117	117	117	117	117	183	183
Deionized water volume	l	90	90	90	90	90	90	90
Sound pressure level L _{pA} (1m)	dB	73	73	73	73	73	73	73
Measuring surface level L _s (1m)	dB	18	18	18	18	18	18	18
Cable cross-sections, line-side, max. connectable per phase ^{6) 7)}	mm ² (DIN VDE)	4 × 240	4 × 240	4 × 240	4 × 240	4 × 240	4 × 240	4 × 240
	AWG/MCM (NEC, CEC)	4 × 500 MCM	4 × 500 MCM	4 × 500 MCM	4 × 500 MCM	4 × 500 MCM	4 × 500 MCM	4 × 500 MCM
Cable cross-sections, motor-side, max. connectable per phase ^{6) 7)}	mm ² (DIN VDE)	3 × 240	3 × 240	3 × 240	3 × 240	3 × 240	3 × 240	3 × 240
	AWG/MCM (NEC, CEC)	3 × 500 MCM	3 × 500 MCM	3 × 500 MCM	3 × 500 MCM	3 × 500 MCM	3 × 500 MCM	3 × 500 MCM
PE connection, max. cross-section at the enclosure with M12 screw ⁶⁾	mm ² (DIN VDE)	4 × 240	4 × 240	4 × 240	4 × 240	4 × 240	4 × 240	4 × 240
	AWG/MCM (NEC, CEC)	4 × 500 MCM	4 × 500 MCM	4 × 500 MCM	4 × 500 MCM	4 × 500 MCM	4 × 500 MCM	4 × 500 MCM
Degree of protection	–	IP43	IP43	IP43	IP43	IP43	IP43	IP43
Dimensions ⁸⁾	Width	mm	3620	3620	3620	3620	3620	3620
	Height	mm	2280	2280	2280	2280	2280	2280
	Depth	mm	1275	1275	1275	1275	1275	1275
Circuit version	Fig. No.	1	1	1	1	1	1	1
Weight ⁸⁾	kg	2750	2750	2750	2750	2750	2850	2850

1) The data for the rated input current and the power data in hp and kW are approximate values only; these have been calculated for operation with induction motors and for a typical motor power factor $\cos \varphi$ and motor efficiency, which are obtained by selecting the following values: Motor power factor between 0.85 and 0.88 and a motor efficiency of 96 %. The rated input current also depends on the line power factor, for which a typical value of between 0.94 and 0.96 was assumed. The hp data are based on the NEC and CEC guidelines for the North American market. The kW values are specified in multiples of 50. Both approximate values need to be adapted to the motor which is actually used.

2) Approx. 5% of the power loss is dissipated to the room.

3) Without cooling system

4) The typical current drawn (rms value; $\cos \varphi_{typ.} = 0.6$) of the supply for the converter open-loop/closed-loop control is specified. The separate supplies for the socket outlets/light or switched auxiliary power feeders (options N35 to N38) have not been taken into account.

Values for the typical current drawn for special configurations (e.g. for dimensioning an upstream UPS) are available on request. When using options L48 (make-proof grounding switch at the converter input), L49 (make-proof grounding switch at the converter output) or L51 (disconnecter at the converter output), it should further be taken into account that for switching operations, additional peak values of up to 10 A can occur for each make-proof grounding switch or disconnecter. This corresponds to the starting current of a motor used to operate a switch, which decays from approx. 10 A to approx. 2 A in 200 ms. A switching operation takes a total time of approx. 2 s. All optionally used make-proof grounding switches or disconnecters are controlled via the manually actuated make-proof grounding switch for the converter DC link (standard) and therefore switch simultaneously!

5) Additional 20 A precharging current for 25 s.

6) Data refer to a sub-system; for details about the number of sub-systems to be connected on the line or motor side, see circuit versions.

7) The maximum permissible cable lengths should be carefully observed (see power cables 11.7).

8) The specified dimensions and weights include doors, panels and cooling unit, however no options.

SINAMICS GM150 in the IGBT version Water cooling		Article number: 6SL3815-...					
		...2LP41-1AA3	...2LP41-2AA3	...2LP41-3AA3	...2LP41-4AA3	...2LP41-6AA3	...2LP41-8AA3
Output voltage 4.16 kV							
Type rating	kVA	7900	8600	9400	10100	11500	13000
Shaft output ¹⁾	kW	6600	7150	7900	8500	9600	11250
	hp	9000	9500	10000	11000	13000	15300
Rated output current	A	2 × 550	2 × 600	2 × 650	2 × 700	2 × 800	2 × 900
Input voltage	kV	2 × (2 × 2.2)	2 × (2 × 2.2)	2 × (2 × 2.2)	2 × (2 × 2.2)	2 × (2 × 2.2)	2 × (2 × 2.2)
Rated input current ¹⁾	A	2 × (2 × 471)	2 × (2 × 513)	2 × (2 × 556)	2 × (2 × 598)	2 × (2 × 684)	2 × (2 × 785)
Power loss ^{2) 3)}	kW	76	82	87	92	103	133
Efficiency ³⁾	%	98.9	98.9	98.9	98.9	99.0	98.8
Typical current demand of the auxiliary supply 230 V 1 AC 50/60 Hz ⁴⁾	A	4	4	4	4	4	4
Max. current demand of the auxiliary supply 400 V 3 AC 50/60 Hz ⁵⁾	A	20	20	20	20	20	31
Raw water flow rate	l/min	183	183	183	283	283	283
Deionized water volume	l	100	100	100	100	100	100
Sound pressure level L _{pA} (1m)	dB	76	76	76	76	76	76
Measuring surface level L _s (1m)	dB	19	19	19	19	19	19
Cable cross-sections, line-side, max. connectable per phase ^{6) 7)}	mm ² (DIN VDE)	4 × 240	4 × 240	4 × 240	4 × 240	4 × 240	4 × 240
	AWG/MCM (NEC,CEC)	4 × 500 MCM	4 × 500 MCM	4 × 500 MCM	4 × 500 MCM	4 × 500 MCM	4 × 500 MCM
Cable cross-sections, motor-side, max. connectable per phase ^{6) 7)}	mm ² (DIN VDE)	3 × 240	3 × 240	3 × 240	3 × 240	3 × 240	3 × 240
	AWG/MCM (NEC,CEC)	3 × 500 MCM	3 × 500 MCM	3 × 500 MCM	3 × 500 MCM	3 × 500 MCM	3 × 500 MCM
PE connection, max. cross-section at the enclosure with M12 screw ⁶⁾	mm ² (DIN VDE)	4 × 240	4 × 240	4 × 240	4 × 240	4 × 240	4 × 240
	AWG/MCM (NEC,CEC)	4 × 500 MCM	4 × 500 MCM	4 × 500 MCM	4 × 500 MCM	4 × 500 MCM	4 × 500 MCM
Degree of protection	–	IP43	IP43	IP43	IP43	IP43	IP43
Dimensions ⁸⁾	Width	mm	5420	5420	5420	5420	5420
	Height	mm	2280	2280	2280	2280	2280
	Depth	mm	1275	1275	1275	1275	1275
Circuit version	Fig. No.	3	3	3	3	3	3
Weight ⁸⁾	kg	4000	4000	4000	4000	4000	4200

1) The data for the rated input current and the power data in hp and kW are approximate values only; these have been calculated for operation with induction motors and for a typical motor power factor cos φ and motor efficiency, which are obtained by selecting the following values: Motor power factor between 0.85 and 0.88 and a motor efficiency of 96 %. The rated input current also depends on the line power factor, for which a typical value of between 0.94 and 0.96 was assumed. The hp data are based on the NEC and CEC guidelines for the North American market. The kW values are specified in multiples of 50. Both approximate values need to be adapted to the motor which is actually used.

2) Approx. 5% of the power loss is dissipated to the room.

3) Without cooling system

4) The typical current drawn (rms value; cosφ_{typ.} = 0.6) of the supply for the converter open-loop/closed-loop control is specified. The separate supplies for the socket outlets/light or switched auxiliary power feeders (options N35 to N38) have not been taken into account.

Values for the typical current drawn for special configurations (e.g. for dimensioning an upstream UPS) are available on request. When using options L48 (make-proof grounding switch at the converter input), L49 (make-proof grounding switch at the converter output) or L51 (disconnector at the converter output), it should further be taken into account that for switching operations, additional peak values of up to 10 A can occur for each make-proof grounding switch or disconnector. This corresponds to the starting current of a motor used to operate a switch, which decays from approx. 10 A to approx. 2 A in 200 ms. A switching operation takes a total time of approx. 2 s. All optionally used make-proof grounding switches or disconnectors are controlled via the manually actuated make-proof grounding switch for the converter DC link (standard) and therefore switch simultaneously!

5) Additional 20 A precharging current for 25 s.

6) Data refer to a sub-system; for details about the number of sub-systems to be connected on the line or motor side, see circuit versions.

7) The maximum permissible cable lengths should be carefully observed (see power cables 11.7).

8) The specified dimensions and weights include doors, panels and cooling unit, however no options.

SINAMICS GM150 in the IGBT version Water cooling		Article number: 6SL3815-...					
		...2LP41-1AB3	...2LP41-2AB3	...2LP41-3AB3	...2LP41-4AB3	...2LP41-6AB3	...2LP41-8AB3
Output voltage 4.16 kV							
Type rating	kVA	7900	8600	9400	10100	11500	13000
Shaft output ¹⁾	kW	6600	7150	7900	8500	9600	11250
	hp	9000	9500	10000	11000	13000	15300
Rated output current	A	2 × 550	2 × 600	2 × 650	2 × 700	2 × 800	2 × 900
Input voltage	kV	2 × (2 × 2.2)	2 × (2 × 2.2)	2 × (2 × 2.2)	2 × (2 × 2.2)	2 × (2 × 2.2)	2 × (2 × 2.2)
Rated input current ¹⁾	A	2 × (2 × 471)	2 × (2 × 513)	2 × (2 × 556)	2 × (2 × 598)	2 × (2 × 684)	2 × (2 × 785)
Power loss ^{2) 3)}	kW	76	82	87	92	103	133
Efficiency ³⁾	%	98.9	98.9	98.9	98.9	99.0	98.8
Typical current demand of the auxiliary supply 230 V 1 AC 50/60 Hz ⁴⁾	A	4	4	4	4	4	4
Max. current demand of the auxiliary supply 400 V 3 AC 50/60 Hz ⁵⁾	A	20	20	20	20	20	31
Raw water flow rate	l/min	283	283	283	283	283	283
Deionized water volume	l	100	100	100	100	100	100
Sound pressure level L _{pA} (1m)	dB	76	76	76	76	76	76
Measuring surface level L _s (1m)	dB	19	19	19	19	19	19
Cable cross-sections, line-side, max. connectable per phase ^{6) 7)}	mm ² (DIN VDE)	4 × 240	4 × 240	4 × 240	4 × 240	4 × 240	4 × 240
	AWG/MCM (NEC,CEC)	4 × 500 MCM	4 × 500 MCM	4 × 500 MCM	4 × 500 MCM	4 × 500 MCM	4 × 500 MCM
Cable cross-sections, motor-side, max. connectable per phase ^{6) 7)}	mm ² (DIN VDE)	3 × 240	3 × 240	3 × 240	3 × 240	3 × 240	3 × 240
	AWG/MCM (NEC,CEC)	3 × 500 MCM	3 × 500 MCM	3 × 500 MCM	3 × 500 MCM	3 × 500 MCM	3 × 500 MCM
PE connection, max. cross-section at the enclosure with M12 screw ⁶⁾	mm ² (DIN VDE)	4 × 240	4 × 240	4 × 240	4 × 240	4 × 240	4 × 240
	AWG/MCM (NEC,CEC)	4 × 500 MCM	4 × 500 MCM	4 × 500 MCM	4 × 500 MCM	4 × 500 MCM	4 × 500 MCM
Degree of protection	–	IP43	IP43	IP43	IP43	IP43	IP43
Dimensions ⁸⁾	Width	mm	5420	5420	5420	5420	5420
	Height	mm	2280	2280	2280	2280	2280
	Depth	mm	1275	1275	1275	1275	1275
Circuit version	Fig. No.	3	3	3	3	3	3
Weight ⁸⁾	kg	4000	4000	4000	4000	4000	4200

1) The data for the rated input current and the power data in hp and kW are approximate values only; these have been calculated for operation with induction motors and for a typical motor power factor $\cos \varphi$ and motor efficiency, which are obtained by selecting the following values: Motor power factor between 0.85 and 0.88 and a motor efficiency of 96 %. The rated input current also depends on the line power factor, for which a typical value of between 0.94 and 0.96 was assumed. The hp data are based on the NEC and CEC guidelines for the North American market. The kW values are specified in multiples of 50. Both approximate values need to be adapted to the motor which is actually used.

2) Approx. 5% of the power loss is dissipated to the room.

3) Without cooling system

4) The typical current drawn (rms value; $\cos \varphi_{typ} = 0.6$) of the supply for the converter open-loop/closed-loop control is specified. The separate supplies for the socket outlets/light or switched auxiliary power feeders (options N35 to N38) have not been taken into account.

Values for the typical current drawn for special configurations (e.g. for dimensioning an upstream UPS) are available on request. When using options L48 (make-proof grounding switch at the converter input), L49 (make-proof grounding switch at the converter output) or L51 (disconnector at the converter output), it should further be taken into account that for switching operations, additional peak values of up to 10 A can occur for each make-proof grounding switch or disconnector. This corresponds to the starting current of a motor used to operate a switch, which decays from approx. 10 A to approx. 2 A in 200 ms. A switching operation takes a total time of approx. 2 s. All optionally used make-proof grounding switches or disconnectors are controlled via the manually actuated make-proof grounding switch for the converter DC link (standard) and therefore switch simultaneously!

5) Additional 20 A precharging current for 25 s.

6) Data refer to a sub-system; for details about the number of sub-systems to be connected on the line or motor side, see circuit versions.

7) The maximum permissible cable lengths should be carefully observed (see power cables 11.7).

8) The specified dimensions and weights include doors, panels and cooling unit, however no options.

3 SINAMICS GM150 IGCT version

3.1 Overview



Fig. 3-1 SINAMICS GM150 in the IGCT version

The water-cooled SINAMICS GM150 converters in the IGCT version with IGCT Motor Modules represent an expansion of the SINAMICS GM150 converters in the IGBT version in the upper power range up to 21 MVA.

SINAMICS GM150 converters in the IGCT version are optimally matched to Siemens motors.

SINAMICS GM150 converters in the IGCT version offer economic drive solutions that can be matched to customers' specific requirements by adding from the wide range of available components and options.

IGCT converters are available for the following voltage and outputs:

Rated output voltage	Type rating
3.3 kV	10 MVA to 21 MVA ¹⁾

1) Higher power ratings on request (e.g. "Tandem configuration")

Global use

SINAMICS GM150 converters in the IGCT version are manufactured to international standards and regulations, making them ideally suited for global use. These converters are also available in ship-going form (meeting the requirements of all major classification organizations).

3.2 Benefits

- Compact design and highly flexible configuration ensures easy plant integration
- Simple operator control and monitoring from the user-friendly operator panel
- Simple and reliable operation through integrated maintenance functions: The converter signals early on and automatically if maintenance is required or components need to be replaced
- High degree of ruggedness and reliability due to the use of IGCT power semiconductors in the high power range and fuseless design combined with an intelligent response to external disturbances
- Can be easily integrated into automation solutions as the PROFINET interface is supplied as standard along with various analog and digital interfaces
- High level of service-friendliness through innovative power section design with compact phase modules and easy access to all components

3.3 Design

SINAMICS GM150 converters in the IGCT version are available in the basic circuit configuration with a 12-pulse or 24-pulse Basic Line Module (option).

For higher output power ratings, two or three complete converter units with isolated DC links are operated in parallel.

Phase components in which IGCTs, diodes etc. are grouped together in one pressure stack are used in the Motor Modules.

The converter consists of cabinet units for the Basic Line Module and for the Motor Module. One of three phase components and the control section in the Motor Module cabinet unit are highlighted in the illustration.

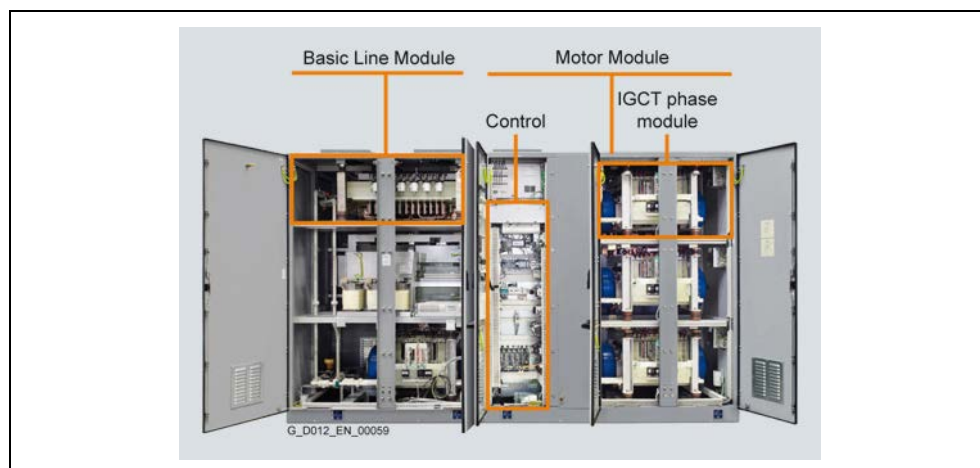

Fig. 3-2 SINAMICS GM150 in the IGCT version, internal design (without cooling unit)

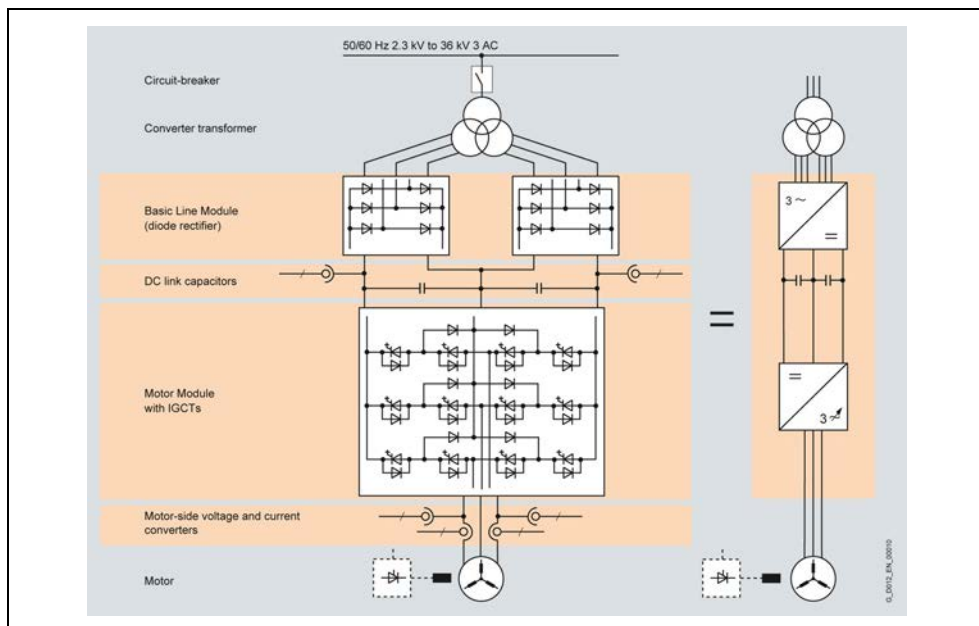

Fig. 3-3 Block diagram

The following circuit versions are available for SINAMICS GM150 in the IGCT version.

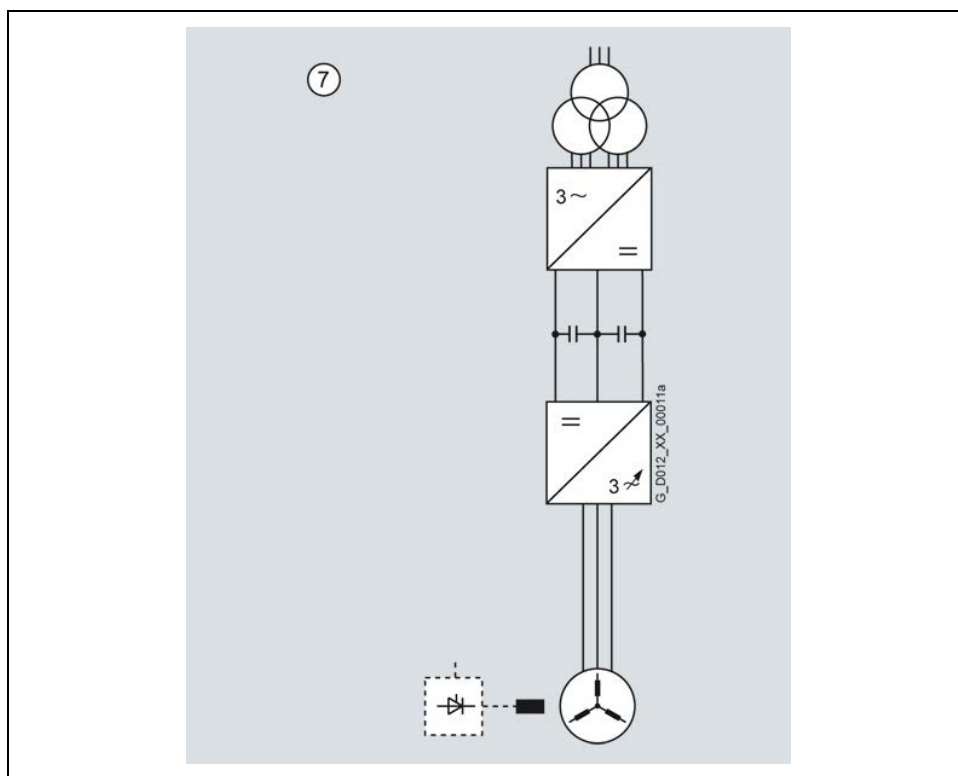

Fig. 3-4 Basic circuit, 12-pulse infeed

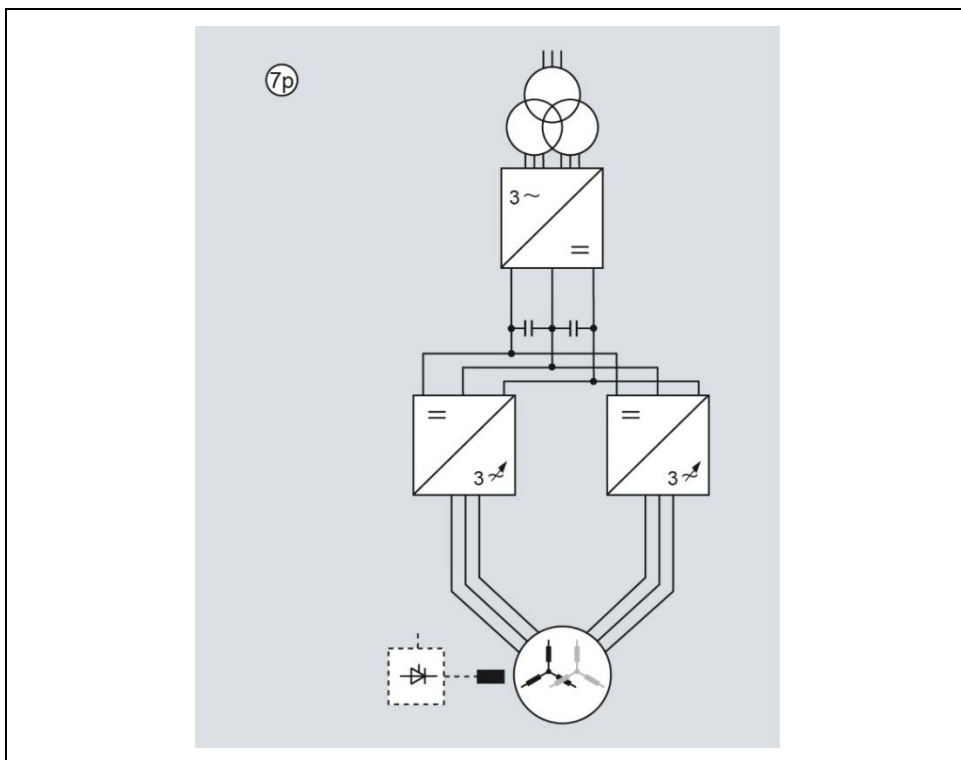

Fig. 3-5 Parallel circuit, 12-pulse infeed

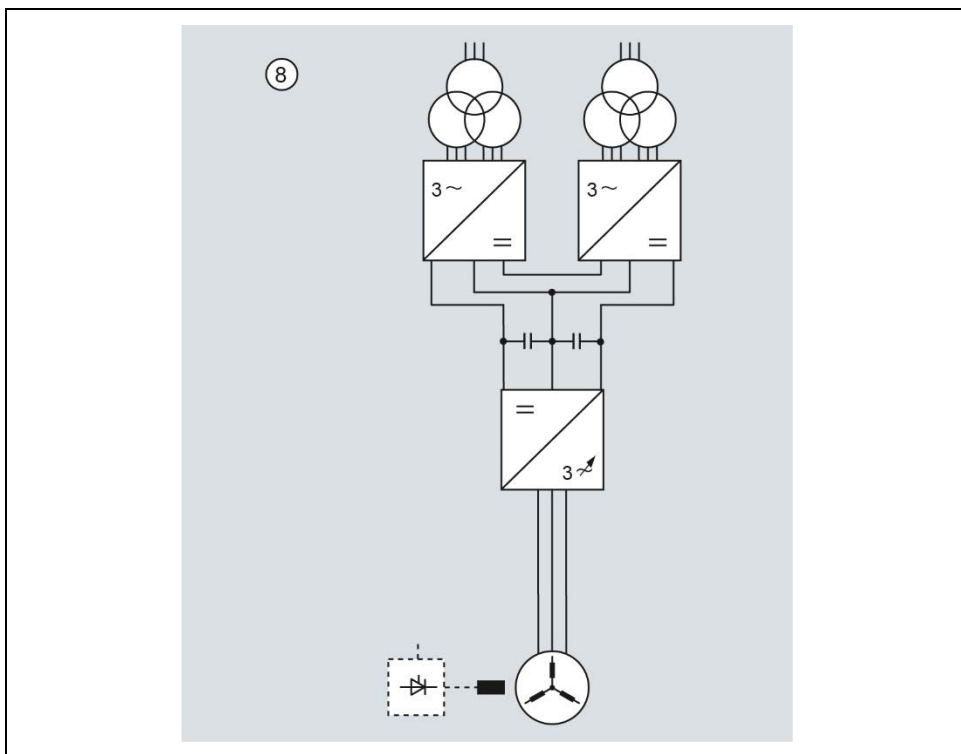

Fig. 3-6 24-pulse infeed by connecting two Basic Line Modules in series: Option N15

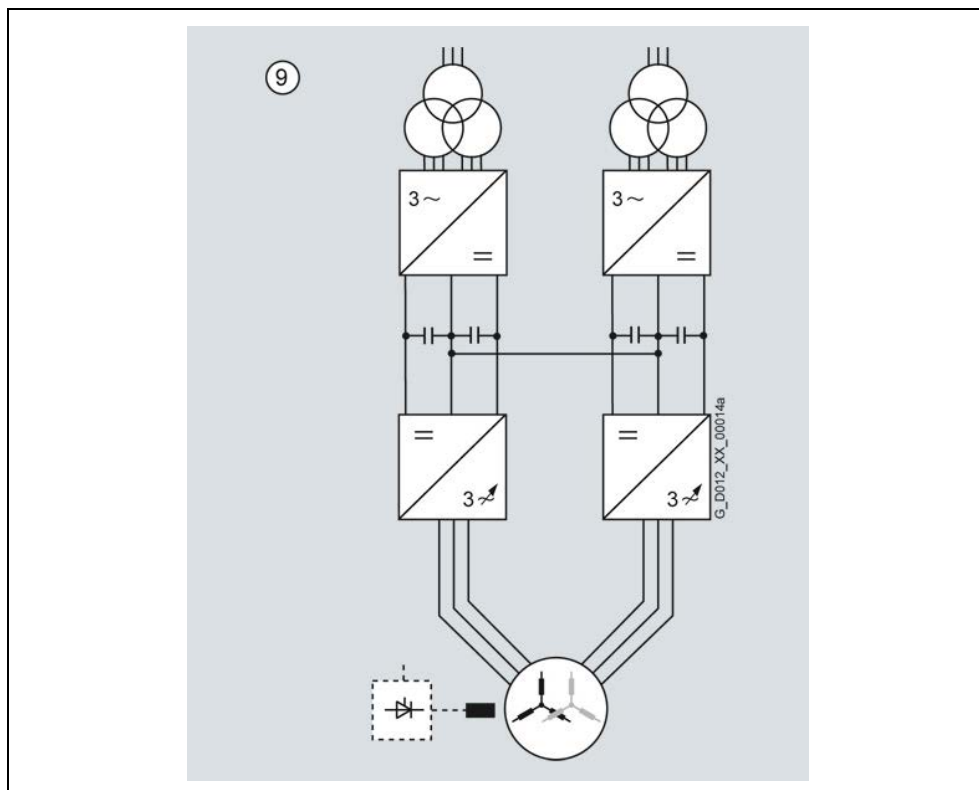

Fig. 3-7 Increased power rating by connecting two converter units in parallel ¹⁾, 24-pulse infeed

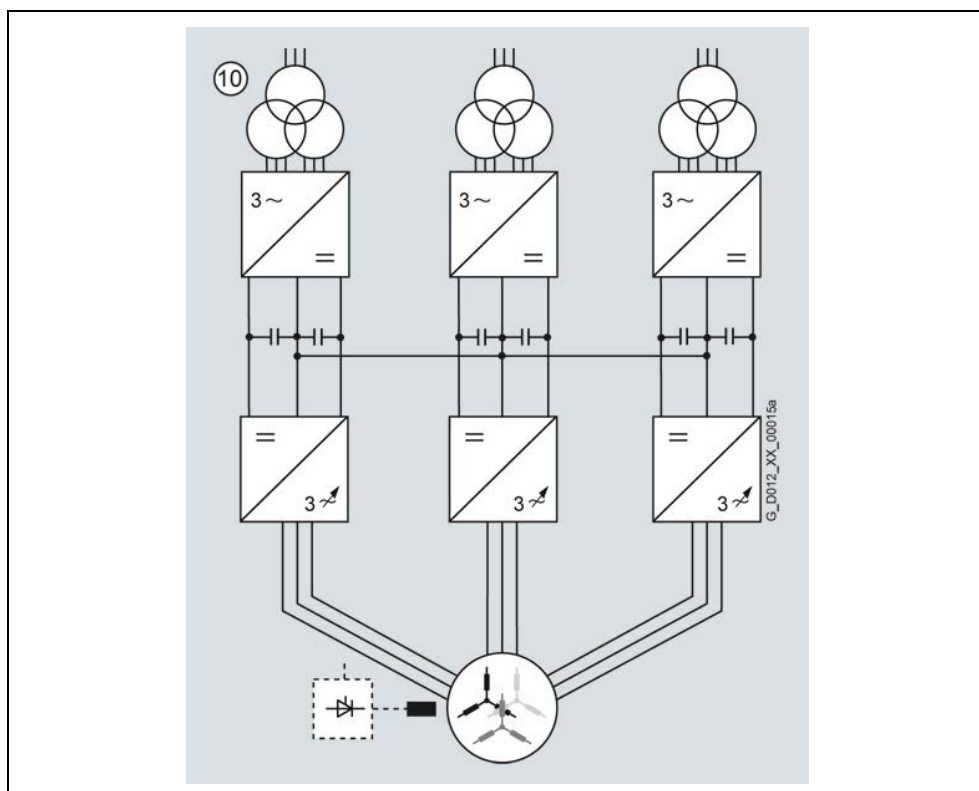

Fig. 3-8 Increased power rating by connecting three converter units in parallel ¹⁾, 36-pulse infeed

1) Requires a motor with separate winding systems.

3.4 Function

Characteristic features

SINAMICS GM150 in the IGCT version		
Line Module (line-side rectifier)		
Basic Line Module, 12-pulse (two-quadrant operation)	Standard	
Basic Line Module, 24-pulse (two-quadrant operation)	Option Standard for a parallel circuit configuration	
Basic Line Module, 36-pulse (two-quadrant operation)	Standard for a triple parallel circuit configuration	
Motor Module (motor-side inverter)		
Voltage range	3.3 kV	
Power range (typ.)	10 ... 21 MVA	
Cooling method • Water cooling	Standard	
Control modes • Induction motor • Synchronous motor, separately excited with slipring excitation • Synchronous motor, separately excited with brushless rotating reverse-field excitation • Synchronous motor, permanently excited	<u>Without encoder</u> Standard On request On request On request	<u>With encoder</u> Standard Option On request Option

Software and protection functions

SINAMICS GM150 in the IGCT version	Description
Closed-loop control	<p>The motor-side closed-loop control is realized as a field-oriented closed-loop vector control that can be operated as a speed or torque control as required. The closed-loop vector control achieves the dynamic performance of a DC drive. This is made possible by the fact that the current components forming the torque and flux can be controlled precisely independently of each other. Prescribed torques can thus be observed and limited accurately. In the speed range from 1:10, the field-oriented closed-loop control does not require an actual speed value encoder.</p> <p>An actual speed value encoder is required in the following scenarios:</p> <ul style="list-style-type: none"> • High dynamics requirements • Torque control/constant torque drives with a control range > 1:10 • Very low speeds • Very high speed accuracy
Setpoint input	<p>The setpoint can be defined internally or externally; internally as a fixed setpoint, motorized potentiometer setpoint or jog setpoint, externally via the PROFINET interface or an analog input of the customer terminal block. The internal fixed setpoint and the motorized potentiometer setpoint can be switched over or adjusted using control commands via all of the interfaces.</p>
Ramp-function generator	<p>A user-friendly ramp-function generator with separately adjustable ramp-up and ramp-down times, together with variable smoothing times in the lower and upper speed ranges, improves the control response and therefore prevents mechanical overloading of the drive train. The ramp-down ramps can be parameterized separately for emergency stop.</p>

SINAMICS GM150 in the IGCT version	Description
V_{dc max} controller	The V _{dc max} controller automatically prevents overvoltages in the DC link, if the set down ramp is too short, for example. This can also extend the set ramp-down time.
Kinetic buffering	Power supply failures are bridged to the extent permitted by the kinetic energy of the drive train. The speed drops depending on the moment of inertia and the load torque. The current speed setpoint is resumed when the power supply returns. This function can result in fast load changes, which can have a negative impact on the line supply (especially for weak line supplies, as is the case on board a ship). Kinetic buffering is not available when operating separately excited synchronous motors.
Automatic restart (option L32)	The automatic restart switches the drive on again when the power is restored after a power failure or a general fault, and ramps up to the actual speed setpoint.
Flying restart	The flying restart function permits smooth connection of the converter to a rotating motor.
Diagnostic functions	<ul style="list-style-type: none"> • Self-diagnosis of control hardware • Non-volatile memory for reliable diagnosis when the power supply fails • Monitoring the IGBTs with individual messages for each mounting location • User-friendly on-site operator panel with plain text messages
Operating hours and switching cycles counter	The switching cycles of the circuit breakers are detected and summed to create the basis for preventive maintenance work.
Sensing the actual motor speed (option K50)	The Sensor Module SMC30 can be used to sense the actual motor speed. The signals from the rotary pulse encoder are converted here and made available to the closed-loop control for evaluation via the DRIVE-CLiQ interface.
Operator protection	The cabinet doors of the power sections are fitted with electromagnetic locks. This prevents the cabinet doors being opened while hazardous voltages are connected inside the cabinet.
EMERGENCY OFF button	The converters are equipped as standard with an EMERGENCY OFF button with protective collar which is fitted in the cabinet door. The contacts of the button are connected in parallel to the terminal block so they can be integrated in a protection concept on the plant side. EMERGENCY OFF stop category 0 is set as standard for an uncontrolled shutdown (IEC 60204-1). The function includes voltage disconnection of the converter output through the circuit breaker. The motor coasts in the process. (The auxiliary power circuits are <i>not</i> disconnected.) Optionally available: <ul style="list-style-type: none"> • EMERGENCY STOP Category 1 for a controlled shutdown (option L60) • Control of the "Safe Torque Off" function (option K80)
Insulation monitoring	The converters feature insulation monitoring of the complete electrical circuit from the secondary side of the transformer to the stator windings of the motor.
Monitoring the peripherals	An extensive package of options for I/O monitoring (from the transformer and the motor through to the auxiliaries) is available. In addition it is possible to monitor the temperature with thermocouples or Pt100 resistors.

3.4 Function

SINAMICS GM150 in the IGCT version	Description
Thermal overload protection	<p>An alarm message is issued first when the overtemperature threshold is reached. If the temperature rises further, either a shutdown is carried out or automatic influencing of the output current so that a reduction in the thermal load is achieved. Following elimination of the cause of the fault (e.g. improvement in the ventilation), the original operating values are automatically resumed.</p> <p>In the case of water-cooled converters, the water temperature and flow rate are recorded at several points in the cooling circuit and evaluated. An extensive self-diagnosis protects the converter and reports faults.</p>
Make-proof grounding switch (options L48, L49)	<p>If grounding on the infeed or motor side is required for safety and protection reasons, a motorized make-proof grounding switch can be ordered.</p> <p>For safety reasons, the converter controller locks these make-proof grounding switches against activation while voltage is still present. The control is integrated into the protection and monitoring chain of the converter. The make-proof grounding switches are inserted automatically when the standard make-proof grounding switches of the DC link are inserted.</p>

AOP30 operator panel

Fig. 3-9 AOP30 operator panel

The AOP30 operator panel is fitted into the cabinet door of the SINAMICS GM150 to enable operation, monitoring and commissioning.

It has the following features and characteristics:

- Graphical LCD display with backlighting for plain-text display and a bar display of process variables
- LEDs for displaying the operational status
- Help function describing causes of and remedies for faults and alarms
- Membrane keyboard with keypad for operational control of a drive
- Local/remote switchover to select the operator control location (priority assigned to operator panel or customer terminal block/PROFINET)
- Numeric keypad for input of setpoint or parameter values
- Function keys for prompted navigation in the menu
- Two-stage safety strategy to protect against accidental or unauthorized changes to settings. The keyboard lock disables operation of the drive from the operator panel, so that only parameter values and process variables can be displayed. A password can be used to prevent the unauthorized modification of converter parameters.

Many operator panel languages are saved on the CompactFlash card of the Control Unit (e.g. English, German, Spanish, Chinese).

3.5 Engineering

Standard dimensioning

If the motor data are not precisely known, then the converter should be dimensioned based on the rated output current for typical induction motors. If current derating is required, then the derating factors are applied to this rated output current. The current derating when converter units are operated in parallel has already been taken into account for the values in the selection and ordering data table.

Higher output currents are also possible under certain conditions; refer to the following section.

Detailed dimensioning

If the motor data are more precisely known, then the converters can also be operated with higher output currents. In this case, the rated motor current must lie below the maximum thermal converter output current, and the motor short-circuit current must be less than the maximum permissible motor short-circuit current of the converter.

Note:

The motor short-circuit current is the current that flows in a system in the first 100 ms if all subsystems are short-circuited and the leakage paths are saturated.

For higher rated output currents, the type-specific technical data can differ. Please contact your Siemens sales partner if you have any questions on this topic.

During the detailed dimensioning phase, derating factors should be applied to the maximum thermal converter output current. The current derating when converter units are operated in parallel has already been taken into account for the values in the selection and ordering data table.

3.6 Selection and ordering data

Type rating ¹⁾	Shaft output ¹⁾		Rated output current for typ. induction motors	Max. thermal output current	Max. motor short-circuit current for induction motors	SINAMICS GM150 in the IGCT version	Circuit version
kVA	kW	hp	A	A	A	Article No.	Fig. No.
Output voltage 3.3 kV							
10000	8000	11000	1750	1750	8700	6SL3835-2LN41-8AA3	7
12000 ²⁾	9850 ²⁾	13200 ¹⁾	2100	2100	8700	6SL3835-2LN42-1AA3	7
15500	13000	17000	2 x 1360	2 x 1380	6900	6SL3835-2LN42-3AA3	7p
15500	13000	17000	2 x 1360	2 x 1440	7200	6SL3835-2LN42-8AA3	9
18000	15000	20000	2 x 1570	2 x 1660	8300	6SL3835-2LN43-6AA3	9
21000	17000	23000	3 x 1220	3 x 1630	8100	6SL3835-2LN44-2AA3	10

1) Higher power ratings on request (e.g. "Tandem configuration")

2) Full power at line undervoltage condition on request

3.7 Technical specifications

3.7.1 General technical data

General technical data	
Power components	Diodes, IGCTs
Line-side converter <ul style="list-style-type: none"> • Standard • Option 	Basic Line Module: 12-pulse diode rectifier 24-pulse diode rectifier
Motor-side converter	Motor Module: Inverter
Closed-loop control	Vector control
Drive quadrants	2 (driving 2 directions of rotation)
Electrically isolated power section/open-loop and closed-loop control	Fiber optic cable, isolating transformer
Auxiliary power supply (for fans, coolant pumps, precharging the DC link capacitors, open-loop and closed-loop control)	230 V 1 AC ±10 %, 50/60 Hz ±3 % and 400 V 3 AC ±10 %, 50/60 Hz ±3 % or another auxiliary voltage (options C30 to C55)
Installation altitude	≤ 1000 m above sea level: 100 % load capability > 1000 ... 4000 m above sea level: current derating required > 2000 ... 4000 m above sea level: voltage derating required in addition
Insulation	According to IEC 61800-5-1: Pollution degree 2 (without conductive pollution), condensation not permissible
Degree of protection <ul style="list-style-type: none"> • Standard • Option 	According to IEC 60529: IP22 (air cooling), IP43 (water cooling) IP42 (air cooling), IP54 (water cooling)
Protection class	Protection class I acc. to IEC 61800-5-1
Shock-hazard protection	DIN EN 50274/VDE 0660 T514 and BGV A3 when used for the intended application
Interference emission	This drive unit is part of a PDS, Category C4 acc. to IEC 61800-3. It has not been designed to be connected to the public line supply. EMC disturbances can occur when connected to these line supplies. The essential requirements placed on EMC protection for the drive system should be secured using an EMC plan on the customer side.
Paint finish/color	Indoor requirements/RAL 7035, light gray

General technical data	
Applicable standards and directives <ul style="list-style-type: none"> • Standards 	IEC 61800-3 IEC 61800-5-1 And if referenced in the standards above: IEC 61800-2 IEC 60146-1-1 IEC 60204-11, however, structuring principles and reference marking according to IEC 61346-1 instead of IEC 81346-1
<ul style="list-style-type: none"> • EU directives 	2014/35/EU: Low Voltage Directive 2014/30/EU: Electromagnetic Compatibility
Conformity with other directives	EAC TR TC 020/2011 (electromagnetic compatibility) The converter rating plate has an EAC marking.
Water cooling	Water-water cooling unit, internal circuit, deionized water
Permissible coolant temperature (raw water) <ul style="list-style-type: none"> • Inlet • Discharge 	+5 ... +35 °C ¹⁾ +40 °C ²⁾

1) With derating also higher values (see section 3.7.2); values lower than +5 °C on request

2) Higher values on request

Rated data	
Output voltage	3.3 kV
Input voltage	2 x 1.7 kV
Input voltage tolerance	±10 %
Line frequency	50/60 Hz ±5 %
Line power factor fundamental mode	> 0.96

Control-related properties	Operation of induction motors		Operation of separately excited synchronous motors
	Without speed encoder	With speed encoder	With speed encoder
Operating range			
Lower limit of speed control range (% of rated motor speed)	0 %	0 %	0 %
Max. permissible output frequency	250 Hz	250 Hz	90 Hz
Field weakening range	1:3	1:3	1:4
Steady-state operation			
Speed accuracy (% of rated motor speed)	±0.2 % (from 5 % of rated speed)	±0.01 %	±0.01 %
Torque accuracy (% of rated torque)	±5 % (from 5 % of rated speed)	±5 %	±2 %
Dynamic operation			
Torque rise time	5 ms	5 ms	5 ms

3.7 Technical specifications

	Storage	Transport	Operation
Climatic environmental conditions			
Ambient temperature	–25 ... +70 °C	–25 ... +70 °C	+5 ... +40 °C
Relative humidity	5 ... 95 % (only slight condensation permitted; converter must be completely dry before commissioning)	5 ... 95 % (only slight condensation permitted; converter must be completely dry before commissioning)	5 ... 85 % (condensation not permissible)
Other climatic conditions in accordance with Class	1K22 according to IEC 60721-3-1 (icing not permissible)	2K11 according to IEC 60721-3-2	3K22 according to IEC 60721-3-3
Degree of pollution	2 without conductive pollution according to IEC 61800-5-1	2 without conductive pollution according to IEC 61800-5-1	2 without conductive pollution according to IEC 61800-5-1
Mechanical environmental conditions			
in accordance with Class (increased strength for marine use)	1M11 according to IEC 60721-3-1	2M4 according to IEC 60721-3-2	3M11 according to IEC 60721-3-3
Other environmental conditions			
Biological environmental conditions in accordance with Class	1B1 according to IEC 60721-3-1	2B1 according to IEC 60721-3-2	3B1 according to IEC 60721-3-3 (without harmful flora)
Chemically active substances in accordance with Class	1C1 according to IEC 60721-3-1	2C1 according to IEC 60721-3-2	3C1 according to IEC 60721-3-3:1994 (no occurrence of salt mist)
Mechanically active substances in accordance with Class	1S11 according to IEC 60721-3-1	2S1 according to IEC 60721-3-2	3S6 according to IEC 60721-3-3

Note:

The values specified under storage and transport apply to suitably packed converters.

3.7.2 Derating for special installation conditions

Current derating

If the converters are operated at installation altitudes above 1000 m above sea level or with intake temperatures in the cooling unit > 35 °C, derating factors k_H or k_T must be taken into account for the rated output current (DIN 43671). The following applies for the permissible continuous current I :

$$I \leq I_N \times k_H \times k_T$$

I : permitted continuous current

I_N : rated current

The derating factors are shown in the following diagrams.

Note

The characteristics for installation altitudes up to 5000 m and higher raw water intake temperatures are available on request.

Current derating as a function of the installation altitude (water cooling)

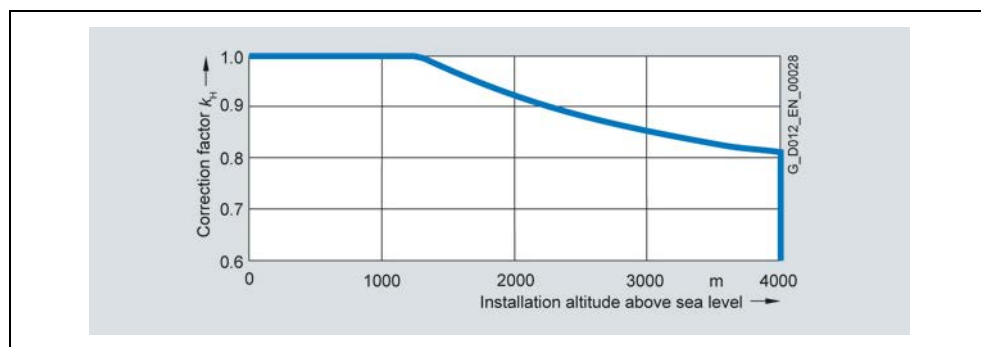

Fig. 3-10 Derating factor k_H for water cooling

Current derating as a function of the raw water intake temperature

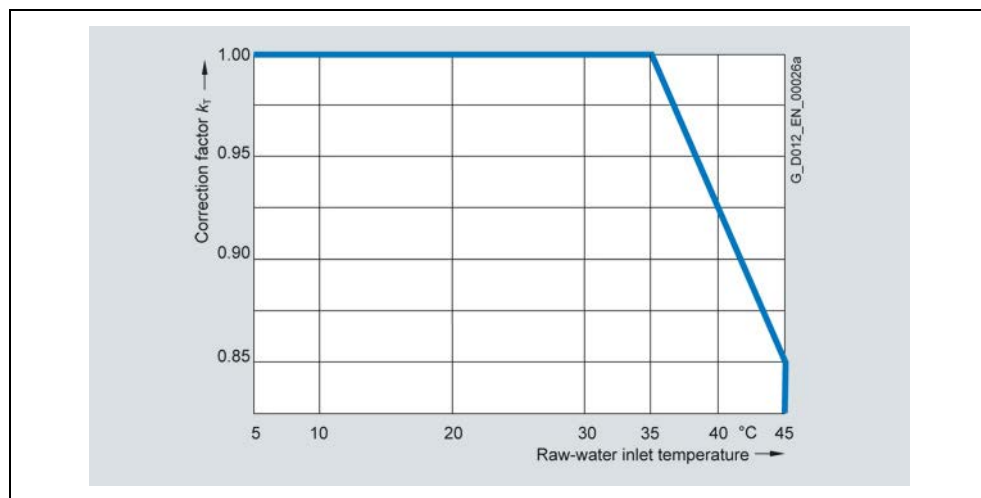

Fig. 3-11 Derating factor k_T (raw water intake temperature)

Voltage derating

For installation altitudes >2000 m, acc. to IEC 60664-1 in addition to a current derating, a voltage derating is also required. This depends on the air and creepage distances in the unit.

Voltage derating as a function of the installation altitude

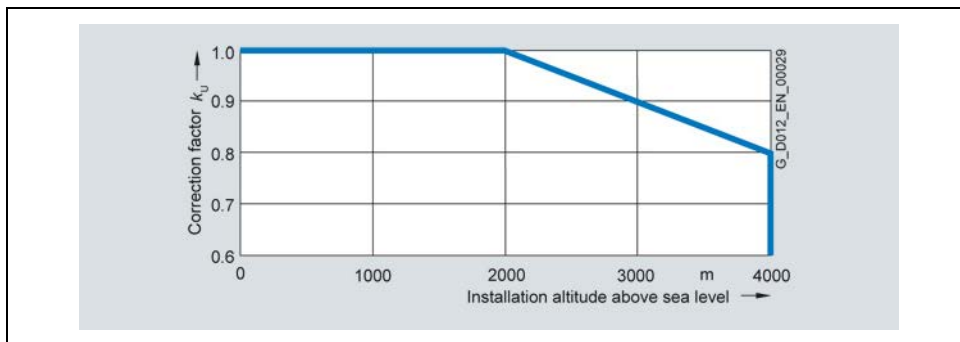

Fig. 3-12 Derating factor k_U

Example

Derating data SINAMICS GM150 in the IGCT version

Drive unit	6SL3835-2LN43-6AA3
Output voltage	3.3 kV
Input voltage	$2 \times (2 \times 1.7)$ kV
Type rating	18000 kVA, 2×1570 A
Installation altitude	2000 m
Raw water intake temperature	40 °C
k_H (water cooling)	0.925
k_T (raw water intake temperature)	0.925
k_U	1.0

For the current, the following applies:

$$I \leq I_N \times 0.925 \times 0.925 = I_N \times 0.856$$

A current derating of 14.4 % is required.

The maximum available output current is 1344 A for each subsystem.

3.7.3 Type-specific technical data

The type-specific technical data for SINAMICS GM150 converters in the IGCT version are listed in the following table.

SINAMICS GM150 IGCT version Water cooling		Article number: 6SL3835-...					
		...2LN41-8AA3	...2LN42-1AA3	...2LN42-3AA3	...2LN42-8AA3	...2LN43-6AA3	...2LN44-2AA3
Output voltage 3.3 kV							
Type rating	kVA	10000	12000	15500	15500	18000	21000
Shaft output ¹⁾	kW	8000	9850	13000	13000	15000	17000
	hp	11000	13200	17000	17000	20000	23000
Rated output current	A	1750	2100	2x1360	2x1360	2x1570	3x1220
Max. thermal output current	A	1750	2100	2x1380	2x1440	2x1660	3x1630
Max. motor short-circuit current	A	8700	8700	6900	7200	8300	8100
Input voltage	kV	2x1.7	2x1.7	2x1.7	2x(2x1.7)	2x(2x1.7)	3x(2x1.7)
Rated input current ¹⁾	A	2x1550	2x1690	2x2480	2x(2x1240)	2x(2x1450)	3x(2x1150)
Power loss ^{2) 3)}	kW	80	90	110	128	160	192
Efficiency ³⁾	%	99.1	99.25	99.2	99.1	99.1	99.1
Typical current demand of the auxiliary supply 230 V 1 AC 50/60 Hz ⁴⁾	A	3	3	6	6	6	9
Max. current demand of the auxiliary supply 400 V 3 AC 50/60 Hz	A	17	17	20	20	20	23
Precharging current demand, for approx. 25s	A	20	20	22	40	40	60
Raw water flow rate	l/min	208	208	375	417	417	667
Deionized water volume	l	35	35	60	70	70	105
Sound pressure level L _{pA} (1m)	dB	75	75	76	77	77	79
Measuring surface level L _s (1m)	dB	22	22	23	23	23	24
Cable cross-sections, line-side, max. connectable per phase ^{5) 6)}	mm ² (DIN VDE)	4 x 240	4 x 240	4 x 240	4 x 240	4 x 240	4 x 240
	MCM (NEC,CEC)	4 x 500	4 x 500	4 x 500	4 x 500	4 x 500	4 x 500
Cable cross-sections, motor-side, max. connectable per phase ^{5) 6)}	mm ² (DIN VDE)	4 x 240	4 x 240	4 x 240	4 x 240	4 x 240	4 x 240
	MCM (NEC,CEC)	4 x 500	4 x 500	4 x 500	4 x 500	4 x 500	4 x 500
PE connection, max. cross-section at the enclosure with M12 screw ⁵⁾	mm ² (DIN VDE)	3 x 120	3 x 120	2 x 120	6 x 120	6 x 120	9 x 120
	MCM (NEC,CEC)	3 x 250	3 x 250	2 x 250	6 x 250	6 x 250	9 x 250
Degree of protection	–	IP43	IP43	IP43	IP43	IP43	IP43
Dimensions ⁷⁾	Width	mm	5300	5300	7900	9700	14300
	Height ⁸⁾	mm	2540	2540	2540	2540	2540
	Depth	mm	1600	1600	1600	1600	1600
Circuit version	Fig. No.	7	7	7p	9	9	10
Weight ⁷⁾	kg	4800	4800	7800	9600	9600	14400

1) The data for the rated input current and the power data in hp and kW are approximate values only; these have been calculated for operation with induction motors and for a typical motor power factor cos φ and motor efficiency, which are obtained by selecting the following values: Motor power factor between 0.85 and 0.88 and a motor efficiency of 96 %. The rated input current also depends on the line power factor, for which a typical value of between 0.94 and 0.96 was assumed.
The hp data are based on the NEC and CEC guidelines for the North American market. The kW values are specified in multiples of 50. Both approximate values need to be adapted to the motor which is actually used.

2) Approx. 5% of the power loss is dissipated to the room.
3) Without cooling system
4) The typical current drawn (rms value; cos φ_{typ.} = 0.6) of the supply for the converter open-loop/closed-loop control is specified. The separate supplies for the socket outlets/light or switched auxiliary power feeders (options **N35 to N38**) have not been taken into account.

Values for the typical current drawn for special configurations (e.g. for dimensioning an upstream UPS) are available on request. When using options **L48** (make-proof grounding switch at the converter input), **L49** (make-proof grounding switch at the converter output) or **L51** (disconnector at the converter output), it should further be taken into account that for switching operations, additional peak values of up to 10 A can occur for each make-proof grounding switch or disconnector. This corresponds to the starting current of a motor used to operate a switch, which decays from approx. 10 A to approx. 2 A in 200 ms. A switching operation takes a total time of approx. 2 s. All optionally used make-proof grounding switches or disconnectors are controlled via the manually actuated make-proof grounding switch for the converter DC link (standard) and therefore switch simultaneously!

5) Data refer to a sub-system; for details about the number of sub-systems to be connected on the line or motor side, see circuit versions.
6) The maximum permissible cable lengths must be observed (see power cables 11.7).
7) The specified dimensions and weights include doors, panels and cooling unit, however no options.
8) Depending on the pressure equalization tank, the cooling unit can have a maximum cabinet height of 2900 mm

4 SINAMICS SM150 IGBT version

4.1 Overview



Fig. 4-1 SINAMICS SM150 in the IGBT version

SINAMICS SM150 converters in the IGBT version, capable of energy recovery, are available as single-motor drives with IGBT power semiconductors.

IGBT converters are available for the following voltages and power ranges.

Rated output voltage	Type rating for air cooling	Type rating for water cooling
3.3 kV	3.4 and 4.6 MVA	4.6 and 5.7 MVA
4.16	4.3 and 5.8 MVA	5.8 and 7.2 MVA

The rated power in the specific application will depend on the necessary load cycle.

Note:

For other technical requirements that have to be taken into consideration (surge loads, operation at low frequencies) please contact your Siemens sales partner with the required specifications.

Global use

SINAMICS SM150 converters in the IGBT version are manufactured to international standards and regulations, making them ideally suited for global use.

4.2 Benefits

- Compact design and highly flexible configuration ensures easy plant integration
- Simple operator control and monitoring from the user-friendly operator panel
- Simple and reliable operation through integrated maintenance functions: The converter signals early on and automatically if maintenance is required or components need to be replaced
- High degree of ruggedness and reliability by using HV IGBT technology and a fuseless design combined with intelligent response to external disturbances
- Can be easily integrated into automation solutions as the PROFINET interface is supplied as standard along with various analog and digital interfaces
- High level of service-friendliness through innovative power section design with plug-in Powercards and easy access to all components
- By appropriately engineering the drive system, reactive power can be made available to other drives, therefore helping ensure that the plant or system is cost effective.

4.3 Design

Active Line Modules and Motor Modules have an identical design. HV IGBT power semiconductors are used in both – they are mounted on plug-in Powercards that are simple to replace.

In the basic circuit, one Active Line Module and one Motor Module are interconnected via a DC link.

The converter consists of cabinet units for the Active Line Module and for the Motor Module. In the following diagram, one Powercard and the Control Unit are marked in the Motor Module.

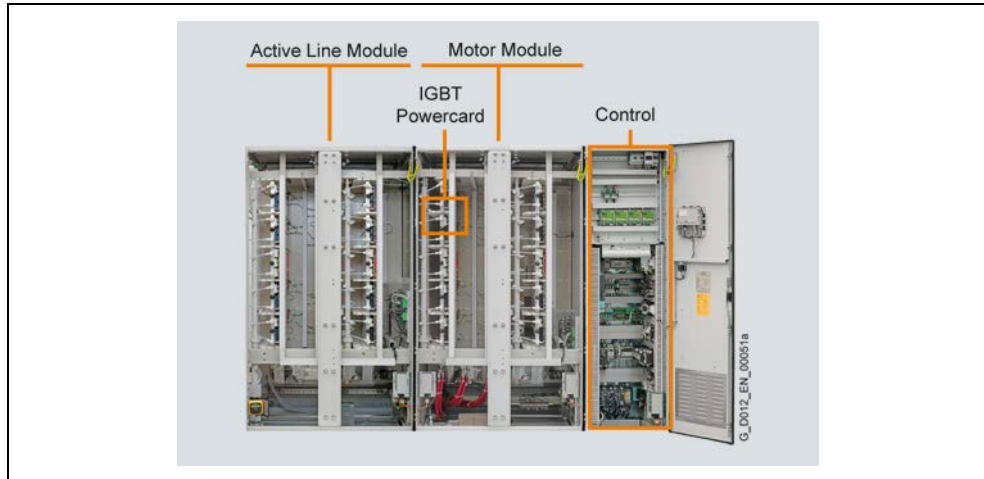

Fig. 4-2 SINAMICS SM150 in the IGBT version, water cooling, internal design without cooling unit

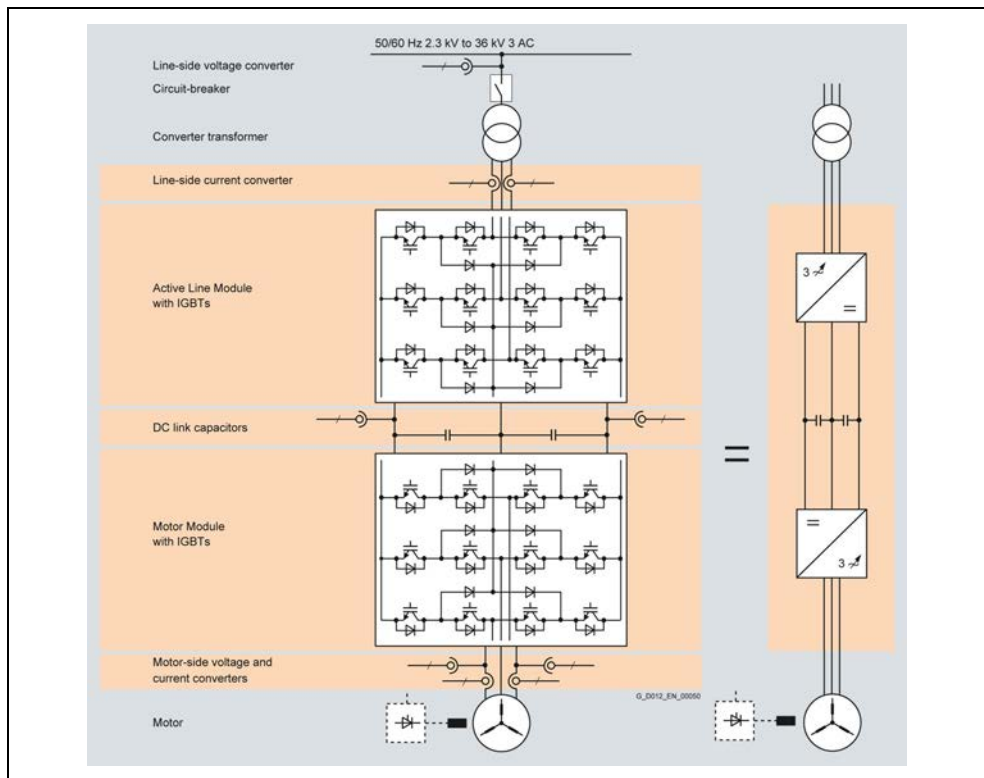

Fig. 4-3 Block diagram

The following circuit version is available for SINAMICS SM150 in the IGBT version.

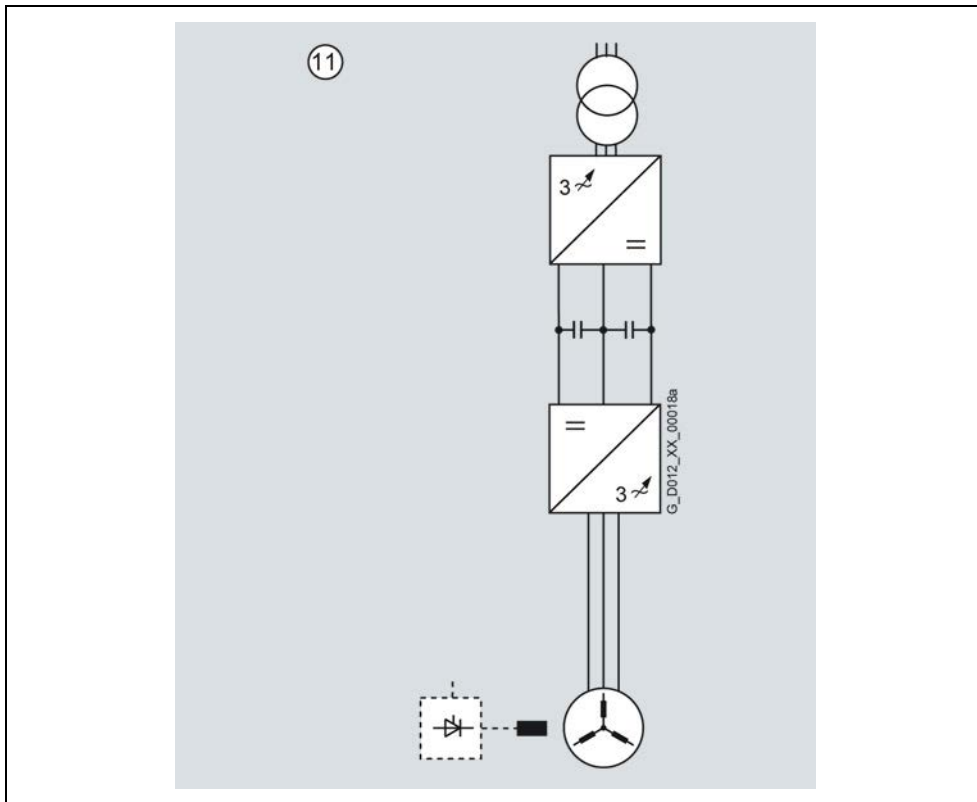

Fig. 4-4 Basic circuit

4.4 Function

Characteristic features

SINAMICS SM150 in the IGBT version	
Line Module (line-side rectifier)	
Active Line Module (four-quadrant operation)	Standard
Motor Module (motor-side inverter)	
Voltage range	3.3 kV / 4.16 kV
Power range (typ.)	3.4 ... 7.2 MVA
Cooling method	
<ul style="list-style-type: none"> • Air cooling • Water cooling 	Standard Standard
Control modes	<u>Without encoder</u>
<ul style="list-style-type: none"> • Induction motor • Synchronous motor, separately excited with slipring excitation • Synchronous motor, separately excited with brushless reverse field excitation • Synchronous motor, permanently excited 	Standard Option On request On request

Software and protection functions

SINAMICS SM150 in the IGBT version	Description
Closed-loop control	<p>The motor-side closed-loop control is realized as a field-oriented closed-loop vector control that can be operated as a speed or torque control as required. The closed-loop vector control achieves the dynamic performance of a DC drive. This is made possible by the fact that the current components forming the torque and flux can be controlled precisely independently of each other. Prescribed torques can thus be observed and limited accurately. In the speed range from 1:10, the field-oriented closed-loop control does not require an actual speed value encoder.</p> <p>An actual speed value encoder is required in the following scenarios:</p> <ul style="list-style-type: none"> • High dynamics requirements • Torque control/constant torque drives with a control range > 1:10 • Very low speeds • Very high speed accuracy
Setpoint input	<p>The setpoint can be defined internally or externally; internally as a fixed setpoint, motorized potentiometer setpoint or jog setpoint, externally via the PROFINET interface or an analog input of the customer terminal block. The internal fixed setpoint and the motorized potentiometer setpoint can be switched over or adjusted using control commands via all of the interfaces.</p>
Ramp-function generator	<p>A user-friendly ramp-function generator with separately adjustable ramp-up and ramp-down times, together with variable smoothing times in the lower and upper speed ranges, improves the control response and therefore prevents mechanical overloading of the drive train. The ramp-down ramps can be parameterized separately for emergency stop.</p>

SINAMICS SM150 in the IGBT version	Description
Kinetic buffering	Power supply failures are bridged to the extent permitted by the kinetic energy of the drive train. The speed drops depending on the moment of inertia and the load torque. The current speed setpoint is resumed when the power supply returns. Kinetic buffering is not available when operating separately excited synchronous motors.
Automatic restart	The automatic restart switches the drive on again when the power is restored after a power failure or a general fault, and ramps up to the actual speed setpoint.
Flying restart	The flying restart function permits smooth connection of the converter to a rotating motor.
Diagnostic functions	<ul style="list-style-type: none"> • Self-diagnosis of control hardware • Non-volatile memory for reliable diagnosis when the power supply fails • Monitoring of HV IGBTs with individual messages for each mounting location • User-friendly on-site operator panel with plain text messages
Operating hours and switching cycles counter	The operating hours of the non-redundant fans, which are located on the roof section of the cabinets, are detected and logged so that preventive maintenance can be performed or equipment replaced as a preventive measure. The switching cycles of the circuit breaker are recorded and added together, to form the basis of preventive maintenance work.
Sensing the actual motor speed (option K50)	The Sensor Module SMC30 can be used to sense the actual motor speed. The signals from the rotary pulse encoder are converted here and made available for evaluation to the closed-loop controller via the DRIVE-CLiQ interface.
Operator protection	The cabinet doors of the power sections are fitted with electromagnetic locks. This prevents the cabinet doors being opened while hazardous voltages are connected inside the cabinet.
EMERGENCY OFF button	The converters are equipped as standard with an EMERGENCY OFF button with protective collar which is fitted in the cabinet door. The contacts of the button are connected in parallel to the terminal block so they can be integrated in a protection concept on the plant side. EMERGENCY OFF stop category 0 is set as standard for an uncontrolled shutdown (IEC 60204-1). The function includes voltage disconnection of the converter output through the circuit breaker. The motor coasts in the process. (The auxiliary power circuits are <i>not</i> disconnected.) Optionally available: Control of the "Safe Torque Off" function (option K80)
Insulation monitoring	The converters feature insulation monitoring of the complete electrical circuit from the secondary side of the transformer to the stator windings of the motor.
Monitoring the peripherals	An extensive package of options for I/O monitoring (from the transformer and the motor through to the auxiliaries) is available. In addition it is possible to monitor the temperature with thermocouples or Pt100 resistors.

SINAMICS SM150 in the IGBT version	Description
Thermal overload protection	<p>An alarm message is issued first when the overtemperature threshold is reached. If the temperature rises further, either a shutdown is carried out or automatic influencing of the output current so that a reduction in the thermal load is achieved. Following elimination of the cause of the fault (e.g. improvement in the ventilation), the original operating values are automatically resumed.</p> <p>For instance, for air-cooled converters and when filter mats are used, the amount of pollution of the filter mats is monitored by measuring the differential pressure which is then signaled. In the case of water-cooled converters, the water temperature and flow rate are recorded at several points in the cooling circuit and evaluated. An extensive self-diagnosis protects the converter and reports faults.</p>
Make-proof grounding switch (options L48, L49)	<p>If grounding on the infeed or motor side is required for safety and protection reasons, a motorized make-proof grounding switch can be ordered.</p> <p>For safety reasons, the converter controller locks these make-proof grounding switches against activation while voltage is still present. The control is integrated into the protection and monitoring chain of the converter. The make-proof grounding switches are inserted automatically when the standard make-proof grounding switches of the DC link are inserted.</p>

SIMATIC HMI TP900 Comfort operator panel

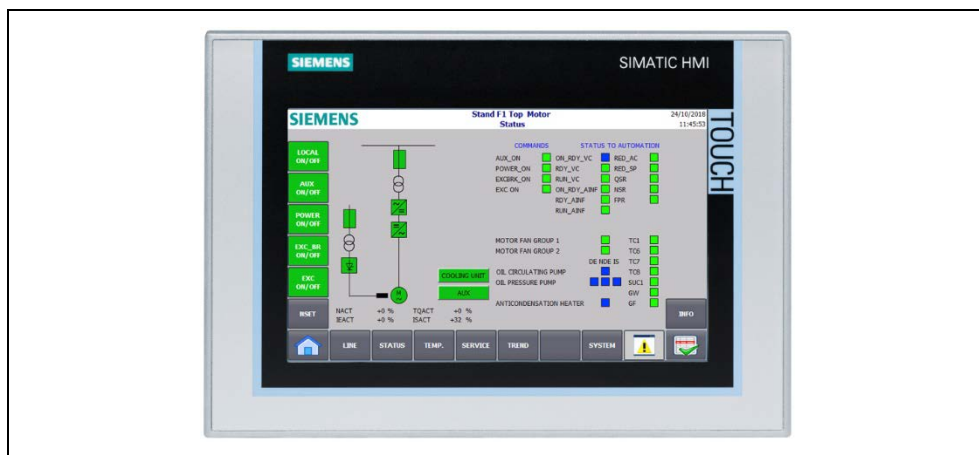

Fig. 4-4 SIMATIC HMI TP900 Comfort

The SIMATIC HMI TP900 Comfort operator panel with touch screen is integrated in the SINAMICS SM150 cabinet door, and is used for operating, monitoring and parameterizing.

It sets itself apart as a result of the following features.

Display	9.0" widescreen TFT display, 16 million colors
Resolution	800 x 480 px
Operator controls	Touch screen
Interfaces	USB port in the cabinet door (e. g. to download trace files)

4.5 Selection and ordering data

Air cooling

Type rating	Shaft output		Rated output current	SINAMICS SM150 in the IGBT version	Circuit version
kVA	kW	hp	A	Article No.	Fig. No.
Output voltage 3.3 kV					
3400	2800	3600	600	6SL3810-7NN36-0AA4	11
4600	3800	4950	800	6SL3810-7NN38-0AA3	11
Output voltage 4.16 kV					
4300	3600	4700	600	6SL3810-7NP36-0AA4	11
5800	4800	6500	800	6SL3810-7NP38-0AA3	11

Water cooling

Type rating	Shaft output		Rated output current	SINAMICS SM150 in the IGBT version	Circuit version
kVA	kW	hp	A	Article No.	Fig. No.
Output voltage 3.3 kV					
4600	3800	4950	800	6SL3815-7NN38-0AA4	11
5700	4700	6350	1000	6SL3815-7NN41-0AA3	11
Output voltage 4.16 kV					
5800	4800	6500	800	6SL3815-7NP38-0AA4	11
7200	5900	8000	1000	6SL3815-7NP41-0AA3	11

Note:

For other technical requirements that have to be taken into consideration (surge loads, operation at low frequencies) please contact your Siemens sales partner with the required specifications.

4.6 Technical specifications

4.6.1 General technical data

General technical data	
Power components	3.3 kV IGBTs
Line-side converter	Active Line Module: Regulated, self-commutating feed/feedback unit
Motor-side converter	Motor Module: Inverter
Closed-loop control	Vector control
Drive quadrants	4 (driving and braking per 2 directions of rotation)
Electrically isolated power section/open-loop and closed-loop control	Fiber optic cable, isolating transformer
Auxiliary power supply (for fans, coolant pumps, precharging the DC link capacitors, open-loop and closed-loop control)	230 V 1 AC $\pm 10\%$, 50/60 Hz $\pm 3\%$ and 400 V 3 AC $\pm 10\%$, 50/60 Hz $\pm 3\%$ or another auxiliary voltage (options C30 to C55)
Installation altitude	≤ 1000 m above sea level: 100 % load capability > 1000 ... 4000 m above sea level: current derating required > 2000 ... 4000 m above sea level: voltage derating required in addition
Insulation	According to IEC 61800-5-1: Pollution degree 2 (without conductive pollution), condensation not permissible
Degree of protection	According to IEC 60529: IP22 (air cooling) IP43 (water cooling)
Protection class	Protection class I acc. to IEC 61800-5-1
Shock-hazard protection	DIN EN 50274/VDE 0660 T514 and BGV A3 when used for the intended application
Interference emission	This drive unit is part of a PDS, Category C4 acc. to IEC 61800-3. It has not been designed to be connected to the public line supply. EMC disturbances can occur when connected to these line supplies. The essential requirements placed on EMC protection for the drive system should be secured using an EMC plan on the customer side.
Paint finish/color	Indoor requirements/RAL 7035, light gray

General technical data	
Applicable standards and directives <ul style="list-style-type: none"> • Standards • EU directives 	IEC 61800-3 IEC 61800-5-1 And if referenced in the standards above: IEC 61800-2 IEC 60146-1-1 IEC 60204-11, however, structuring principles and reference marking according to IEC 61346-1 instead of IEC 81346-1 2014/35/EU: Low Voltage Directive 2014/30/EU: Electromagnetic Compatibility
Conformity with other directives	EAC TR TC 020/2011 (electromagnetic compatibility) The converter rating plate has an EAC marking.
Air cooling	Forced air cooling with integrated fans
Water cooling	Water-water cooling unit, internal circuit, deionized water
Permissible coolant temperature (raw water) <ul style="list-style-type: none"> • Inlet • Discharge, max. 	+5 ... +35 °C ¹⁾ +40 °C ²⁾

1) With derating also higher values (see section 4.6.2); values lower than +5 °C on request

2) Higher values on request

Rated data		
Output voltage	3.3 kV	4.16 kV
Input voltage	3.3 kV	4.16 kV
Input voltage tolerance	±10 %	±10 %
Line frequency	50/60 Hz ±5 %	50/60 Hz ±5 %
Line power factor fundamental mode	1	1

Control-related properties	Operation of induction motors		Operation of separately excited synchronous motors
	Without speed encoder	With speed encoder	With speed encoder
Operating range			
Lower limit of speed control range (% of rated motor speed)	0 %	0 %	0 %
Max. permissible output frequency	250 Hz	250 Hz	90 Hz
Field weakening range	1:3	1:3	1:4
Steady-state operation			
Speed accuracy (% of rated speed)	±0.2 % (from 5 % of rated speed)	±0.01 %	±0.01 %
Torque accuracy (% of rated torque)	±5 % (from 5 % of rated speed)	±5 %	±2 %
Dynamic operation			
Torque rise time	5 ms	5 ms	5 ms

	Storage	Transport	Operation
Climatic environmental conditions			
Ambient temperature	-25 ... +70 °C	-25 ... +70 °C	+5 ... +40 °C
Relative humidity	5 ... 95 % (only slight condensation permitted; converter must be completely dry before commissioning)	5 ... 95 % (only slight condensation permitted; converter must be completely dry before commissioning)	5 ... 85 % (condensation not permissible)
Other climatic conditions in accordance with Class	1K22 according to IEC 60721-3-1 (icing not permissible)	2K11 according to IEC 60721-3-2	3K22 according to IEC 60721-3-3
Degree of pollution	2 without conductive pollution according to IEC 61800-5-1	2 without conductive pollution according to IEC 61800-5-1	2 without conductive pollution according to IEC 61800-5-1
Mechanical environmental conditions			
in accordance with Class (increased strength for marine use)	1M11 according to IEC 60721-3-1	2M4 according to IEC 60721-3-2	3M11 according to IEC 60721-3-3
Other environmental conditions			
Biological environmental conditions in accordance with Class	1B1 according to IEC 60721-3-1	2B1 according to IEC 60721-3-2	3B1 according to IEC 60721-3-3 (without harmful flora)
Chemically active substances in accordance with Class	1C1 according to IEC 60721-3-1	2C1 according to IEC 60721-3-2	3C1 according to IEC 60721-3-3:1994 (no occurrence of salt mist)
Mechanically active substances in accordance with Class	1S11 according to IEC 60721-3-1	2S1 according to IEC 60721-3-2	3S6 according to IEC 60721-3-3

Note:

The values specified under storage and transport apply to suitably packed converters.

4.6.2 Derating for special installation conditions

Current derating

If the converters are operated at installation altitudes from 1000 m above sea level or at ambient/coolant temperatures > 40 °C for air cooling or with intake temperatures in the cooling unit > 35 °, derating factors k_H or k_T must be taken into account for the rated current (DIN 43671). The following applies for the permissible continuous current I :

$$I \leq I_N \times k_H \times k_T$$

I : permitted continuous current

I_N : rated current

The derating factors are shown in the following diagrams.

Note

The characteristics for installation altitudes up to 5000 m and higher ambient temperatures or raw water intake temperatures are available on request.

Current derating as a function of the installation altitude (air cooling)

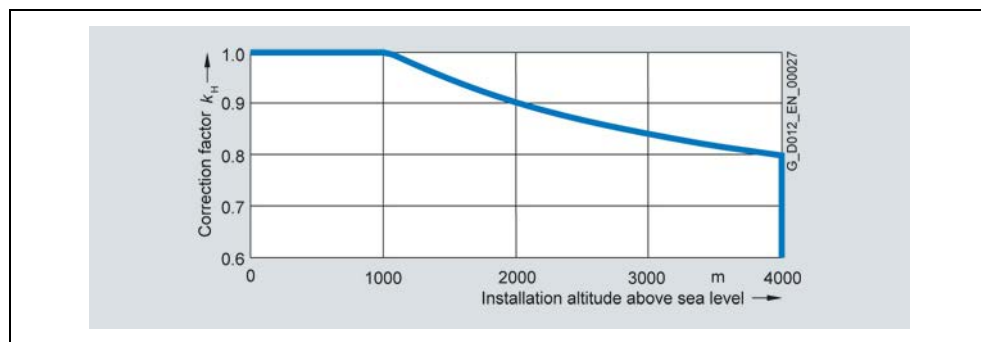

Fig. 4-5 Derating factor k_H for air cooling

Current derating as a function of the installation altitude (water cooling)

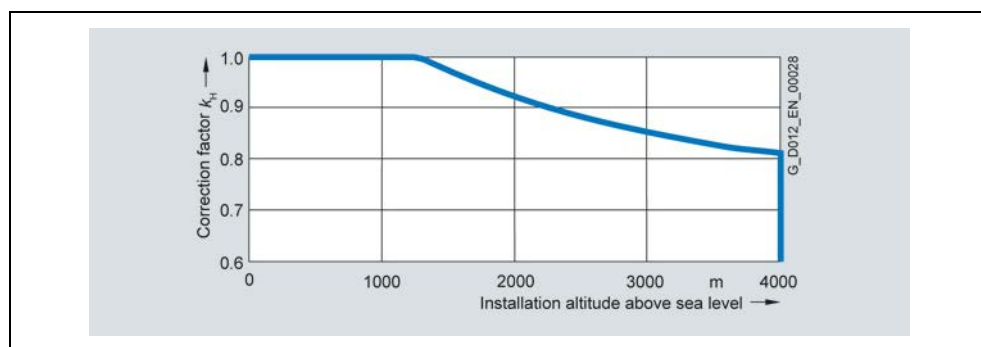

Fig. 4-6 Derating factor k_H for water cooling

Current derating as a function of the ambient temperature

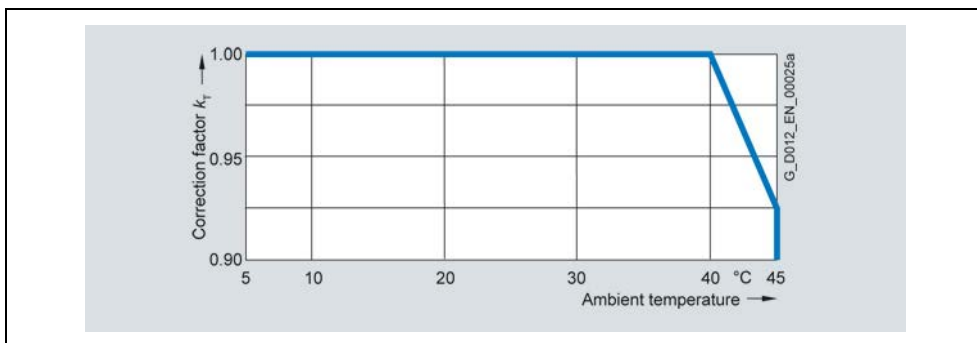

Fig. 4-7 Derating factor k_T (ambient temperature)

Current derating as a function of the raw water intake temperature

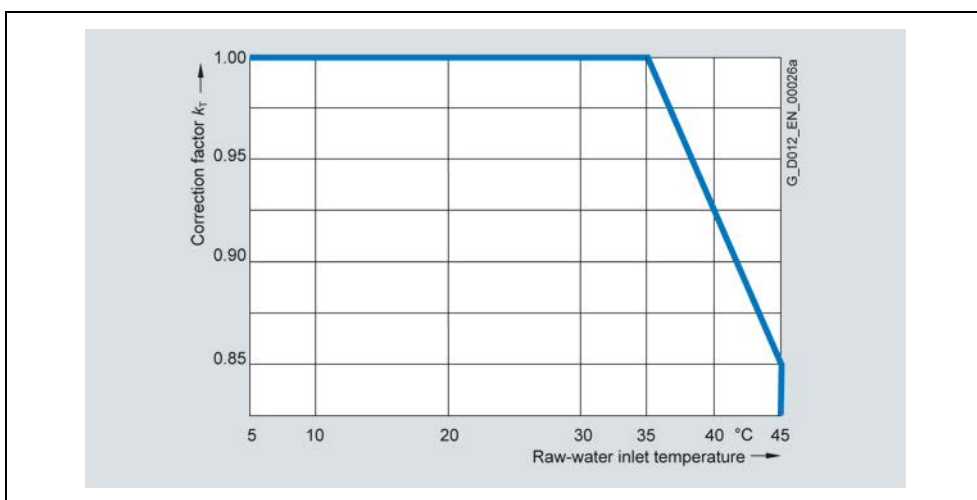

Fig. 4-8 Derating factor k_T (raw water intake temperature)

Voltage derating

For installation altitudes >2000 m, acc. to IEC 60664-1 in addition to a current derating, a voltage derating is also required. This depends on the air and creepage distances in the unit.

Voltage derating as a function of the installation altitude

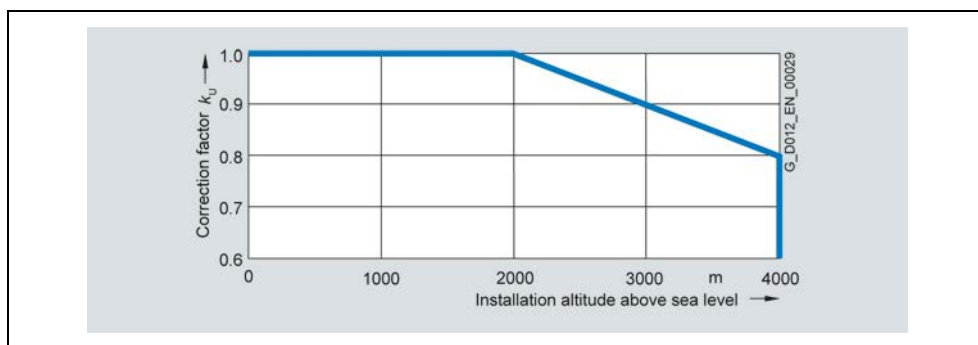

Fig. 4-9 Derating factor k_u

Example

Derating data SINAMICS GM150 in the IGCT version (water-cooled converter)

Drive unit	6SL3815-7NN38-0AA3
Output voltage	3.3 kV
Input voltage	3.3 kV
Type rating	4600 kVA, 800 A
Installation altitude	2000 m
Raw water intake temperature	40 °C
k_H (water cooling)	0.925
k_T (raw water intake temperature)	0.925
k_U	1.0

For the current, the following applies:

$$I \leq I_N \times 0.925 \times 0.925 = I_N \times 0.856$$

A current derating of 14.4 % is required.

The maximum available output current is 685 A.

4.6.3 Type-specific technical data

The type-specific technical data for SINAMICS SM150 converters in the IGBT version are listed in the following tables.

4.6 Technical specifications

SINAMICS SM150 in the IGBT version Air cooling		Article number: 6SL3810-...			
		...7NN36-0AA4	...7NN38-0AA3	...7NP36-0AA4	...7NP38-0AA3
Output voltage	kV	3.3		4.16	
Type rating	kVA	3400	4600	4300	5800
Shaft output ¹⁾	kW	2800	3800	3600	4800
	hp	3600	4950	4700	6500
Rated output current	A	600	800	600	800
Input voltage	kV	3.3	3.3	4.16	4.16
Rated input current ¹⁾	A	616	822	616	822
Power loss ²⁾	kW	76	94	98	118
Efficiency ²⁾	%	97.3	97.5	97.3	97.5
Typ. current demand of the auxiliary supply 230 V 1 AC 50/60 Hz ³⁾	A	4	4	4	4
Max. current demand of the auxiliary supply 400 V 3 AC 50/60 Hz ⁴⁾	A	43	43	43	43
Cooling air flow rate	m ³ /s	4.7	4.7	4.7	4.7
Sound pressure level L _{pA} (1m)	dB	85	85	85	85
Measuring surface level L _s (1m)	dB	19	19	19	19
Cable cross-sections, line-side, max. connectable per phase ^{5) 6)}	mm ² (DIN VDE)	3 × 240	3 × 240	3 × 240	3 × 240
	AWG/MCM (NEC, CEC)	3 × 500 MCM	3 × 500 MCM	3 × 500 MCM	3 × 500 MCM
Cable cross-sections, motor-side, max. connectable per phase ^{5) 6)}	mm ² (DIN VDE)	3 × 240	3 × 240	3 × 240	3 × 240
	AWG/MCM (NEC, CEC)	3 × 500 MCM	3 × 500 MCM	3 × 500 MCM	3 × 500 MCM
PE connection, max. cross-section at the enclosure with M12 screw ⁵⁾	mm ² (DIN VDE)	4 × 240	4 × 240	4 × 240	4 × 240
	AWG/MCM (NEC, CEC)	4 × 500 MCM	4 × 500 MCM	4 × 500 MCM	4 × 500 MCM
Degree of protection	–	IP22	IP22	IP22	IP22
Dimensions ⁷⁾	Width	mm	3020	3020	3020
	Height	mm	2570	2570	2570
	Depth	mm	1275	1275	1275
Circuit version	Fig. No.	11	11	11	11
Weight ⁷⁾	kg	2850	2850	2850	2850

1) The data for the rated input current and the power data in hp and kW are approximate values only; these have been calculated for operation with synchronous motors with a motor power factor $\cos \varphi = 1$ and a motor efficiency of 96 %. The calculation is based on the rated output current. The rated input current also depends on the line power factor, for which a typical value of 1 was assumed.

The hp data are based on the NEC and CEC guidelines for the North American market. The kW values are specified in multiples of 50. Both approximate values need to be adapted to the motor which is actually used.

2) Without cooling system.

3) The typical current drawn (rms value);

$\cos(\varphi_{typ.}) = 0.6$ of the supply for the converter open-loop/closed-loop control is specified. The separate supplies for the socket outlets/light or switched auxiliary power feeders (options **N35 to N38**) have not been taken into account.

Values for the typical current drawn for special configurations (e.g. for dimensioning an upstream UPS) are available on request. When using options **L48** (make-proof grounding switch at the converter input), **L49** (make-proof grounding switch at the converter output) or **L51** (disconnecter at the converter output), it should further be taken into account that for switching operations, additional peak values of up to 10 A can occur for each make-proof grounding switch or disconnecter. This corresponds to the starting current of a motor used to operate a switch, which decays from approx. 10 A to approx. 2 A in 200 ms. A switching operation takes a total time of approx. 2 s. All optionally used make-proof grounding switches or disconnecters are controlled via the manually actuated make-proof grounding switch for the converter DC link (standard) and therefore switch simultaneously!

4) Additional 20 A precharging current for 25 s.

5) Data refer to a sub-system; for details about the number of sub-systems to be connected on the line or motor side, see circuit versions.

6) The maximum permissible cable lengths must be observed (see power cables 11.7).

7) The specified dimensions and weights include doors and panels, however no options.

SINAMICS SM150 in the IGBT version Water cooling		Article number: 6SL3815...			
		...-7NN38-0AA4	...-7NN41-0AA3	...-7NP38-0AA4	...- 7NP41-0AA3
Output voltage	kV	3.3		4.16	
Type rating	kVA	4600	5700	5800	7200
Shaft output ¹⁾	kW	3800	4700	4800	5900
	hp	4950	6350	6500	8000
Rated output current	A	800	1000	800	1000
Input voltage	kV	3.3	3.3	4.16	4.16
Rated input current ¹⁾	A	822	1027	822	1027
Power loss ^{2) 3)}	kW	102	115	132	145
Efficiency ³⁾	%	97.3	97.6	97.3	97.6
Typical current demand of the auxiliary supply 230 V 1 AC 50/60 Hz ⁴⁾	A	4	4	4	4
Max. current demand of the auxiliary supply 400 V 3 AC 50/60 Hz ⁵⁾	A	20	20	20	20
Raw water flow rate	l/min	283	283	283	283
Deionized water volume	l	95	95	95	95
Sound pressure level L _{pA} (1m)	dB	76	76	76	76
Measuring surface level L _s (1m)	dB	19	19	19	19
Cable cross-sections, line-side, max. connectable per phase ^{6) 7)}	mm ² (DIN VDE)	3 × 240	3 × 240	3 × 240	3 × 240
	AWG/MCM (NEC, CEC)	3 × 500 MCM	3 × 500 MCM	3 × 500 MCM	3 × 500 MCM
Cable cross-sections, motor-side, max. connectable per phase ^{6) 7)}	mm ² (DIN VDE)	3 × 240	3 × 240	3 × 240	3 × 240
	AWG/MCM (NEC, CEC)	3 × 500 MCM	3 × 500 MCM	3 × 500 MCM	3 × 500 MCM
PE connection, max. cross-section at the enclosure with M12 screw ⁶⁾	mm ² (DIN VDE)	4 × 240	4 × 240	4 × 240	4 × 240
	AWG/MCM (NEC, CEC)	4 × 500 MCM	4 × 500 MCM	4 × 500 MCM	4 × 500 MCM
Degree of protection	–	IP43	IP43	IP43	IP43
Dimensions ⁸⁾	Width	mm	4220	4220	4220
	Height	mm	2280	2280	2280
	Depth	mm	1275	1275	1275
Circuit version	Fig. No.	11	11	11	11
Weight ⁸⁾	kg	3500	3500	3500	3500

1) The data for the rated input current and the power data in hp and kW are approximate values only; these have been calculated for operation with synchronous motors with a motor power factor $\cos \varphi = 1$ and a motor efficiency of 96 %. The calculation is based on the rated output current. The rated input current also depends on the line power factor, for which a typical value of 1 was assumed.
The hp data are based on the NEC and CEC guidelines for the North American market. The kW values are specified in multiples of 50. Both approximate values need to be adapted to the motor which is actually used.

2) Approx. 5% of the power loss is dissipated to the room.

3) Without cooling system

4) The typical current drawn (rms value; $\cos \varphi_{typ.} = 0.6$) of the supply for the converter open-loop/closed-loop control is specified. The separate supplies for the socket outlets/light or switched auxiliary power feeders (options **N35 to N38**) have not been taken into account.

Values for the typical current drawn for special configurations (e.g. for dimensioning an upstream UPS) are available on request. When using options **L48** (make-proof grounding switch at the converter input), **L49** (make-proof grounding switch at the converter output) or **L51** (disconnecter at the converter output), it should further be taken into account that for switching operations, additional peak values of up to 10 A can occur for each make-proof grounding switch or disconnecter. This corresponds to the starting current of a motor used to operate a switch, which decays from approx. 10 A to approx. 2 A in 200 ms. A switching operation takes a total time of approx. 2 s. All optionally used make-proof grounding switches or disconnecters are controlled via the manually actuated make-proof grounding switch for the converter DC link (standard) and therefore switch simultaneously!

5) Additional 20 A precharging current for 25 s.

6) Data refer to a sub-system; for details about the number of sub-systems to be connected on the line or motor side, see circuit versions.

7) The maximum permissible cable lengths should be carefully observed (see power cables 11.7).

8) The specified dimensions and weights include doors, panels and cooling unit, however no options.

5 SINAMICS SM150 IGCT version

5.1 Overview



Fig. 5-1 SINAMICS SM150 in the IGCT version

Water-cooled, regenerative feedback SINAMICS SM150 converters in the IGCT version are available as single or multi-motor drives with the well-proven medium-voltage IGCT power semiconductors. With multi-motor drives, a common DC bus enables the direct exchange of energy in generator and motor applications.

IGCT converters are available for the following voltage and outputs.

Rated output voltage	Max. type rating
3.3 kV	10.5 MVA, 21 MVA, 31.5 MVA (for a single circuit, parallel or triple parallel circuit configurations)

The rated power in the specific application will depend on the necessary load cycle.

Note:

For other technical requirements that have to be taken into consideration (surge loads, operation at low frequencies, possibly necessary derating for parallel circuit configurations, limits regarding the maximum permissible short-circuit current) please contact your Siemens sales partner with the required specifications.

Global use

SINAMICS SM150 converters in the IGCT version are manufactured to international standards and regulations, making them ideally suited for global use. These converters are also available in ship-going form (meeting the requirements of all major classification organizations).

5.2 Benefits

- Compact design and highly flexible configuration ensures easy plant integration
- Simple operator control and monitoring from the user-friendly operator panel
- Simple and reliable operation through integrated maintenance functions: The converter signals early on and automatically if maintenance is required or components need to be replaced
- High degree of ruggedness and reliability due to the use of IGCT power semiconductors in the high power range and fuseless design combined with an intelligent response to external disturbances
- Can be easily integrated into automation solutions as the PROFIBUS and PROFINET interfaces are supplied as standard along with various analog and digital interfaces
- High level of service-friendliness through innovative power section design with compact phase modules and easy access to all components
- By appropriately engineering the drive system, reactive power can be made available to other drives, therefore helping ensure that the plant or system is cost effective.

5.3 Design

Active Line Modules and Motor Modules share an almost identical structure with both the single-motor and the multi-motor drive. Phase components in which IGCTs, diodes etc. are grouped together in one compact system are used in both.

Single-motor drive

With a single-motor drive in the basic circuit, one Active Line Module and one Motor Module are connected via a DC link.

For higher output power ratings, two or three complete converter units with isolated DC links are operated in parallel.

Multi-motor drive

With multi-motor drives, up to four power sections are operated on the common DC bus. In addition to the Active Line Module, three Motor Modules with three motors can be operated on the common DC bus where energy can be directly exchanged.

Note:

DC bus configurations with up to seven power sections are available on request (e.g. two Active Line Modules, five Motor Modules).

Cabinet design and circuits

The converter consists of cabinet units for the Active Line Module and for the Motor Module. One of three phase components and the control section in the Motor Module cabinet unit are highlighted in the following illustration.

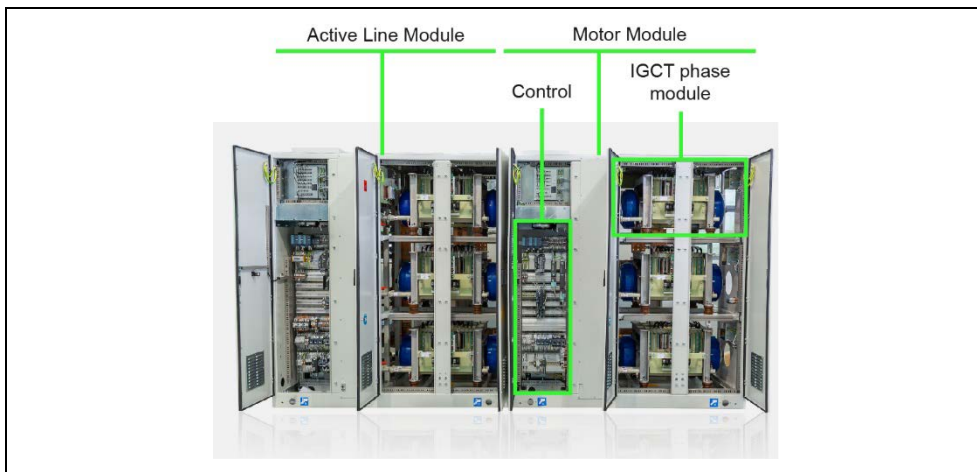

Fig. 5-2 SINAMICS SM150 in the IGCT version, internal design (without cooling unit)

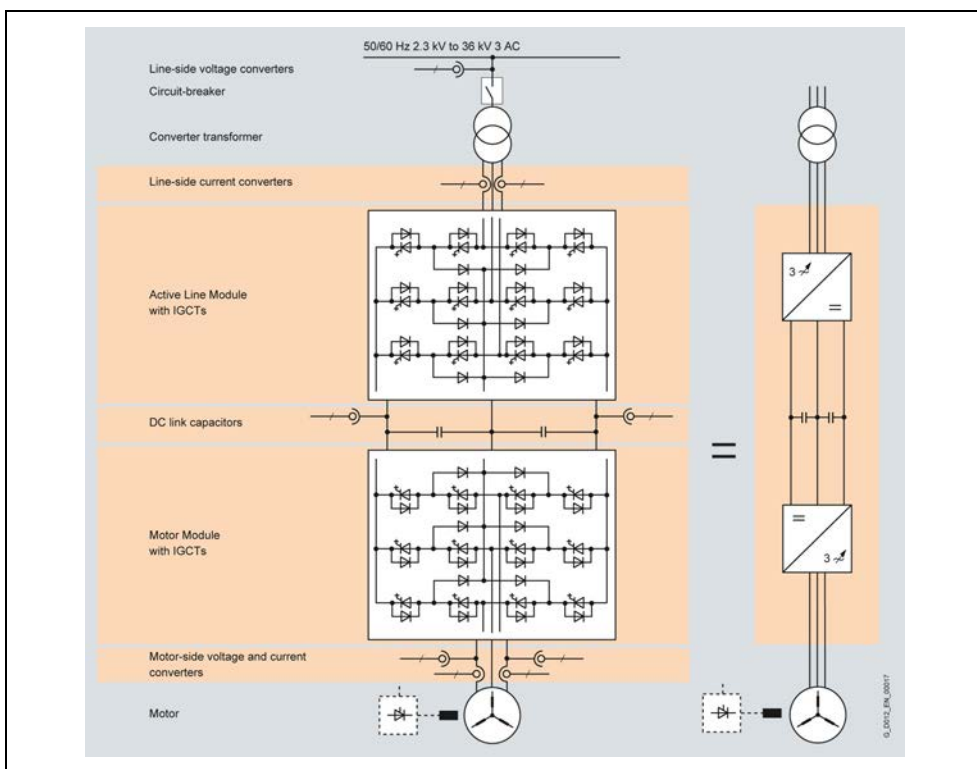

Fig. 5-3 Block diagram

The following circuit versions are available for SINAMICS SM150 in the IGCT version.

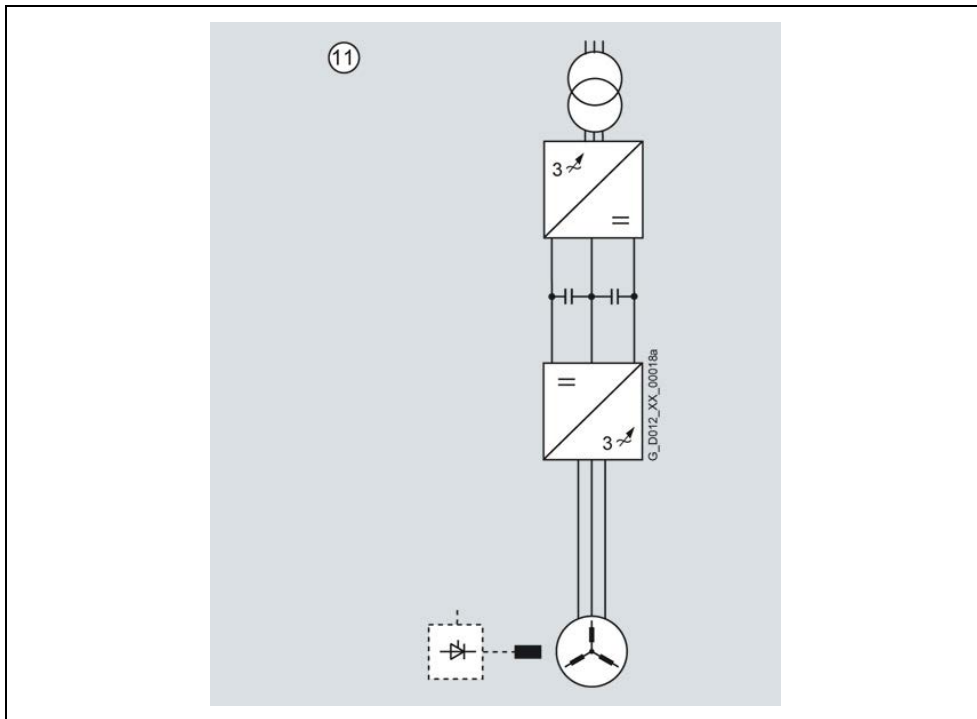

Fig. 5-4 Basic circuit

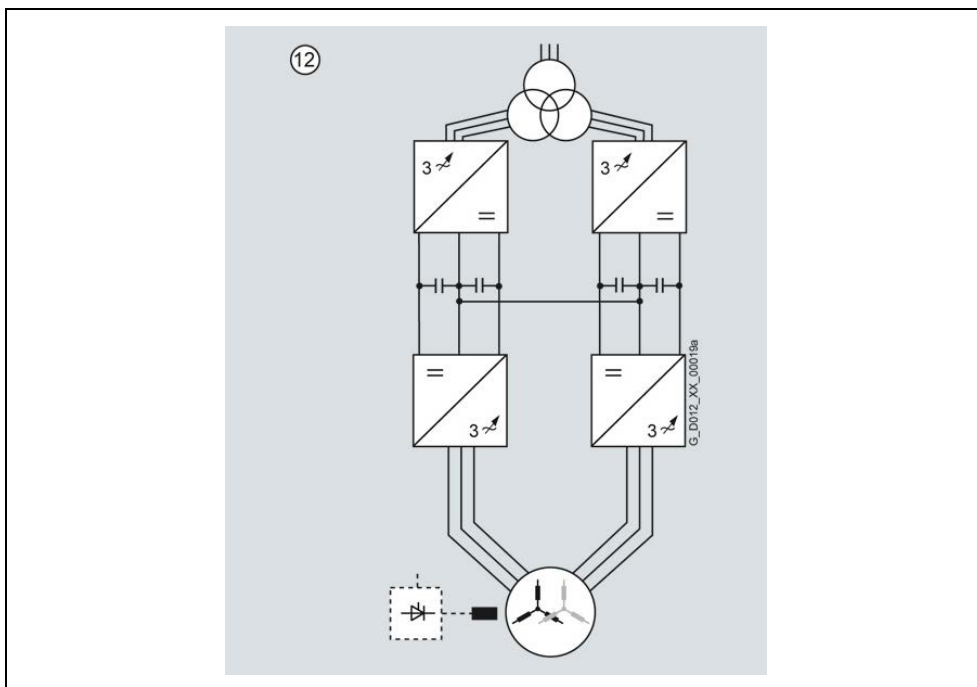

Fig. 5-5 Power rating increased by connecting two converter units in parallel (additional reduction of the line harmonics)¹⁾

1) Requires a motor with separate winding systems.

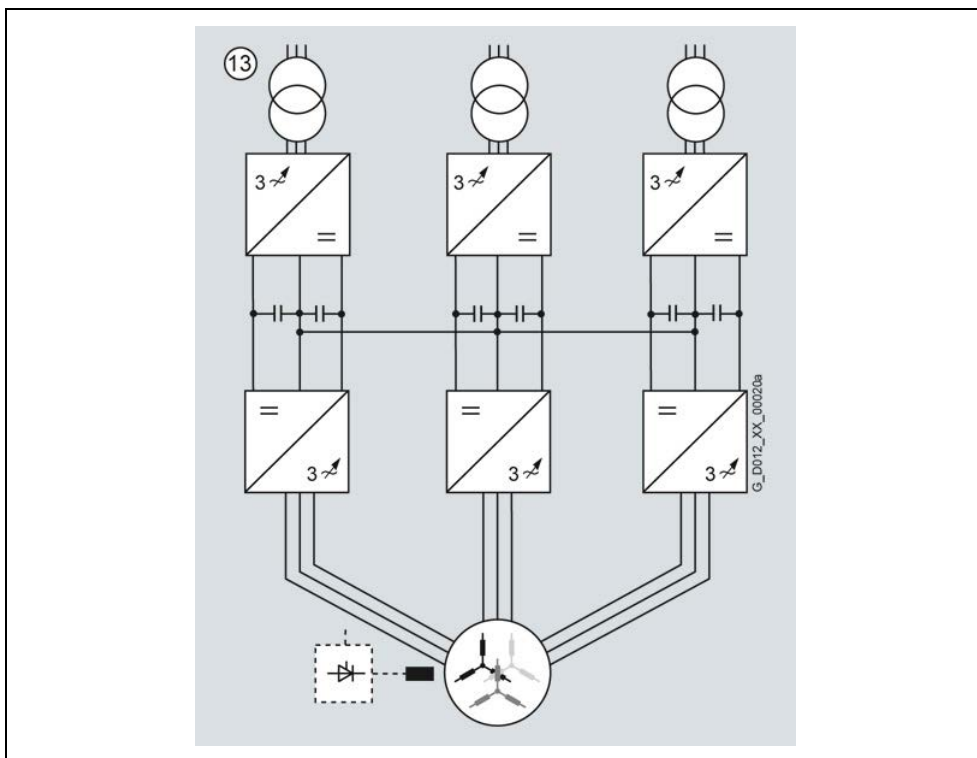

Fig. 5-6 Power rating increased by connecting three converter units in parallel (additional reduction of the line harmonics) ¹⁾

1) Requires a motor with separate winding systems.

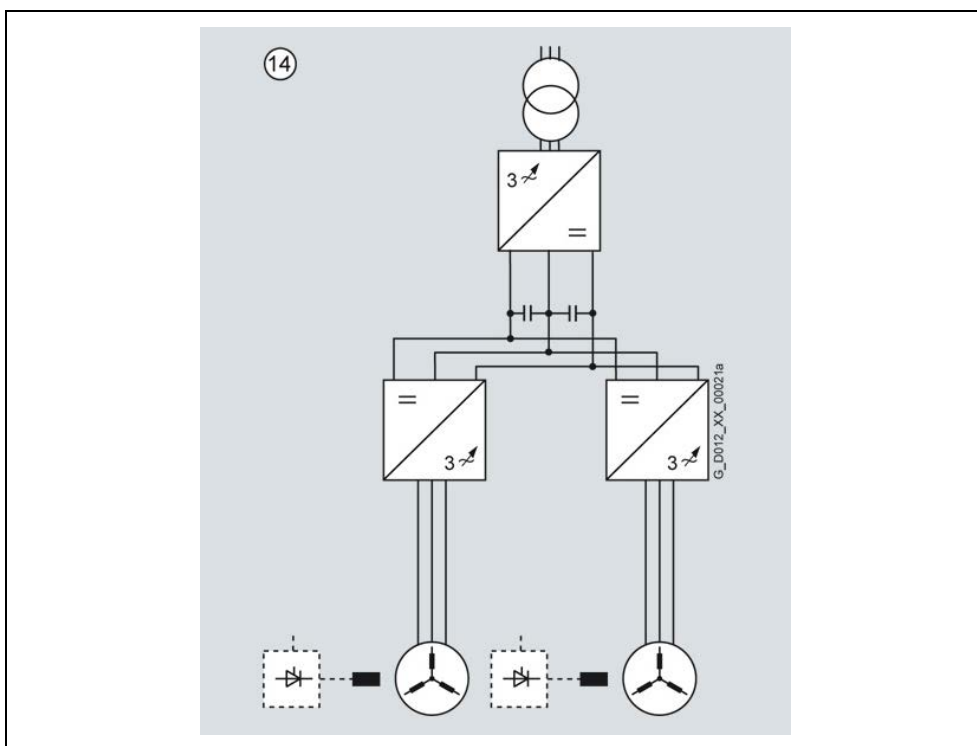

Fig. 5-7 DC bus configuration with two motors connected to a common DC link

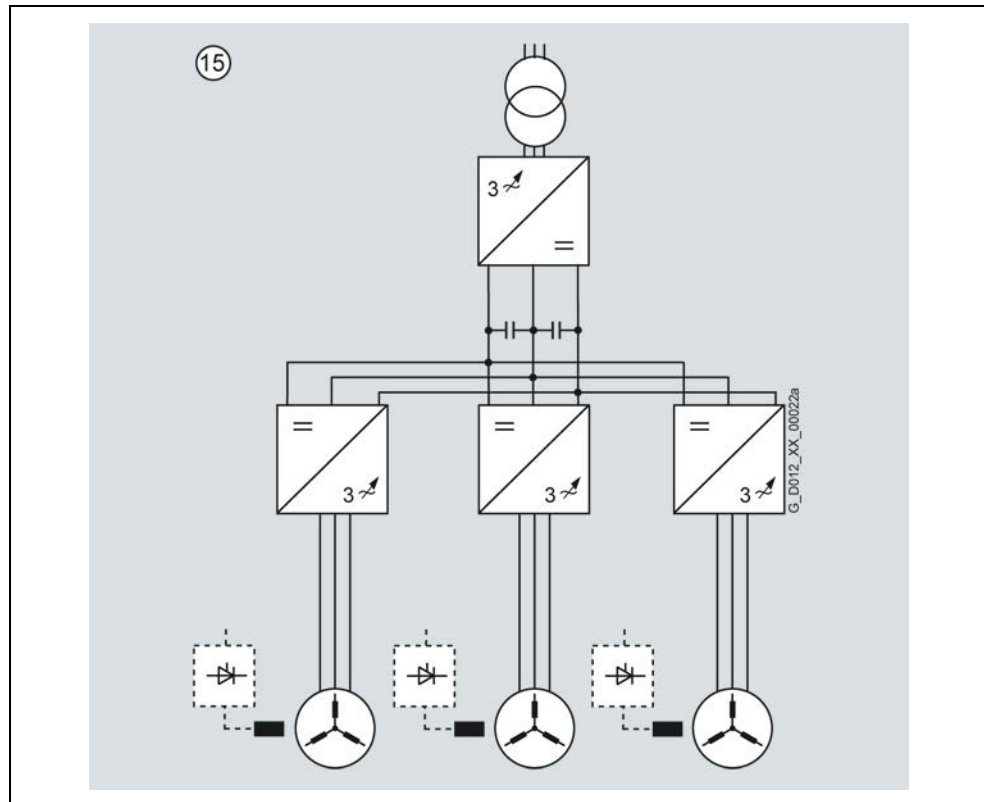

Fig. 5-8 DC bus configuration with three motors connected to a common DC link

For the DC bus configurations with two or more motors, energy can be exchanged along the common DC link between drives that are either motoring or regenerating. This results in savings in the Active Line Module, the transformers and the circuit breakers. These configurations are used mainly for single-stand cold rolling mills with a coiler and for transmission test stands.

Note:

DC bus configurations with up to seven power sections are available on request (e.g. two Active Line Modules, five Motor Modules).

5.4 Function

Characteristic features

SINAMICS SM150 in the IGCT version	
Line Module (line-side rectifier)	
Active Line Module (four-quadrant operation)	Standard
Motor Module (motor-side inverter)	
Voltage range	3.3 kV
Power range (typ.)	5 ... 31.5 MVA
Cooling method • Water cooling	Standard
Control modes • Induction motor • Synchronous motor, separately excited with slipping excitation • Synchronous motor, separately excited with brushless reverse field excitation • Synchronous motor, permanently excited	<u>With encoder is standard</u> Standard Option On request Option
DC bus configuration with several Motor Modules on one common DC bus	Standard

Software and protection functions

SINAMICS SM150 in the IGCT version	Description
Closed-loop control	The motor-side closed-loop control is realized as a field-oriented closed-loop vector control that can be operated as a speed or torque control as required. The closed-loop vector control achieves the dynamic performance of a DC drive. This is made possible by the fact that the current components forming the torque and flux can be controlled precisely independently of each other. Prescribed torques can thus be observed and limited accurately. In the speed range from 1:10, the field-oriented closed-loop control does not require an actual speed value encoder. An actual speed value encoder is required in the following scenarios: <ul style="list-style-type: none"> • High dynamics requirements • Torque control/constant torque drives with a control range > 1:10 • Very low speeds • Very high speed accuracy
Setpoint input	The setpoint can be defined internally or externally; internally as a fixed setpoint, motorized potentiometer setpoint or jog setpoint, externally via the PROFINET interface or an analog input of the customer terminal block. The internal fixed setpoint and the motorized potentiometer setpoint can be switched over or adjusted using control commands via all of the interfaces.
Ramp-function generator	A user-friendly ramp-function generator with separately adjustable ramp-up and ramp-down times, together with variable smoothing times in the lower and upper speed ranges, improves the control response and therefore prevents mechanical overloading of the drive train. The ramp-down ramps can be parameterized separately for emergency stop.

SINAMICS SM150 in the IGCT version	Description
Kinetic buffering	Power supply failures are bridged to the extent permitted by the kinetic energy of the drive train. The speed drops depending on the moment of inertia and the load torque. The current speed setpoint is resumed when the power supply returns. Kinetic buffering is not available when operating separately excited synchronous motors.
Automatic restart	The automatic restart switches the drive on again when the power is restored after a power failure or a general fault, and ramps up to the actual speed setpoint.
Flying restart	The flying restart function permits smooth connection of the converter to a rotating motor.
Diagnostic functions	<ul style="list-style-type: none"> • Self-diagnosis of control hardware • Non-volatile memory for reliable diagnostics when the power supply fails • Monitoring of HV IGBTs with individual messages for each mounting location • User-friendly on-site operator panel with plain text messages
Operating hours and switching cycles counter	The operating hours of the non-redundant fans, which are located on the roof section of the cabinets, are detected and logged so that preventive maintenance can be performed or equipment replaced as a preventive measure. The switching cycles of the circuit breaker are recorded and added together, to form the basis of preventive maintenance work.
Sensing the actual motor speed (option K50)	The Sensor Module SMC30 can be used to sense the actual motor speed. The signals from the rotary pulse encoder are converted here and made available for evaluation to the closed-loop controller via the DRIVE-CLiQ interface.
Operator protection	The cabinet doors of the power sections are fitted with electromagnetic locks. This prevents the cabinet doors being opened while hazardous voltages are connected inside the cabinet.
EMERGENCY OFF button	The converters are equipped as standard with an EMERGENCY OFF button with protective collar which is fitted in the cabinet door. The contacts of the button are connected in parallel to the terminal block so they can be integrated in a protection concept on the plant side. EMERGENCY OFF stop category 0 is set as standard for an uncontrolled shutdown (IEC 60204-1). The function includes voltage disconnection of the converter output through the circuit breaker. The motor coasts in the process. (The auxiliary power circuits are <i>not</i> disconnected.) Optionally available: Control of the "Safe Torque Off" function (option K80)
Insulation monitoring	The converters feature insulation monitoring of the complete electrical circuit from the secondary side of the transformer to the stator windings of the motor.
Monitoring the peripherals	An extensive package of options for I/O monitoring (from the transformer and the motor through to the auxiliaries) is available. In addition it is possible to monitor the temperature with thermocouples or Pt100 resistors.

SINAMICS SM150 in the IGCT version	Description
Thermal overload protection	<p>An alarm message is issued first when the overtemperature threshold is reached. If the temperature rises further, either a shutdown is carried out or automatic influencing of the output current so that a reduction in the thermal load is achieved. Following elimination of the cause of the fault (e.g. improvement in the ventilation), the original operating values are automatically resumed.</p> <p>For instance, for air-cooled converters and when filter mats are used, the amount of pollution of the filter mats is monitored by measuring the differential pressure which is then signaled. In the case of water-cooled converters, the water temperature and flow rate are recorded at several points in the cooling circuit and evaluated. An extensive self-diagnosis protects the converter and reports faults.</p>
Make-proof grounding switch (options L48, L49)	<p>If grounding on the infeed or motor side is required for safety and protection reasons, a motorized make-proof grounding switch can be ordered.</p> <p>For safety reasons, the converter controller locks these make-proof grounding switches against activation while voltage is still present. The control is integrated into the protection and monitoring chain of the converter. The make-proof grounding switches are inserted automatically when the standard make-proof grounding switches of the DC link are inserted.</p>

SIMATIC HMI TP900 Comfort operator panel

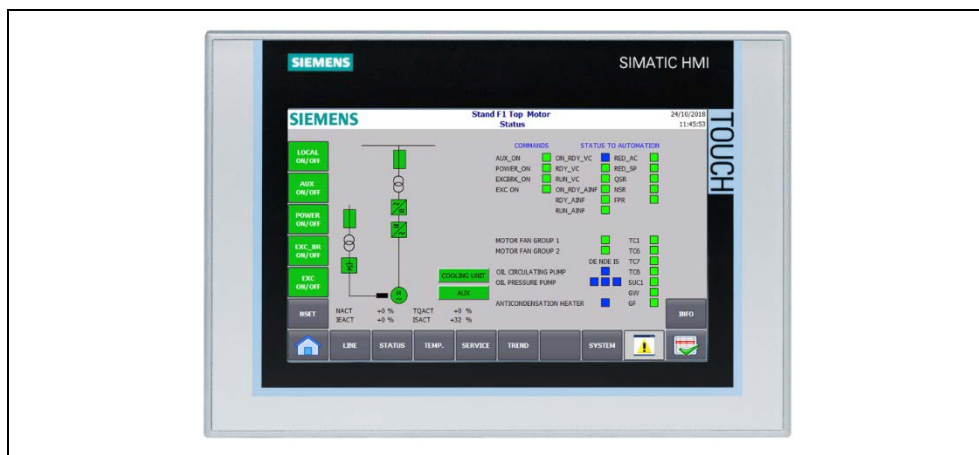

Fig. 5-9 SIMATIC HMI TP900 Comfort

The SIMATIC HMI TP900 Comfort operator panel with touch screen is integrated in the SINAMICS SM150 cabinet door, and is used for operating, monitoring and parameterizing.

It sets itself apart as a result of the following features.

Display	9.0" widescreen TFT display, 16 million colors
Resolution	800 x 480 px
Operator controls	Touch screen
Interfaces	USB port in the cabinet door (e. g. to download trace files)

5.5 Selection and ordering data

Type rating	Shaft output		Rated output current	SINAMICS SM150 in the IGCT version	Circuit version
kVA	kW	hp	A	Article No.	Fig. No.
3.3 kV output voltage					
10000	9600	13000	1750	6SL3845-7NN41-8AA3	11
20000	19200	26000	2 × 1750	6SL3845-7NN43-6AA3	12
30000	28800	39000	3 × 1750	6SL3845-7NN45-4AA3	13
10000 ¹⁾	9600	13000	2 × 1750	6SL3845-7NN41-8AB3	14
10000 ¹⁾	9600	13000	3 × 1750	6SL3845-7NN41-8AC3	15
10500	10200	13500	1850	6SL3845-7NN42-2AA3	11
21000	20400	27000	2 × 1850	6SL3845-7NN44-5AA3	12
31500	30600	40500	3 × 1850	6SL3845-7NN46-7AA3	13

1) The underlying circuits are based on a drive line-up in which the drives operate both as motor and generator. Energy is exchanged via the DC link. The specified power corresponds to the maximum infeed power. The effective total power of the Motor Modules (taking into account the power flow direction) may not exceed this infeed power. This information is provided with the coincidence factor stamped on the rating plate.

Note:

For other technical requirements that have to be taken into consideration (surge loads, operation at low frequencies, possibly necessary derating for parallel circuit configurations, limits regarding the maximum permissible short-circuit current) please contact your Siemens sales partner with the required specifications.

Note:

DC bus configurations with up to seven power sections are available on request (e.g. two Active Line Modules, five Motor Modules).

5.6 Technical specifications

5.6.1 General technical data

General technical data	
Power components	IGCTs
Line-side converter	Active Line Module: Regulated, self-commutating feed/feedback unit
Motor-side converter	Motor Module: Inverter
Closed-loop control	Vector control
Drive quadrants	4 (driving and braking per 2 directions of rotation)
Electrically isolated power section/open-loop and closed-loop control	Fiber optic cable, isolating transformer
Auxiliary power supply (for fans, coolant pumps, precharging the DC link capacitors, open-loop and closed-loop control)	230 V 1 AC $\pm 10\%$, 50/60 Hz $\pm 3\%$ and 400 V 3 AC $\pm 10\%$, 50/60 Hz $\pm 3\%$
Installation altitude	≤ 1000 m above sea level: 100 % load capability > 1000 ... 4000 m above sea level: current derating required > 2000 ... 4000 m above sea level: voltage derating required in addition
Insulation	According to 61800-5-1: Pollution degree 2 (without conductive pollution), condensation not permissible
Degree of protection	According to IEC 60529: IP43
Protection class	Protection class I acc. to IEC 61800-5-1
Shock-hazard protection	DIN EN 50274/VDE 0660 T514 and BGV A3 when used for the intended application
Interference emission	This drive unit is part of a PDS, Category C4 acc. to IEC 61800-3. It has not been designed to be connected to the public line supply. EMC disturbances can occur when connected to these line supplies. The essential requirements placed on EMC protection for the drive system should be secured using an EMC plan on the customer side.
Paint finish/color	Indoor requirements/RAL 7035, light gray

General technical data	
Applicable standards and directives <ul style="list-style-type: none"> • Standards 	IEC 61800-3 IEC 61800-5-1 And if referenced in the standards above: IEC 61800-2 IEC 60146-1-1 IEC 60204-11, however, structuring principles and reference marking according to IEC 61346-1 instead of IEC 81346-1
<ul style="list-style-type: none"> • EU directives 	2014/35/EU: Low Voltage Directive 2014/30/EU: Electromagnetic Compatibility
Conformity with other directives	EAC TR TC 020/2011 (electromagnetic compatibility) The converter rating plate has an EAC marking.
Water cooling	Water-water cooling unit, internal circuit, deionized water
Permissible coolant temperature (raw water) <ul style="list-style-type: none"> • Inlet • Discharge, max. 	+5 ... +35 °C ¹⁾ +40 °C ²⁾

1) With derating also higher values (see section 5.6.2); values lower than +5 °C on request

2) Higher values on request

Rated data	
Output voltage	3.3 kV
Input voltage	3.3 kV
Input voltage tolerance	±10 %
Line frequency	50/60 Hz ±5 %
Line power factor fundamental mode	1

Control-related properties	Operation of induction motors		Operation of separately excited synchronous motors
	Without speed encoder	With speed encoder	With speed encoder
Operating range			
Lower limit of speed control range (% of rated motor speed)	0 %	0 %	0 %
Max. permissible output frequency	250 Hz	250 Hz	90 Hz
Field weakening range	1:3	1:3	1:4
Steady-state operation			
Speed accuracy (% of rated motor speed)	±0.2 % (from 5 % of rated speed)	±0.01 %	±0.01 %
Torque accuracy (% of rated torque)	±5 % (from 5 % of rated speed)	±5 %	±2 %
Dynamic operation			
Torque rise time	5 ms	5 ms	5 ms

5.6 Technical specifications

	Storage	Transport	Operation
Climatic environmental conditions			
Ambient temperature	–25 ... +70 °C	–25 ... +70 °C	+5 ... +40 °C
Relative humidity	5 ... 95 % (only slight condensation permitted; converter must be completely dry before commissioning)	5 ... 95 % (only slight condensation permitted; converter must be completely dry before commissioning)	5 ... 85 % (condensation not permissible)
Other climatic conditions in accordance with Class	1K22 according to IEC 60721-3-1 (icing not permissible)	2K11 according to IEC 60721-3-2	3K22 according to IEC 60721-3-3
Degree of pollution	2 without conductive pollution according to IEC 61800-5-1	2 without conductive pollution according to IEC 61800-5-1	2 without conductive pollution according to IEC 61800-5-1
Mechanical environmental conditions			
in accordance with Class (increased strength for marine use)	1M11 according to IEC 60721-3-1	2M4 according to IEC 60721-3-2	3M11 according to IEC 60721-3-3
Other environmental conditions			
Biological environmental conditions in accordance with Class	1B1 according to IEC 60721-3-1	2B1 according to IEC 60721-3-2	3B1 according to IEC 60721-3-3 (without harmful flora)
Chemically active substances in accordance with Class	1C1 according to IEC 60721-3-1	2C1 according to IEC 60721-3-2	3C1 according to IEC 60721-3-3:1994 (no occurrence of salt mist)
Mechanically active substances in accordance with Class	1S11 according to IEC 60721-3-1	2S1 according to IEC 60721-3-2	3S6 according to IEC 60721-3-3

Note:

The values specified under storage and transport apply to suitably packed converters.

5.6.2 Derating for special installation conditions

Current derating

If the converters are operated at installation altitudes above 1000 m above sea level or with intake temperatures in the cooling unit $> 35\text{ °C}$, derating factors k_H or k_T must be taken into account for the rated output current (DIN 43671). The following applies for the permissible continuous current I :

$$I \leq I_N \times k_H \times k_T$$

I : permitted continuous current

I_N : rated current

The derating factors are shown in the following diagrams.

Note

The characteristics for installation altitudes up to 5000 m and higher raw water intake temperatures are available on request.

Current derating as a function of the installation altitude (water cooling)

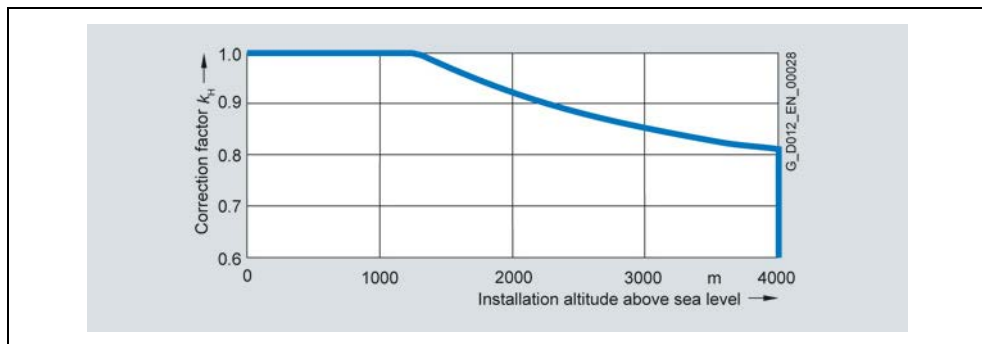

Fig. 5-10 Derating factor k_H for water cooling

Current derating as a function of the raw water intake temperature

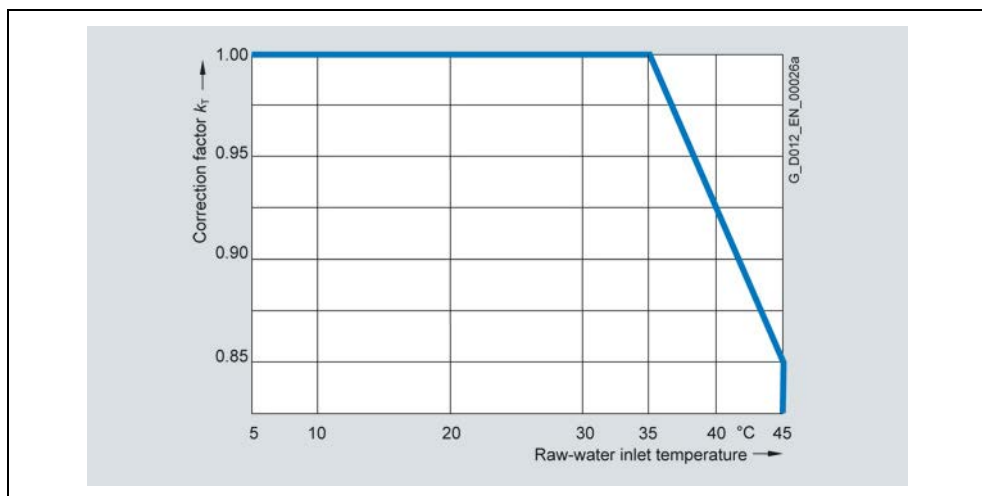

Fig. 5-11 Derating factor k_T (raw water intake temperature)

Voltage derating

For installation altitudes >2000 m, acc. to IEC 60664-1 in addition to a current derating, a voltage derating is also required. This depends on the air and creepage distances in the unit.

Voltage derating as a function of the installation altitude

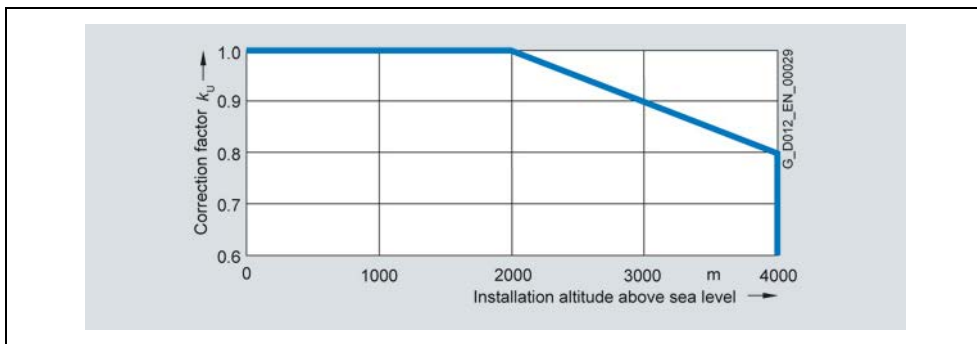

Fig. 5-12 Derating factor k_u

Example

Derating data SINAMICS SM150 in the IGCT version (water-cooled converter)

Drive unit	6SL3845-7NN41-8AA3
Output voltage	3.3 kV
Input voltage	3.3 kV
Type rating	10000 kVA, 1750 A
Installation altitude	2000 m
Raw water intake temperature	40 °C
k_H (water cooling)	0.925
k_T (raw water intake temperature)	0.925
k_U	1.0

For the current, the following applies:

$$I \leq I_N \times 0.925 \times 0.925 = I_N \times 0.856$$

A current derating of 14.4 % is required.

The maximum available output current is 1497 A.

5.6.3 Type-specific technical data

The type-specific technical data for SINAMICS SM150 converters in the IGCT version are listed in the following tables.

SINAMICS SM150 in the IGCT version Water cooling		Article number: 6SL3845-...					
		...7NN41-8AA3	...7NN43-6AA3	...7NN45-4AA3	...7NN41-8AB3	...7NN41-8AC3	
Output voltage 3.3 kV							
Type rating	kVA	10000	20000	30000	10000	10000	
Shaft output ¹⁾	kW	9600	19200	28800	9600 ²⁾	9600 ²⁾	
	hp	13000	26000	39000	13000 ²⁾	13000 ²⁾	
Rated output current	A	1750	2 × 1750	3 × 1750	2 × 1750	3 × 1750	
Input voltage	kV	3.3	2 × 3.3	3 × 3.3	3.3	3.3	
Rated input current ¹⁾	A	1770	2 × 1770	3 × 1770	1770	1770	
Power loss ^{3) 4)}	kW	100	200	300	150	225	
Efficiency ⁴⁾	%	99.0	99.0	98.9	99.3	99.2	
Typ. current demand of the auxiliary supply 230 V 1 AC 50/60 Hz ⁵⁾	A	18	36	54	28	38	
Max. current demand of the auxiliary supply 400 V 3 AC 50/60 Hz	A	6	12	18	9	12	
Precharging current demand, for approx. 25 s	A	20	40	60	22	24	
Raw water flow rate	l/min	333	667	1000	667	667	
Deionized water volume	l	50	100	150	75	100	
Sound pressure level L _{pA} (1m)	dB	75	77	79	76	77	
Measuring surface level L _s (1m)	dB	22	23	24	22.5	23	
Cable cross-sections, line-side, max. connectable per phase ^{6) 7)}	mm ² (DIN VDE)	4 × 240	4 × 240	4 × 240	4 × 240	4 × 240	
	AWG/MCM (NEC,CEC)	4 × 500 MCM	4 × 500 MCM	4 × 500 MCM	4 × 500 MCM	4 × 500 MCM	
Cable cross-sections, motor-side, max. connectable per phase ^{6) 7)}	mm ² (DIN VDE)	4 × 240	4 × 240	4 × 240	4 × 240	4 × 240	
	AWG/MCM (NEC,CEC)	4 × 500 MCM	4 × 500 MCM	4 × 500 MCM	4 × 500 MCM	4 × 500 MCM	
PE connection, max. cross-section at the enclosure with M12 screw ⁶⁾	mm ² (DIN VDE)	2 × 120	2 × 120	2 × 120	2 × 120	2 × 120	
	AWG/MCM (NEC,CEC)	2 × 250 MCM	2 × 250 MCM	2 × 250 MCM	2 × 250 MCM	2 × 250 MCM	
Degree of protection	–	IP43	IP43	IP43	IP43	IP43	
Dimensions ⁸⁾	Width	mm	5800	10700	15800	8400	10700
	Height ⁹⁾	mm	2540	2540	2540	2540	2540
	Depth	mm	1600	1600	1600	1600	1600
Circuit version	Fig. No.	11	12	13	14	15	
Weight ⁸⁾	kg	5850	11700	17550	8700	11550	

Note:

For other technical requirements that have to be taken into consideration (surge loads, operation at low frequencies, possibly necessary derating for parallel circuit configurations) please contact your Siemens sales partner with the required specifications. Additional DC bus configurations are available on request.

Note:

DC bus configurations with up to seven power sections are available on request (e.g. two Active Line Modules, five Motor Modules).

For footnotes, see Page 99.

5.6 Technical specifications

SINAMICS SM150 in the IGCT version Water cooling		Article number: 6SL3845-...		
		...7NN42-2AA3	...7NN44-5AA3	...7NN46-7AA3
Output voltage 3.3 kV				
Type rating	kVA	10500	21000	31500
Shaft output ¹⁾	kW	10200	20400	30600
	hp	13500	27000	40500
Rated output current	A	1850	2 × 1850	3 × 1850
Input voltage	kV	3.3	2 × 3.3	3 × 3.3
Rated input current ¹⁾	A	1870	2 × 1870	3 × 1870
Power loss ^{3) 4)}	kW	150	300	450
Efficiency ⁴⁾	%	98.6	98.6	98.6
Typ. current demand of the auxiliary supply 230 V 1 AC 50/60 Hz ⁵⁾	A	18	36	54
Max. current demand of the auxiliary supply 400 V 3 AC 50/60 Hz	A	6	12	18
Precharging current demand, briefly for approx. 25 s	A	20	40	60
Raw water flow rate	l/min	333	667	1000
Deionized water volume	l	50	100	150
Sound pressure level L _{pA} (1m)	dB	75	77	79
Measuring surface level L _s (1m)	dB	22	23	24
Cable cross-sections, line-side, max. connectable per phase ^{6) 7)}	mm ² (DIN VDE)	4 × 240	4 × 240	4 × 240
	AWG/MCM (NEC,CEC)	4 × 500 MCM	4 × 500 MCM	4 × 500 MCM
Cable cross-sections, motor-side, max. connectable per phase ^{6) 7)}	mm ² (DIN VDE)	4 × 240	4 × 240	4 × 240
	AWG/MCM (NEC,CEC)	4 × 500 MCM	4 × 500 MCM	4 × 500 MCM
PE connection, max. cross-section at the enclosure with M12 screw ⁶⁾	mm ² (DIN VDE)	2 × 120	2 × 120	2 × 120
	AWG/MCM (NEC,CEC)	2 × 250 MCM	2 × 250 MCM	2 × 250 MCM
Degree of protection	–	IP43	IP43	IP43
Dimensions ⁸⁾	Width	mm	5800	10700
	Height ⁹⁾	mm	2540	2540
	Depth	mm	1600	1600
Circuit version	Fig. No.	11	12	13
Weight ⁸⁾	kg	5850	11700	17550

Note:

For other technical requirements that have to be taken into consideration (surge loads, operation at low frequencies, possibly necessary derating for parallel circuit configurations) please contact your Siemens sales partner with the required specifications. Additional DC bus configurations are available on request.

Note:

DC bus configurations with up to seven power sections are available on request (e.g. two Active Line Modules, five Motor Modules).

For footnotes, see Page 99.

Footnotes for technical data, SINAMICS SM150 in the IGCT version, water cooled:

1) The data for the rated input current and the power data in hp and kW are approximate values only; these have been calculated for operation with synchronous motors for a motor power factor $\cos\phi_{typ} = 1$ and a motor efficiency of 96 %. The calculation is based on the rated output current. The rated input current also depends on the line power factor, for which a typical value of 1 was assumed.

The hp data are based on the NEC and CEC guidelines for the North American market. The kW values are specified in multiples of 500. Both approximate values need to be adapted to the motor which is actually used.

2) The underlying circuits are based on a drive line-up in which the drives operate both as motor and generator. Energy is exchanged via the DC link. The specified power corresponds to the maximum infeed power. The effective total power of the Motor Modules (taking into account the power flow direction) may not exceed this infeed power. This information is provided with the coincidence factor stamped on the rating plate.

3) Approx. 5 % of the power loss is dissipated in the room.

4) Without cooling system.

5) The typical current drawn (rms value);

$\cos\phi_{typ} = 0.6$) of the supply for the converter open-loop/closed-loop control is specified. The separate supplies for the socket outlets/light or switched auxiliary power feeders (options **N35 to N38**) have not been taken into account. Values for the typical current drawn for special configurations (e.g. for dimensioning an upstream UPS) are available on request.

When using options **L48** (make-proof grounding switch at the converter input), **L49** (make-proof grounding switch at the converter output) or **L51** (disconnector at the converter output), it should further be taken into account that for switching operations, additional peak values of up to 10 A can occur for each make-proof grounding switch or disconnecter. This corresponds to the starting current of a motor used to operate a switch, which decays from approx. 10 A to approx. 2 A in 200 ms. A switching operation takes a total time of approx. 2 s. All optionally used make-proof grounding switches or disconnectors are controlled via the manually actuated make-proof grounding switch for the converter DC link (standard) and therefore switch simultaneously!

6) Data refer to a sub-system; for details about the number of sub-systems to be connected on the line or motor side, see circuit versions.

7) The maximum permissible cable lengths should be carefully observed (see power cables 11.7).

8) The specified dimensions and weights include doors, panels and cooling unit, however no options.

9) Depending on the pressure equalization tank, the cooling unit can have a maximum cabinet height of 2900 mm.

6 SINAMICS SM150 IGCT version with diode infeed

6.1 Overview

The IGCT version of the SINAMICS SM150 converter, described in Chapter 5, is equipped with an Active Line Module that is capable of energy recovery.

Multi-motor drive version with diode infeed

For applications where energy recovery is not required, and several motors can be simultaneously operated, SINAMICS SM150 is also available in a water-cooled version with Basic Line Module.

Typical applications:

- Metal (e.g. rod mill, cold rolling mill)
- Mining (e.g. mills, conveyor belts with and without gear units)

6.2 Design

The well-proven design of the SINAMICS GM150 in the IGCT version is used as basis for the Basic Line Modules on the line side (see Chapter 3). As standard, these modules are equipped with a 12-pulse rectifier. A 24-pulse Basic Line Module is optionally available.

The Motor Modules correspond to those described in Chapter 5. Phase modules are used in these Motor Modules, in which IGCTs, diodes etc. are grouped together in one compact tensioned stack.

DC bus configuration for multi-motor drives

Up to three Motor Modules with three motors can be operated on the common DC bus where energy can be directly exchanged.

Note:

DC bus configurations with up to seven power sections are available on request (e.g. two Active Line Modules, five Motor Modules).

Cabinet design and circuits

The converter comprises cabinets for the Basic Line Modules and for the Motor Modules. One of three phase components and the control section in the Motor Module cabinet unit are highlighted in the diagram.

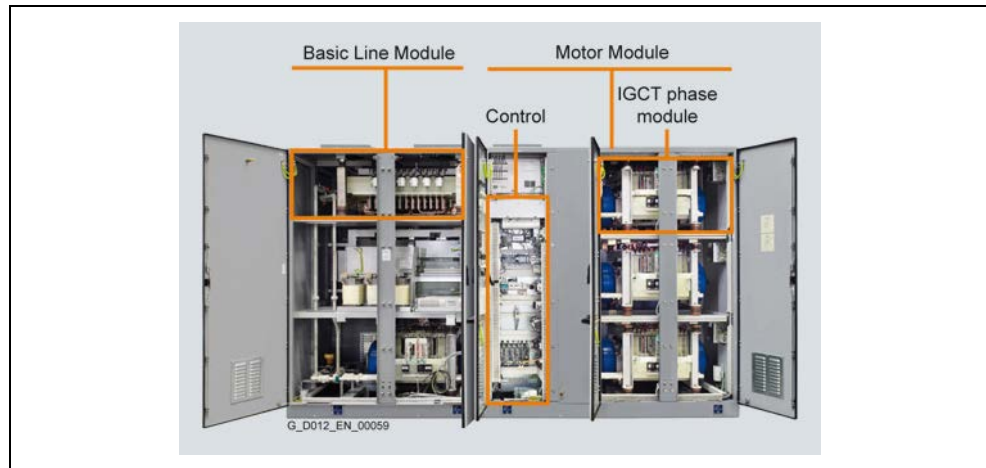

Fig. 6-1 SINAMICS SM150 in the IGCT version with diode infeed (principle design without cooling unit)

The following circuit versions are available for SINAMICS SM150 in the IGCT version with diode infeed.

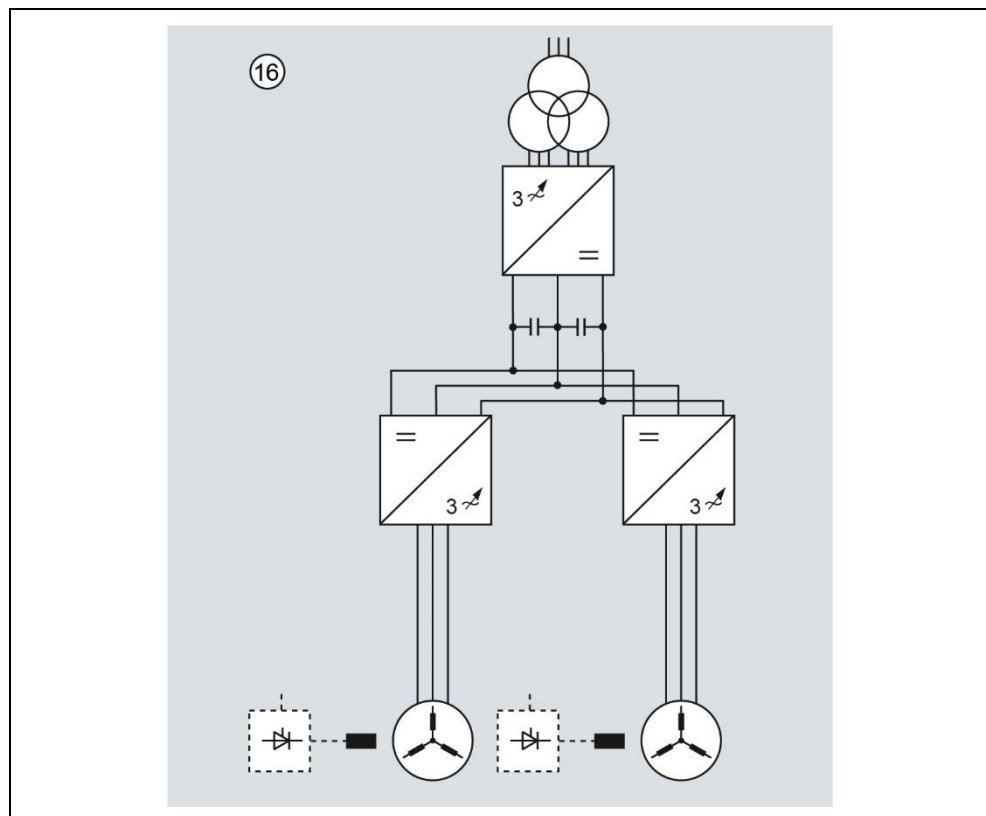

Fig. 6-2 DC bus configuration with two motors connected to a common DC link

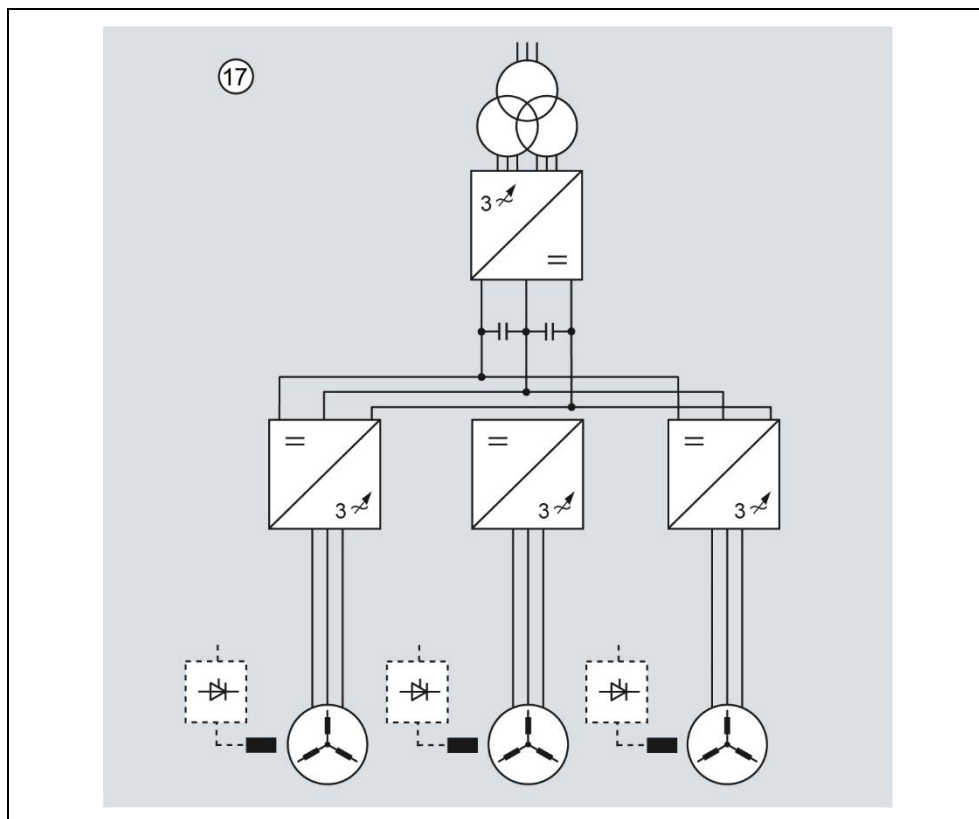

Fig. 6-3 DC bus configuration with three motors connected to a common DC link

Note:
 DC bus configurations with up to seven power sections are available on request (e.g. two Active Line Modules, five Motor Modules).

6.3 Selection and ordering data

Type rating	Shaft output		Rated output current	SINAMICS SM150 in IGCT version with diode infeed	Circuit version
kVA	kW	hp	A	Article No.	Fig. No. (see section 6.2)
Output voltage 3.3 kV					
10000 ¹⁾	9600	13000	2 × 1750	6SL3845-2NN41-8AB3	16 (1 BLM, 2 MM) ²⁾
10000 ¹⁾	9600	13000	3 × 1750	6SL3845-2NN41-8AC3	17 (1 BLM, 3 MM) ²⁾
On request				6SL3845-2NN42-2DB3	16 (1 BLM, 2 MM) ²⁾
On request				6SL3845-2NN42-2DC3	17 (1 BLM, 3 MM) ²⁾

1) The underlying circuits are based on a drive line-up in which the drives operate both as motor and generator. Energy is exchanged via the DC link. The specified power corresponds to the maximum infeed power. The effective total power of the Motor Modules (taking into account the power flow direction) may not exceed this infeed power.

2) The number of Basic Line Modules (BLM) and Motor Modules (MM) is specified in brackets.

7 Options

7.1 Overview

The following tables contain a complete overview of the availability of options for the four converter versions, SINAMICS GM150 and SINAMICS SM150 in the IGBT and IGCT versions.

Reference is made in the appropriate footnotes regarding the exceptions for SINAMICS SM150 in the IGCT version with diode infeed.

A detailed description of the options can be found in Chapter 7.2.

Note:

An option can only be ordered once per converter, if not explicitly specified otherwise.

Note:

The "on request" comment can have the following meanings:

- The price has not been defined and must be determined after an inquiry has been sent to the factory before a quotation can be generated.
- The option requires technical clarification and – depending on secondary technical conditions – may not be able to be realized for all types.

✓	Option that can be ordered
–	Option that cannot be ordered
On request	Option can be ordered on request

Order code	Option	SINAMICS GM150		SINAMICS SM150	
		IGBT	IGCT	IGBT	IGCT
A06	Terminal block extension	✓	✓	✓	✓
A70	Thermo switch for de-excitation resistor	Only for static excitation unit	Only for static excitation unit	Only for static excitation unit	Only for static excitation unit
B00	NAMUR terminal block	✓	✓	✓	✓
B07	System engineering for the converter	–	–	On request	On request
B43	Documentation, production flowchart: Generated once	✓	✓	✓	✓
B44	Documentation, production flowchart: Updated every two weeks	✓	✓	✓	✓
B45	Documentation, production flowchart: Updated every month	✓	✓	✓	✓
B49	Manufacturing Record Book	✓	✓	✓	✓
B55	Creation of preliminary and final packing list (shipping)	✓	✓	✓	✓
B56	Labeling of packing units with customer-specific label	✓	✓	✓	✓
B57	Photo documentation of the ordered units	✓	✓	✓	✓
C30	Auxiliary voltage 200 V 3 AC 50 Hz	✓	✓	✓	–
C33	Auxiliary voltage 220 V 3 AC 60 Hz	✓	✓	✓	–

Order code	Option	SINAMICS GM150		SINAMICS SM150	
		IGBT	IGCT	IGBT	IGCT
C34	Auxiliary voltage 230 V 3 AC 60 Hz	✓	✓	✓	–
C35	Auxiliary voltage 240 V 3 AC 60 Hz	✓	✓	✓	–
C36	Auxiliary voltage 380 V 3 AC 50 Hz	✓	✓	✓	–
C37	Auxiliary voltage 380 V 3 AC 60 Hz	✓	✓	✓	–
C38	Auxiliary voltage 400 V 3 AC 50 Hz	✓	✓	✓	–
C39	Auxiliary voltage 415 V 3 AC 50 Hz	✓	✓	✓	–
C40	Auxiliary voltage 440 V 3 AC 60 Hz	✓	✓	✓	–
C41	Auxiliary voltage 460 V 3 AC 60 Hz	✓	✓	✓	–
C42	Auxiliary voltage 480 V 3 AC 60 Hz	✓	✓	✓	–
C43	Auxiliary voltage 500 V 3 AC 50 Hz	✓	✓	✓	–
C44	Auxiliary voltage 550 V 3 AC 50 Hz	✓	✓	✓	–
C46	Auxiliary voltage 575 V 3 AC 60 Hz	✓	✓	✓	–
C48	Auxiliary voltage 690 V 3 AC 50 Hz	✓	✓	✓	–
C49	Auxiliary voltage 690 V 3 AC 60 Hz	✓	✓	✓	–
C55	Auxiliary voltage 120 V 1 AC for open-loop and closed-loop control	✓	✓	✓	–
C60	Rated line frequency 60 Hz	Only for static excitation unit	Only for static excitation unit	Only for static excitation unit	Only for static excitation unit
C68	SINAMICS CONNECT 500	Included as standard	Included as standard	Included as standard	Included as standard
D00	Documentation in German	✓	✓	✓	✓
D02	Circuit diagrams, terminal diagrams and dimension drawings in DXF format	✓	✓	✓	✓
D08	Preliminary interface documentation	✓	✓	✓	✓
D09	3D model in the STEP format	✓	✓	✓	✓
D15	One set of printed documentation	✓	✓	✓	✓
D54	Documentation in Czech	✓	✓	✓	✓
D55	Documentation in Polish	✓	✓	✓	✓
D56	Documentation in Russian	✓	✓	✓	✓
D57	Documentation in Japanese	✓	✓	✓	✓
D62	Documentation in Danish	✓	✓	✓	✓
D71	Documentation in Romanian	✓	✓	✓	✓
D72	Documentation in Italian	✓	✓	✓	✓
D73	Documentation in Finnish	✓	✓	✓	✓
D74	Documentation in Dutch	✓	✓	✓	✓
D75	Documentation in Turkish	✓	✓	✓	✓
D76	Documentation in English	✓	✓	✓	✓
D77	Documentation in French	✓	✓	✓	✓
D78	Documentation in Spanish	✓	✓	✓	✓
D79	Documentation in Portuguese	✓	✓	✓	✓
D80	Documentation in Bulgarian	✓	✓	✓	✓
D81	Documentation in Norwegian	✓	✓	✓	✓
D82	Documentation in Hungarian	✓	✓	✓	✓
D83	Documentation in Swedish	✓	✓	✓	✓
D84	Documentation in Chinese	✓	✓	✓	✓
D85	Documentation in Slovenian	✓	✓	✓	✓
D86	Documentation in Greek	✓	✓	✓	✓
D87	Documentation in Slovakian	✓	✓	✓	✓

Order code	Option	SINAMICS GM150		SINAMICS SM150	
		IGBT	IGCT	IGBT	IGCT
D88	Documentation in Estonian	✓	✓	✓	✓
D89	Documentation in Latvian	✓	✓	✓	✓
D90	Documentation in Lithuanian	✓	✓	✓	✓
D95	Documentation in Croatian	✓	✓	✓	✓
E00	Control for separately excited synchr. motors	✓	✓	✓	✓
E01	Control for separately excited synchronous motors with slip-ring excitation	On request	On request	✓	✓
E02	Control for separately excited synchronous motors with brushless rotating reverse-field excitation	On request	On request	On request	On request
E03	Control for permanently excited synchronous motors	On request	On request	On request	✓
E21	Suitable for marine use with individual certificate from Lloyds Register (LR)	Only for water cooling	✓	On request	On request
E31	Suitable for marine use with individual certificate from Bureau Veritas (BV)	Only for water cooling	✓	On request	On request
E41	Suitable for marine use with indiv. certificate from Registro Italiano Navale (RINA)	Only for water cooling	✓	On request	On request
E51	Suitable for marine use with individual certificate from Det Norske Veritas Germanischer Lloyd (DNV)	Only for water cooling	✓	On request	On request
E61	Suitable for marine use with indiv. certificate from American Bureau of Shipping (ABS)	Only for water cooling	✓	On request	On request
E71	Suitable for marine use with indiv. certificate from China Classification Society (CCS)	Only for water cooling	✓	On request	On request
E87	Electrically isolated analog outputs	✓	✓	✓	✓
F03	Visual acceptance, with the customer present	✓	✓	✓	✓
F72	Functional acceptance of converter with inductive load, without the customer present	✓	✓	✓	✓
F73	Functional acceptance of converter with inductive load, with the customer present	✓	✓	✓	✓
F76	Acceptance of the converter insulation test, without the customer present	✓	✓	✓	✓
F77	Acceptance of the converter insulation test, with the customer present	✓	✓	✓	✓
F79	Test of interface between the converter and customer equipment, with customer present	✓	✓	✓	✓
F97	Customer-specific system acceptance tests	On request	On request	On request	On request
G20	CAN bus interface (CANopen via CBC10)	✓	✓	–	–
G21	Modbus Plus interface	✓	On request	–	–
G22	Modbus RTU slave interface	✓	✓	–	–
G23	DeviceNet interface	✓	On request	–	–
G30	PROFIBUS master	Only for static excitation unit	Only for static excitation unit	–	–
G34	PROFINET interface (via CBE30)	–	–	On request	On request
G51	1xTM150 temperature sensor evaluation unit	✓	✓	✓	✓
G52	2xTM150 temperature sensor evaluation units	✓	✓	✓	✓
G53	3xTM150 temperature sensor evaluation units	✓	✓	✓	✓
G67	PROFINET bus monitor ibaBM-PN	–	–	–	✓
G70	Pulse distributor to transfer the speed encoder signal	On request	On request	✓	✓

Order code	Option	SINAMICS GM150		SINAMICS SM150	
		IGBT	IGCT	IGBT	IGCT
G71	Optical bus terminal (OBT) for PROFIBUS	On request	On request	✓	✓
K20	Indicator lights in the cabinet door	✓	✓	✓	✓
K21	Display instruments in the cabinet door for voltage, current, speed and power as well as indicator lights	✓	✓	✓	✓
K22	Display instruments in the cabinet door for current, speed, power and winding temperature as well as indicator lights	✓	✓	✓	✓
K50	Sensor Module Cabinet-Mounted SMC30	✓	✓	Included as standard	Included as standard
K66	Power section with internal cooling	Only for water cooling and on request	On request	Only for water cooling and on request	On request
K80	Control of "Safe Torque Off" function	✓	✓	✓	✓
K90	CU320-2 DP Control Unit (PROFIBUS)	✓	✓	–	–
L06	Internally generated 24 V DC	Only for static excitation unit	Only for static excitation unit	Only for static excitation unit	Only for static excitation unit
L08	Output reactor	✓	–	✓	–
L10	dv/dt filters	–	✓	On request	✓ ¹⁾
L21	Overvoltage protection AC	Only for static excitation unit	Only for static excitation unit	Only for static excitation unit	Only for static excitation unit
L32	Automatic restart	✓	✓	Included as standard (VSM10 and software functionality)	
L35	Redundant power section and control	On request	On request	–	–
L38	Redundant power section for parallel circuit configuration	On request	–	–	–
L48	Make-proof grounding switch at converter input	✓	✓	On request	✓
L49	Make-proof grounding switch at converter output	✓	✓	On request	✓
L50	Cabinet lighting and service socket in the control section	✓	✓	✓	✓
L51	Disconnecter at the converter output	✓	✓	✓	✓
L52	Circuit breaker at converter output	On request	✓	On request	✓
L53	UPS for the power supply of the open-loop and closed-loop control	✓	✓	–	–
L55	Anti-condensation heating for the cabinet	✓	✓	✓	✓
L60	EMERGENCY STOP, Stop Category 1	✓	✓	–	–
L72	Braking Module	✓	✓	On request	On request
L78	Output reactor with damping	On request	–	On request	–
L87	Rotor ground fault monitoring	Only for static excitation unit	Only for static excitation unit	Only for static excitation unit	Only for static excitation unit
L88	Ground fault monitoring with analog output	Only for static excitation unit	Only for static excitation unit	Only for static excitation unit	Only for static excitation unit
L95	Evaluation of 6 Pt100 or Pt1000 resistance thermometers for explosion protection	✓	✓	✓	✓
L96	Evaluation of 12 Pt100 or Pt1000 resistance thermometers for explosion protection	✓	✓	✓	✓
M10	Safety interlocking system	✓	✓	✓	✓

Order code	Option	SINAMICS GM150		SINAMICS SM150	
		IGBT	IGCT	IGBT	IGCT
M11	Dust protection	Only for air cooling	–	Only for air cooling	Included as standard
M13	Power cables at the converter input connected from the top	✓	–	–	On request
M16	Increased dust protection	Only for water cooling	–	–	–
M32	Customer terminal block with spring-loaded terminals for signal cables up to 2.5 mm ²	Included as standard	✓	Included as standard	✓
M33	Customer terminal block with screw terminals for signal cables up to 2.5 mm ²	✓	✓	✓	✓
M34	Connection of auxiliary voltage and signal cables from the top	✓	–	–	–
M36	Cable entry, brass for power cables	✓	✓	–	✓
M42	IP42 degree of protection	Only for air cooling	–	Only for air cooling	–
M44	IP44 degree of protection	Only for water cooling	✓ ¹⁾	–	✓
M54	IP54 degree of protection	Only for water cooling	✓ ¹⁾	–	✓
M61	Redundant fan in the power section	Only for air cooling	–	–	–
M64	Converter prepared for connection to an external air discharge system, with internal cabinet fans	Only for air cooling	–	–	–
M66	Suitable for marine use	Only for water cooling	✓	Only for water cooling	✓
M78	Power cables at the converter output connected from the top	✓	–	–	On request
N06	Capacitor Module to increase the DC link capacitance (1 module)	–	–	–	✓ ¹⁾
N07	Capacitor Modules to increase the DC link capacitance (2 modules)	–	–	–	✓ ¹⁾
N08	Capacitor Modules to increase the DC link capacitance (3 modules)	–	–	–	✓ ¹⁾
N13	Circuit breaker at the converter input	24-pulse on request only	Not for parallel circuit ¹⁾	–	On request
N15	24-pulse Basic Line Module	✓	✓	–	– ²⁾
N16	36-pulse Basic Line Module	✓	On request	–	–
N22	Input-side switch	Only for static excitation unit	Only for static excitation unit	Only for static excitation unit	Only for static excitation unit
N30	Controlled motor feeder for auxiliaries 400 V 3 AC/480 V 3 AC, max. 4/4.8 kW	✓	✓	✓	✓
N31	Controlled motor feeder for auxiliaries 400 V 3 AC/480 V 3 AC, max. 7/8 kW	✓	✓	✓	✓
N32	Controlled motor feeder for auxiliaries 400 V 3 AC/480 V 3 AC, max. 11/12.7 kW	✓	✓	✓	✓
N33	Controlled motor feeder for auxiliaries 400 V 3 AC/480 V 3 AC, max. 15/17.5 kW	✓	✓	✓	✓

Order code	Option	SINAMICS GM150		SINAMICS SM150	
		IGBT	IGCT	IGBT	IGCT
N35	Controlled outgoing feeder for auxiliaries 230 V 1 AC/120 V 1 AC max. 1.2/1 kW	✓	✓	✓	✓
N36	Controlled outgoing feeder for auxiliaries 230 V 1 AC/120 V 1 AC max. 2.2/1.5 kW	✓	✓	✓	✓
N37	Controlled outgoing feeder for auxiliaries 230 V 1 AC/120 V 1 AC, max. 3.5/2.1 kW	✓	✓	✓	✓
N38	Controlled outgoing feeder for auxiliaries 230 V 1 AC/120 V 1 AC max. 4.5/2.8 kW	✓	✓	✓	✓
Q80	Extension of the liability for defects period by 12 months to a total of 24 months (2 years) from delivery	✓	✓	✓	✓
Q81	Extension of the liability for defects period by 18 months to a total of 30 months (2.5 years) from delivery	✓	✓	✓	✓
Q82	Extension of the liability for defects period by 24 months to a total of 36 months (3 years) from delivery	✓	✓	✓	✓
Q83	Extension of the liability for defects period by 30 months to a total of 42 months (3.5 years) from delivery	✓	✓	✓	✓
Q84	Extension of the liability for defects period by 36 months to a total of 48 months (4 years) from delivery	✓	✓	✓	✓
Q85	Extension of the liability for defects period by 48 months to a total of 60 months (5 years) from delivery	✓	✓	✓	✓
Q86	Extension of the liability for defects period by 24 months to a total of 36 months (3 years) from delivery, with SIDRIVE IQ	✓	✓	✓	✓
Q87	Extension of the liability for defects period by 36 months to a total of 48 months (4 years) from delivery, with SIDRIVE IQ	✓	✓	✓	✓
Q88	Extension of the liability for defects period by 48 months to a total of 60 months (5 years) from delivery, with SIDRIVE IQ	✓	✓	✓	✓
T58	Rating plate in English/French	✓	✓	✓	✓
T60	Rating plate in English/Spanish	✓	✓	✓	✓
T80	Rating plate in English/Italian	✓	✓	✓	✓
T82	Rating plate in English/Portuguese	On request	On request	On request	On request
T85	Rating plate in English/Russian	On request	On request	On request	On request
T86	Rating plate in English/Polish	On request	On request	On request	On request
T90	Rating plate in English/Japanese	On request	On request	On request	On request
T91	Rating plate in English/Chinese	On request	On request	On request	On request
U01	UL listing	-	-	-	On request
U03	CSA conformity	On request	On request	On request	On request
W02	Cooling unit with redundant stainless steel plate-type heat exchangers	Only for water cooling	✓	Only for water cooling	✓
W11	Cooling unit with titanium plate-type heat exchanger	Only for water cooling	✓	Only for water cooling	✓
W12	Cooling unit with redundant titanium plate-type heat exchangers	Only for water cooling	✓	Only for water cooling	✓
W14	Converter without cooling unit, provided on the plant side	Only for water cooling	✓	Only for water cooling	✓
W20	Raw-water connection from the bottom	Only for water cooling	Included as standard	-	Included as standard

Order code	Option	SINAMICS GM150		SINAMICS SM150	
		IGBT	IGCT	IGBT	IGCT
W90	Converter without phase module	–	–	–	On request
Y05	Customer-specific rating plate	✓	✓	✓	✓
Y09	Special paint finish according to RAL ...	✓	✓	✓	✓
Y10	Circuit diagrams with customer-specific text field	✓	✓	✓	✓
Y15	Sine-wave filter	On request	–	On request	–
Y17	Line reactor	Only for static excitation unit	Only for static excitation unit	–	Only for static excitation unit
Y26	Premagnetization unit	On request	On request	–	–
Y35	Customer-specific cabinet labeling	–	–	–	✓
Y40	Raw water data that deviates from the catalog data	Only for water cooling, on request	On request	Only for water cooling, on request	On request
Y73	Braking resistor	✓	✓	On request	On request

- 1) Only on request for SINAMICS SM150 in the IGCT version with diode infeed.
2) Available for SINAMICS SM150 in the IGCT version with diode infeed.

7.2 Description of the options

To enable the required description to be found more easily, the following option descriptions are sorted alphabetically by order codes. If an option is not available for all converter versions, then this is indicated in brackets after the option title.

A06

Terminal block extension

With option A06, the number of control and status signals available via terminal blocks is expanded using one additional TM31 Terminal Module and one additional TM15 Terminal Module.

TM31 Terminal Modules:

- 8 digital inputs
- 4 bidirectional digital inputs/outputs
- 2 relay outputs with changeover contact
- 2 analog inputs
- 2 analog outputs
- 1 temperature sensor input for KTY84-130, Pt1000 or PTC
- 2 DRIVE-CLiQ sockets

TM15 Terminal Modules:

- 24 bidirectional digital inputs/outputs
(potential isolation in 3 groups, each with 8 channels)
- 24 green status LEDs
to display the logical signal state of the particular terminal
- 2 DRIVE-CLiQ sockets

For additional information on the Terminal Modules, see SINAMICS system components in one of the Catalogs D 21.3 or D 21.4.

Note:

For isolated analog outputs, option **E87** is available.

A70

Thermostatic switch for the de-excitation resistor (only for static excitation unit)

With option **A70** the de-excitation resistor is equipped with an additional thermo switch, and monitored by a SICROWBAR overvoltage protection device.

When the de-excitation resistor is overloaded, the SICROWBAR overvoltage protection initiates the E-STOP function (power is disconnected) in the excitation converter.

B00
NAMUR terminal block

The terminal block has been configured in accordance with the requirements and guidelines of the Standards Working Group for Instrumentation and Control in the Chemical Industry (NAMUR Recommendation NE37), i.e. fixed terminals are assigned to certain functions of the devices. The inputs and outputs assigned to the terminals comply with "Protective extra-low voltage PELV" requirements.

For temperature monitoring of explosion-protected motors, options for PTC thermistors with PTB approval and Pt100 evaluation units for use in hazardous areas are available.

This terminal block and the associated functions are reduced to the required amount. Contrary to the NAMUR recommendation, no additional terminals are included.

If Pt100 resistance thermometers are integrated in the motor windings to protect explosion-protected motors, then these thermometers can be evaluated using options **L95** and **L96**.

If a force-ventilated motor is used due to the application (load torque/control range), controlled outgoing feeders – protected using motor circuit breakers – are available with options **N30 to N33** to supply an external fan. The incoming voltage supply for the external fan must be provided on the plant side.

Options **N35 to N38** include a controlled and fused external voltage outgoing feeder for the anti-condensation heating in the motor.

B07
System engineering for the converter (for SINAMICS SM150 on request; not available for SINAMICS GM150)

With option **B07**, application-specific engineering is made available for SINAMICS SM150. Based on this engineering work, the converter can be integrated into the system environment. Important drive parameters are preset.

B43 to B45
Production flowcharts

Production flowcharts are provided with options **B43 to B45**. After the order has been clarified, these are sent as dual language (English/German) PDF file by E-Mail.

Option	Description
B43	Documentation, production flowchart: Generated once
B44	Documentation, production flowchart: Updated every two weeks
B45	Documentation, production flowchart: Updated every month

7.2 Description of the options

Option combination exclusions		B43	B44	B45
Documentation, production flowchart: Generated once	B43		-	-
Documentation, production flowchart: Updated every two weeks	B44	-		-
Documentation, production flowchart: Updated every month	B45	-	-	

-	Options cannot be combined
---	----------------------------

B49**Manufacturing Record Book**

With option **B49**, a printed "Manufacturing Record Book" is provided with the following content:

- Test certificates for the converter and its main components
- Factory certification (scope, type test, standards)
- Manufacturer routing slip

This document verifies that all quality assurance measures were performed during production. This document is not part of the documentation and is provided separately.

For more information please contact your Siemens sales partner.

B55 to B57**Logistic options**

Option	Description
B55	Creation of preliminary and final packing list (shipment)
B56	Labeling of packing units with customer-specific label
B57	Photo documentation of ordered units

C30 to C49**Auxiliary voltage other than N/400 V/3 AC
(not available for SINAMICS SM150 in the IGCT version)**

An N/400 V/3 AC auxiliary supply must be provided on the plant side to supply power for the fans, open-loop/closed-loop control, protection and monitoring systems as well as the DC link precharging. If the auxiliary supply in the plant differs from this value, you must select one of the options **C30** to **C49**. In this case the three-phase infeed supply which differs from the standard version is adapted with three individual transformers to the required voltage level. Tappings from 200 V 3 AC to 690 V 3 AC are available for this purpose. The current required for the auxiliary infeed supply can be determined from the data for the current requirement at 400 V 3 AC (see Technical Data, Conversion to Existing Auxiliary Voltage).

Order codes for auxiliary voltages and line frequencies	
C30	200 V 3 AC 50 Hz
C33	220 V 3 AC 60 Hz
C34	230 V 3 AC 60 Hz
C35	240 V 3 AC 60 Hz
C36	380 V 3 AC 50 Hz
C37	380 V 3 AC 60 Hz
C38	400 V 3 AC 50 Hz
C39	415 V 3 AC 50 Hz
C40	440 V 3 AC 60 Hz
C41	460 V 3 AC 60 Hz
C42	480 V 3 AC 60 Hz
C43	500 V 3 AC 50 Hz
C44	550 V 3 AC 50 Hz
C46	575 V 3 AC 60 Hz
C48	690 V 3 AC 50 Hz
C49	690 V 3 AC 60 Hz

Note:

A matching transformer is necessary if 400 V 3 AC 50 Hz is available on the plant side, however, without a neutral conductor connection. In this case, option **C38** should be selected. Exception: A separate 230 V supply can be provided for the closed-loop control on the plant side.

Note:

For isolated line systems the maximum supply voltage is 500 V 3 AC.

Note:

Access to the matching transformers is possible only from the rear of the converter.

C55**120 V 1 AC auxiliary voltage for open-loop and closed-loop control (not available for SINAMICS SM150 in the IGCT version)**

The open-loop control of the converter can be supplied with 120 V 1 AC with option **C55**.

Note:

The following options are available in conjunction with option **C55** on special request:

- **L48** and **L49** (make-proof grounding switch at converter input and output)
- **L51** (disconnecter at converter output)
- **L52** (circuit breaker at converter output)
- **N13** (circuit breaker at converter input)

C60**Rated line frequency 60 Hz (only for static excitation unit)**

Option **C60** must be selected if the line frequency of the armature and auxiliary circuits is 60 Hz instead of the 50 Hz. The device fan circuit breaker is appropriately adapted.

C68**SINAMICS CONNECT 500 (included as standard)**

Using SIDRIVE IQ, the relevant data of the drive systems can be easily accessed at any time and from anywhere, to be digitally monitored, analyzed and optimized. As a consequence, the status and operating data of the drive components are transparent; maintenance requirements and optimization potential can be identified.

To use SIDRIVE IQ, MV converters and HV motors must be equipped with the SINAMICS CONNECT 500 or SIMOTICS CONNECT 600 connectivity modules.

For SINAMICS GM150, in the standard version, the matching SINAMICS CONNECT 500 connectivity is integrated in the closed-loop control section via the already preselected option C68. Important operating parameters of the closed-loop converter control – for example that indicate the state, the temperature, the load and the status messages – are transferred to the SIDRIVE IQ digital platform for analysis via a secure, encrypted data link.

SINAMICS CONNECT 500 provides the basis ("IQ Ready"), to establish a link with the SIDRIVE IQ digital platform to be able to utilize the many associated advantages!

With the Starter Service Agreement the subscription and digital services are bundled to provide the customer with cloud-based alerts and direct support for rapid troubleshooting – available 24 hours a day, 7 days a week with a response time of only 1 to 2.5 hours.

SIDRIVE IQ Starter Services	Article number
SINAMICS GM150/SM150 Starter Service Agreement first year within warranty	9LD4110-1ES11-1AA1

Note:

Digitalization packages with a validity period of at least three years also automatically extend the liability for defects period for the converter by the same time (also see description of options **Q86** to **Q88**).

Additional information on SIDRIVE IQ is provided in the Internet at www.siemens.com/sidrive-iq.

Note:

Options **M66** (marine use) and **E21** to **E71** (individual certification) cannot be combined with option **C68**.

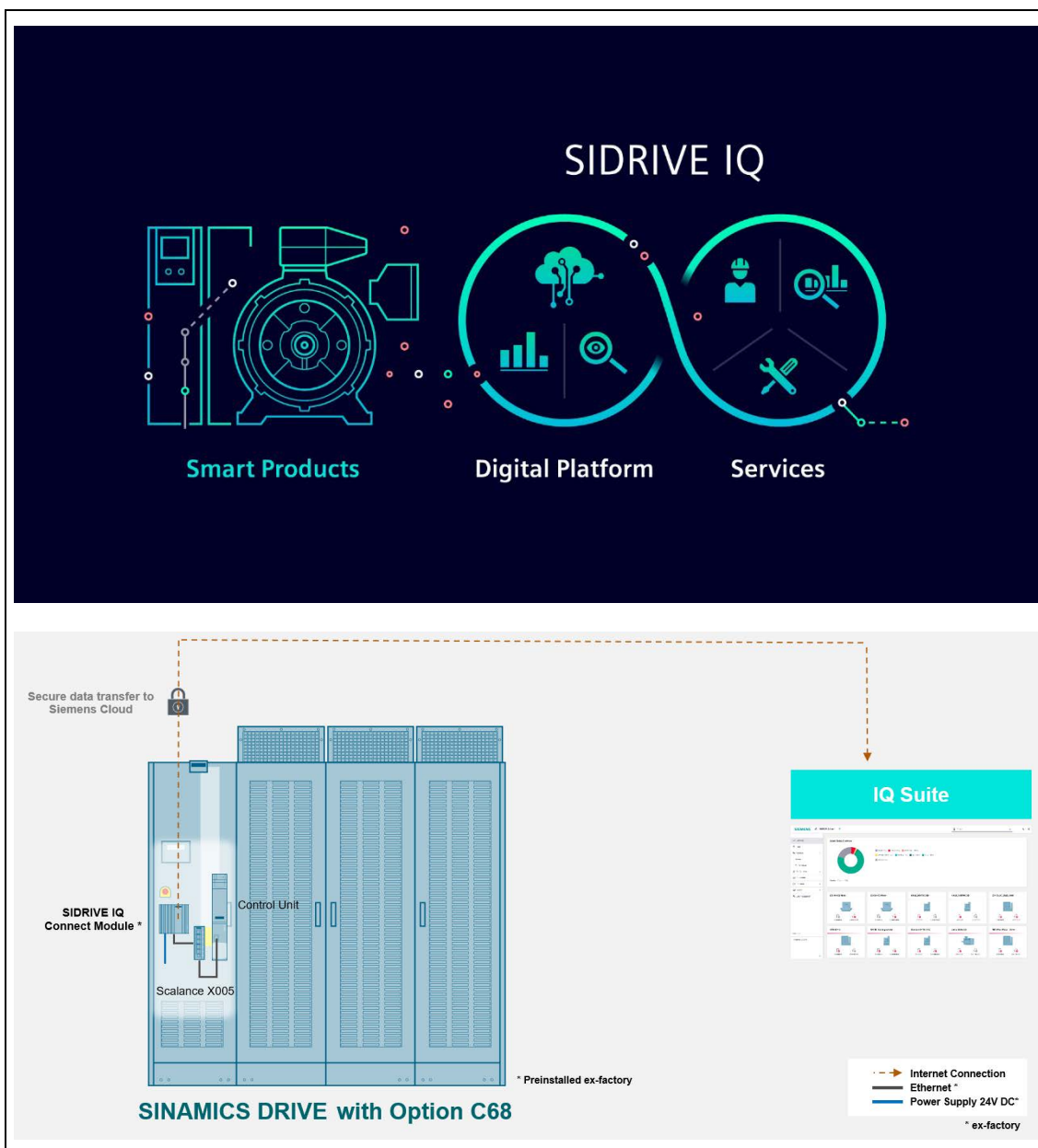

Fig. 7-1 Positioning in the SIDRIVE IQ system landscape

**D00 to D95
Documentation**

With option **D00** or one of the options **D54 to D95**, the operating instructions, the safety instructions and the warning labels on the converter are supplied in the relevant language.

Note:

This option must be selected if the end user is located in a EU country or in Turkey (D75 for Turkey).

The quality documents (e.g. acceptance reports, certificates etc.) and the technical documents (e.g. circuit diagrams, dimension drawings etc.) are only available in English or German.

7.2 Description of the options

Option	Description
D00	Documentation in German Documentation in German is available for download by specifying order code D00.
D02	Circuit diagrams, terminal diagrams and dimension drawings in DXF format Documents such as circuit diagrams, terminal diagrams, the arrangement diagram and the dimension drawing with the code D02 are ordered in the DXF format so that they can be processed in AutoCAD systems, for instance.
D15	One set of printed documentation (multiple orders possible) If paper documentation is also required, this must be ordered using the code D15.
D54	Documentation in Czech
D55	Documentation in Polish
D56	Documentation in Russian
D57	Documentation in Japanese
D62	Documentation in Danish
D71	Documentation in Romanian
D72	Documentation in Italian
D73	Documentation in Finnish
D74	Documentation in Dutch
D75	Documentation in Turkish
D76	Documentation in English If a documentation language other than English is selected using options D00 or D55 to D95, then by specifying order code D76, an additional documentation in English as second documentation language can be ordered. <u>Note:</u> When simultaneously selecting option D15 (a set of printed documentation) the printed documentation is only supplied in the first documentation language.
D77	Documentation in French
D78	Documentation in Spanish
D79	Documentation in Portuguese (Brazil)
D80	Documentation in Bulgarian
D81	Documentation in Norwegian
D82	Documentation in Hungarian
D83	Documentation in Swedish
D84	Documentation in Chinese
D85	Documentation in Slovenian
D86	Documentation in Greek
D87	Documentation in Slovakian
D88	Documentation in Estonian
D89	Documentation in Latvian
D90	Documentation in Lithuanian
D95	Documentation in Croatian

Option combination exclusions

Options **D00**, **D54 to D75** and **D77 to D95** mutually exclude one another; however, by ordering option **D76**, can be combined as second documentation language.

D08**Preliminary interface documentation**

With option **D08**, four weeks after clarifying the order checklist in the factory, the customer receives a package of documents relating to the control interfaces and drive integration.

The documents supplied encompass:

- Dimension drawings
- System-specific data sheet
- Circuit diagram

These documents are available for download in the standard factory format (PDF).

If changes are to be made to the documents, then at the latest two weeks after the documents become available, the factory must receive a change request, otherwise the confirmed delivery date must be adapted.

Additional costs can be incurred depending on the type of changes.

The factory will make changes to the document within two weeks after receiving the change request.

Note:

This option does not result in a holding point in the order administration. The delivery time of four weeks only refers to standard converters, and the options described in this document.

For customized options, the time required to prepare the documentation can be extended by between two and four weeks (dependent on the scope).

D09**3D model in the STEP format**

With option D09, a 3D model of the converter in the STEP format is provided for download (metric system). The model shows the empty converter cabinet with connection rails and water connection, but without the cooling unit.

7.2 Description of the options

E00**Control for separately excited synchronous motors (static excitation unit is provided on the plant side)**

If the converter is used to control separately excited synchronous motors, and the excitation equipment is provided on the plant side, then this must be taken into account when ordering by specifying order code **E00**.

Option combination exclusions		E00	E01	E02	E03
Control for separately excited synchronous motors	E00		-	-	-
Control for separately excited synchr. motors with slip-ring excitation	E01	-		-	-
Control for separately excited synchr. motors with brushless excitation	E02	-	-		-
Control for permanently excited synchronous motors	E03	-	-	-	

-	Options cannot be combined
---	----------------------------

E01**Control for separately excited synchronous motors with slip-ring excitation (SINAMICS GM150 only on request)**

If the converter is to be used to control separately excited synchronous motors with slipring excitation, then order code **E01** must be specified when ordering. For slip-ring excitation, the exciter cabinet must also be ordered by specifying its own Article number.

Note:

For exclusions with other options, see description of option **E00**.

E02**Control for separately excited synchronous motors with brushless reverse field excitation (for all versions, only on request)**

If the converter is to be used to control separately excited synchronous motors with brushless excitation, order code E02 must be specified when ordering. For brushless excitation, the exciter cabinet must also be ordered by specifying its own Article number.

Note:

For exclusions with other options, see description of option **E00**.

E03**Control for permanent-magnet synchronous motors (for SINAMICS SM150 in the IGBT version and SINAMICS GM150 only on request)**

If the converter is to be used to control permanently excited synchronous motors, then order code **E03** must be specified when ordering.

Note:

Option **E03** requires that option **L52** is simultaneously ordered (circuit breaker at converter output).

Note:

For exclusions with other options, see description of option **E00**.

E21 to E71

Individual certification of the converter by the relevant certifying organizations, including the expansions described under option M66 (only for water-cooled converters; for SINAMICS SM150 only on request)

Option	Description
E21	Suitable for marine use with individual certificate from Lloyds Register (LR) ¹⁾
E31	Suitable for marine use with individual certificate from Bureau Veritas (BV) ¹⁾
E41	Suitable for marine use with individual certificate from Registro Italiano Navale (RINA) ¹⁾
E51	Suitable for marine use with individual certificate from Det Norske Veritas (DNV) ¹⁾
E61	Suitable for marine use with individual certificate from the American Bureau of Shipping (ABS) ¹⁾
E71	Suitable for marine use with individual certificate from China Classification Society (CCS) ¹⁾

1) Includes option M66

E87**Electrically isolated analog outputs**

When option **E87** is selected, two electrically isolated analog outputs are available. Multirange transformers are always used.
Setting range: 0 V to 10 V; 0 mA to 20 mA or 4 mA to 20 mA

F03, F73, F77, F79, F97**Converter acceptance tests with the customer present**

Option	Description
F03	<p>Visual acceptance</p> <p>The checks are carried out with the converter deenergized. The following is included in the scope of the acceptance tests:</p> <ul style="list-style-type: none"> • Check of degree of protection • Check of equipment (components) • Check of equipment identifier • Check of clearance and creepage distances • Check of cables • Check of customer documentation • Submitting the acceptance report
F73	<p>Functional acceptance of converter with inductive load ¹⁾</p> <p>After the visual inspection with the converter off, the converter is connected to rated voltage. Rated current flows in an inductive load at an output frequency of 5 Hz (without connector motor) on the converter output side. The following is included in the scope of the acceptance tests:</p> <ul style="list-style-type: none"> • Visual inspection as described for option F03 • Check of power supply • Check of protective and monitoring devices (simulation) • The fan is checked (for water cooling: cooling circuit elements in the converter) • Precharging test • Functional test with inductive load at rated voltage and rated current • Submitting the acceptance report
F77	<p>Acceptance of the converter insulation test ¹⁾</p> <p>The following is included in the scope of the acceptance tests:</p> <ul style="list-style-type: none"> • High-voltage test • Measurement of insulation resistance <p>Option F77 can only be ordered in conjunction with options F73.</p>

7.2 Description of the options

Option	Description
F79	<p>Test of the interface between the converter and customer equipment (5 hours) ¹⁾</p> <p>The analog, digital and serial interfaces are tested according to their preassignment described in Chapter 8. For additional test requirements, option F97 must be selected.</p> <p>Option F79 can only be ordered in conjunction with option F73.</p>
F97	<p>Customer-specific system acceptance tests (on request)</p> <p>Before a system acceptance test, transformer (if necessary), converter, cooling system (if necessary) and motor should be mounted, installed and commissioned. Converter, cooling system and transformer are mounted directly next to each other, but separately from the motor.</p> <p>Only already pre-tested components (together with a test certificate) are subject to a system test.</p> <p>The tests that can be performed in the System Test Center are listed in the following. For each system acceptance test, the actual test scope must first be coordinated with the Siemens contact person.</p> <p><u>Temperature-rise test</u></p> <p>Full load test run or partial load test run of the motor in converter operation until the temperature reaches a steady-state.</p> <p>The operating point should preferably be selected where the highest temperature increase is to be expected (MN, nN). The resistance method is the basis for determining the temperature rise. During the temperature-rise test, in addition to the motor temperatures, the electrical operating parameters of the complete drive system are also continuously recorded.</p> <p><u>Load tests</u></p> <ul style="list-style-type: none"> • Load points at four different operating points • The system efficiency is determined at the defined load points • Line-side harmonics analysis <p><u>Additional tests</u></p> <ul style="list-style-type: none"> • High-voltage insulation test: <p>The converter and motor have already been tested as part of the routine tests performed during production. Re-testing the converter is time-consuming and is not recommended. It can only be performed as part of a test that is separately performed for options F73/F77.</p> <ul style="list-style-type: none"> • Converter function test: <p>The fault and alarm functions are checked using defined simulation routines (e.g. overtemperature trip, EMERGENCY STOP, overcurrent, overspeed, undervoltage)</p> <ul style="list-style-type: none"> • 120 % overspeed test • Noise measurement (motor fed from the converter without load) • Vibration measurement (motor fed from the converter without load) • Visual inspection (converter and motor and where relevant, transformer)

1) As a result of the local situation and the dimensions of the converter, the acceptance is always performed using a basic unit comprising a Line Module and a Motor Module.

Note:

An acceptance test of static excitation units according to options **F03**, **F73** and **F77** is only possible together with the converter which must be ordered simultaneously.

In general, a high voltage test of the converter is already performed during the type test. When the test is repeated as part of option **F77**, the test voltage is reduced to 80 % (according to IEC 61800-5-1).

Static excitation units are only accepted as part of option **F97** when this option is simultaneously selected for the converter and static excitation unit, and is generally performed at another location and at another time.

Option combination exclusions		F03	F73	F77	F79	F97
Visual acceptance	F03		-	-	-	-
Functional acceptance of converter with inductive load	F73	-		✓	✓	-
Acceptance of insulation test of the converter	F77	-	✓		✓	-
Test of the interface between the converter and customer equipment	F79	-	✓	✓		-
Customer-specific system acceptance tests	F97	-	-	-	-	

✓	Options can be combined
-	Options cannot be combined

F72, F76 Converter acceptance tests without the customer present

The acceptance scope of these options corresponds to that of options **F73** or **F77** – however, without the customer being present.

G20 to G23, K90, G34 Access to bus systems

The standard version of the SINAMICS GM150 has an integrated CU320-2 PN Control Unit with a PROFINET interface (slave).

The standard version of the SINAMICS SM150 includes a master-capable SIMOTION D Control Unit, which has a PROFIBUS as well as also a PROFINET interface.

Additional interface modules are optionally available.

Option	Description
For SINAMICS GM150	
G20	CAN bus interface (CANopen via CBC10)
G21	Modbus Plus interface (for IGCT version on request)
G22	Modbus RTU slave interface
G23	DeviceNet interface (for IGCT version on request)
K90	CU320-2 DP Control Unit (PROFIBUS)
For SINAMICS SM150 (on request)	
G34	PROFINET interface (via CBE30)

The "Anybus X-gateway" from the HMS Industrial Networks company is used to connect to third-party Modbus Plus systems (option **G21**), Modbus RTU (option **G22**) and DeviceNet (option **G23**).

When one of the options **G21**, **G22**, **G23** is selected, the Anybus X-gateway is installed when the equipment is delivered and is connected to the Control Unit via a PROFIBUS cable. The scope of supply includes a null modem cable to configure the Anybus X-gateway. The Anybus X-gateway is preconfigured to 20 bytes of I/O data. The data size can be changed via the configuration interface from a PG/PC (standard PC tool "Windows Hyper Terminal").

7.2 Description of the options

The "NetTool" from company HMS Industrial Networks should be used to configure PROFIBUS. This is not included in the scope of supply.

Current information, documentation and tools for Anybus-X-Gateway are available at www.anybus.com

Note:

When one of the options G21, G22, G23 is selected, then option K90 (Control Unit CU320-2 DP (PROFIBUS)) must also be simultaneously ordered.

Option combination exclusions for SINAMICS GM150		G20	G21	G22	G23	G71
CAN bus interface (CANopen via CBC10)	G20		-	-	-	-
Modbus Plus interface	G21	-		-	-	-
Modbus RTU slave interface	G22	-	-		-	-
DeviceNet interface	G23	-	-	-		-
Optical bus terminal (OBT) for PROFIBUS	G71	-	-	-	-	

-	Options cannot be combined
---	----------------------------

G30**PROFIBUS master (only for SINAMICS GM150 with static excitation unit)**

SINAMICS GM150 converters can communicate as standard only as PROFIBUS slaves. Therefore, in conjunction with a SINAMICS GM150 converter, a SIMATIC S7 controller with PROFIBUS master capability is used in the static excitation unit.

G51 to G53**TM150 Terminal Module temperature sensor evaluation units**

Options **G51** to **G53** can be used to order one to three TM150 Terminal Modules for sensing and evaluating several temperature sensors.

Order code	Option
G51	1 x TM150 temperature sensor evaluation unit
G52	2 x TM150 temperature sensor evaluation units
G53	3 x TM150 temperature sensor evaluation units

The TM150 Terminal Module is a DRIVE-CLiQ component for temperature evaluation. The temperature is measured in a temperature range from -99 °C to +250 °C for the following temperature sensors:

- Pt100 (with monitoring for wire breakage and short-circuit)
- Pt1000 (with monitoring for wire breakage and short-circuit)
- KTY84 (with monitoring for wire breaks and short-circuits)
- PTC (with monitoring for short-circuits)
- Bimetallic NC contact (without monitoring)

For the temperature sensor inputs, for each terminal block the evaluation can be parameterized for 4-wire. There is no electrical isolation in the TM150 Terminal Module.

Design

The following are located on the TM150 Terminal Module:

- 6 to 12 temperature sensor inputs
- 2 DRIVE-CLiQ sockets

The status of the TM150 Terminal Module is indicated via a multi-color LED.

For additional information on the TM150 Terminal Module, see the SINAMICS system components in one of the catalogs D 21.3 or D 21.4.

Option combination exclusions		G51	G52	G53
1 x TM150 temperature sensor evaluation unit	G51		-	-
2 x TM150 temperature sensor evaluation units	G52	-		-
3 x TM150 temperature sensor evaluation units	G53	-	-	

-	Options cannot be combined
---	----------------------------

**G67
ibaBM-PN PROFINET bus monitor (only for SINAMICS SM150 in IGCT version)**

The ibaBM-PN PROFINET bus monitor allows drive-related variables to be read and recorded via PROFINET. The recorded data can be processed and used for diagnostics. The typical data acquisition clock cycle of all channels is between 1 and 2 ms, which means that fast signal characteristics can be simultaneously acquired and diagnosed.

The acquired values are transferred to an evaluation system (e.g. a notebook) via PROFINET.

**G70
Pulse distributor to transfer the speed encoder signal
(for SINAMICS GM150, only on request)**

With this pulse distributor it is possible to split the encoder signal. This possibility is used, for example, when speed list values from an HTL incremental encoder are required at various points for measured-value acquisition and processing.

The pulse distributor transfers the HTL incremental encoder signals to two separate RS-422 signal outputs. The inputs are electrically isolated from the outputs.

8-pole terminal blocks are used for the connection.

7.2 Description of the options

Note:

For SINAMICS GM150, option **K50** (Sensor Module Cabinet-Mounted SMC30) should be ordered at the same time.

G71**Optical bus terminal (OBT) for PROFIBUS
(for SINAMICS GM150, only on request)**

PROFIBUS OBT is a network component for use in optical PROFIBUS DP fieldbus networks. The individual bus stations are linked using two-phase plastic fiber optic cables. These automatically provide isolation and prevent potential differences in large plants from having any impact.

The OBT has three interfaces: Channel 1 is an electrical RS-485 interface in the form of a 9-pin Sub-D socket, which provides the connection to the converter control system. Channels 2 and 3 are the optical interface. They are configured as a duplex socket and can be used for connection on the plant side to higher-level systems.

Option combination exclusions for SINAMICS GM150		G20	G21	G22	G23	G71
CAN bus interface (CANopen via CBC10)	G20		-	-	-	-
Modbus Plus interface	G21	-		-	-	-
Modbus RTU slave interface	G22	-	-		-	-
DeviceNet interface	G23	-	-	-		-
Optical bus terminal (OBT) for PROFIBUS	G71	-	-	-	-	

-	Options cannot be combined
---	----------------------------

K20**Indicator lights in the cabinet door**

With option **K20**, five indicator lights that signal the operating status of the converter are provided in the cabinet door of the control section.

- Fault (red)
- Warning (yellow)
- Operation (green)
- Drive ready (white)
- Local operation (white)

Option combination exclusions		K20	K21	K22
Indicator lights in the cabinet door	K20		-	-
Display instruments in the cabinet door for voltage, current, speed and power as well as indicator lights	K21	-		-
Display instruments in the cabinet door for current, speed, power and winding temperature as well as indicator lights	K22	-	-	

-	Options cannot be combined
---	----------------------------

K21**Display instruments in the cabinet door for voltage, current, speed and power as well as indicator lights**

To enable process variables to be displayed, analog display instruments that show the measurement parameter as a % are located in the cabinet door.

- Motor current (0 to +120 %)
- Motor speed (–120 % ... 0 ... +120 %)
- Calculated motor power (0 to +120 %)
- Motor voltage (0 to +120 %).

Note:

Option **K21** includes option **K20**.

For exclusions with other options, see description of option **K20**.

K22**Display instruments in the cabinet door for current, speed, power and winding temperature as well as indicator lights**

To enable process variables to be displayed, analog display instruments that show the measurement parameter as a % are located in the cabinet door. The motor winding temperature is displayed as an absolute value in °C.

- Motor current (0 to +120 %)
- Motor speed (–120 % ... 0 ... +120 %)
- Calculated motor power (0 to +120 %)
- Motor winding temperature (0 to 200 °C)

Note:

Option **K22** includes option **K20**.

For exclusions with other options, see description of option **K20**.

K50**Sensor Module Cabinet-Mounted SMC30
(option for SINAMICS GM150, standard for SINAMICS SM150)**

The Sensor Module SMC30 can be used to sense the actual motor speed. The signals from the rotary pulse encoder are converted here and made available to the closed-loop control for evaluation via the DRIVE-CLiQ interface.

The following encoders are supported by the SMC30:

- TTL encoders
- HTL encoders

K66

Power section with internal cooling (only for water cooling; on request)

With option **K66**, the power sections can be operated without feeding in external cooling air. They have internal air circulation with an air-to-water heat exchanger and are implemented without ventilation slots.

Option **K66** reduces the ingress of damaging environmental effects in operation to a harmless level. An overview of the relevant environmental effects is provided in the following list:

- Heat
- Chemicals (soot and sulfur)
- Humidity
- Pollutants (conductive dusts)

Note:

- Within the scope of the environmental effects specified in the catalog, the environmental influences listed above are not harmful. However, option **K66** must be selected for the converter if the limit values corresponding to the corresponding environmental classes are exceeded.
- During storage and transport, option **K66** does not provide any protection against damaging environmental effects.
- Selecting option **K66** increases the degree of protection up to IP44.
- With option **K66**, the deionized water requirement of the cooling unit is higher than specified in the technical data.
- Option **K66**, the following modified environmental conditions in operation change when compared to standard values:
 - Ambient temperature:
 - 0 °C to +50 °C (without derating)
 - 0 °C to +55 °C (with derating)
 - Relative humidity: 5 % to 95 %
- With option **K66**, the dimensions for the SINAMICS SM150 in the IGCT version change as follows:
 - Overall height with mounted roof section: 2950 mm
 - Wooden pallet: 150 mm
 - Transportation altitude: 3100 mm

Option combination exclusions		K66	L10	M61	Y26
Power section with internal cooling	K66		-	-	-
dv/dt filter	L10	-		-	-
Redundant fan in the power section	M61	-	-		-
Premagnetization unit	Y26	-	-	-	

-	Options cannot be combined
---	----------------------------

K80**Control of "Safe Torque Off" function**

The "Safe Torque Off" function is a mechanism for preventing the drive from unexpectedly starting according to EN 60204-1:2006/A1:2009, Section 5.4. The safety-related STO function is integrated in the drive and is independent of the converter operating functions.

The function is used in conjunction with a machine function – or in the case of a fault – to disconnect the torque-generating energy feed to the motor in a safety-related fashion.

There are two independent switch-off signal paths, which are both failsafe (low-active). This ensures that when a component fails or a cable is interrupted, the system always goes into the safe state.

The following points apply when the STO function is selected:

- The motor cannot inadvertently start.
- The torque-generating energy feed to the motor is safely interrupted as a result of the safety-related pulse cancellation. Then the gating commands of the power semiconductors are safely inhibited. Without further engineering, the motor coasts down (see picture below).
- Motor Modules and motor are not electrically disconnected.

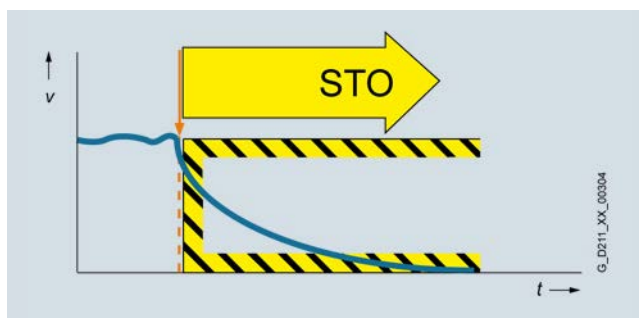

The "Safe Torque Off" function is certified in accordance with EN ISO 13849-1:2015 with Safety Category 3 and Performance Level e (Cat 3, PL e) as well as IEC 61508-5-1:2010 with Safety Integrity Level SIL 3 for the following components used in SINAMICS GM150 and SINAMICS SM150 converters:

- Power Stack Adapter PSA SINAMICS XM/XL 4
- SIRIUS 3SK1 safety relays

With the Power Stack Adapter and the safety relay, the STO function is prepared for use in the converter. With connecting additional external components (mushroom pushbutton or safety-related PLC), the STO function must be completed at the customer's site depending on the specific configuration.

Notice:

If customers carry out the expansions after the unit has been delivered, the customers are responsible for ensuring the functionality of STO.

7.2 Description of the options

More information about the EC type test certification for the Power Stack Adapter and the safety relay is available in the Internet at:

www.siemens.com/sinamics-sm150-k80

<https://support.industry.siemens.com/cs/ww/en/view/67835431>

Please also note the comparison of options **K80** and **L60** (see description of option **L60**) and further information about the STO function in the "Safe Torque Off for Medium-Voltage Drives" function manual:

<https://www.lda-portal.siemens.com/siemlda/en/11021>

Note:

For installation altitudes exceeding 2000 m, an inquiry is required when considering operation with option **K80**.

K90

CU320-2 DP Control Unit (PROFIBUS) (only for SINAMICS GM150)

With option K90, the converter is equipped with a CU320-2 DP (PROFIBUS) Control Unit. (CU320-2 PN (PROFINET) is provided as standard.)

L06

Internally generated 24 V DC (only for the static excitation unit)

Option **L06** includes generating a 24 V DC supply from the auxiliary voltage 230 V 1 AC 50/60 Hz using a switched-mode power supply.

L08

Output reactor (only for IGBT versions)

The output reactor is used to limit the capacitive charge-reversal currents of motor cables and is located in an additional cabinet unit.

The assumptions on which the cable lengths in the following table are based can be found under "Permissible cable lengths" in section 11.7.

Maximum cable lengths without and with output reactor or dv/dt filter:

Converter output voltage	Maximum cable length ¹⁾		
SINAMICS GM150 IGBT version and SINAMICS SM150 IGBT version			
	<u>Without output reactor (standard)</u>	<u>With output reactor (option L08)</u>	<u>With output reactor with damping (option L78) ³⁾</u>
2.3 kV	1 or 2 parallel cables: 100 m each 3 parallel cables: 80 m each	1 or 2 parallel cables: 1000 m each 3 or 4 parallel cables: 600 m each	Up to 4 parallel cables: 1000 m each
3.3 kV	4 parallel cables: 80 m each	1 or 2 parallel cables: 575 m each 3 or 4 parallel cables: 350 m each	Up to 4 parallel cables: 1000 m each
4.16 kV		1 or 2 parallel cables: 350 m each 3 parallel cables: 225 m each 4 parallel cables: 150 m each	1 or 2 parallel cables: 1000 m each 3 or 4 parallel cables: 350 m each
SINAMICS GM150 IGCT version and SINAMICS SM150 IGCT version			
	<u>Without dv/dt filter (standard)</u>	<u>With dv/dt filter (option L10) ²⁾</u>	–
3.3 kV	Up to 2 parallel cables: 100 m each 3 parallel cables: 80 m each 4 parallel cables: 80 m each	200 m each (greater lengths on request)	–

1) Distance converter-motor depending on the current load for max. of four shielded three-conductor cables connected in parallel. Mechanically, up to six parallel cables are possible (on request).

2) **L10** option description see below.

3) **L78** option on request only; for plant/system-specific solutions, please also contact your Siemens sales partner.

Notice:

When using an output reactor, the following values apply for the maximum output frequency:

- SINAMICS GM150 in the IGBT version and SINAMICS SM150 in the IGBT version: 150 Hz

Notice:

With option **L08**, the cabinet width is increased as follows:

- SINAMICS GM150 in the IGBT version and SINAMICS SM150 in the IGBT version:
 - Single circuit configuration: 600 mm
 - Parallel circuit configuration: 2 × 600 mm

7.2 Description of the options

Option combination exclusions		L08	L78	Y15
Output reactor	L08		-	-
Output reactor with damping	L78	-		-
Sine-wave filter	Y15	-	-	

-	Options cannot be combined
---	----------------------------

L10**dv/dt filter (for SINAMICS GM150 in IGBT version *not* available; for SINAMICS SM150 in IGCT version with diode infeed and in IGBT version only on request)**

The converter generates pulses at its output, which have a negative impact on the motor insulation. The dv/dt filter limits the rate of voltage rise at the converter output to a maximum of $1 \text{ kV}/\mu\text{s}$, and simultaneously restricts the capacitive charge/discharge currents in the motor cables.

The dv/dt filter is water-cooled and integrated into the Motor Module (see following diagram).

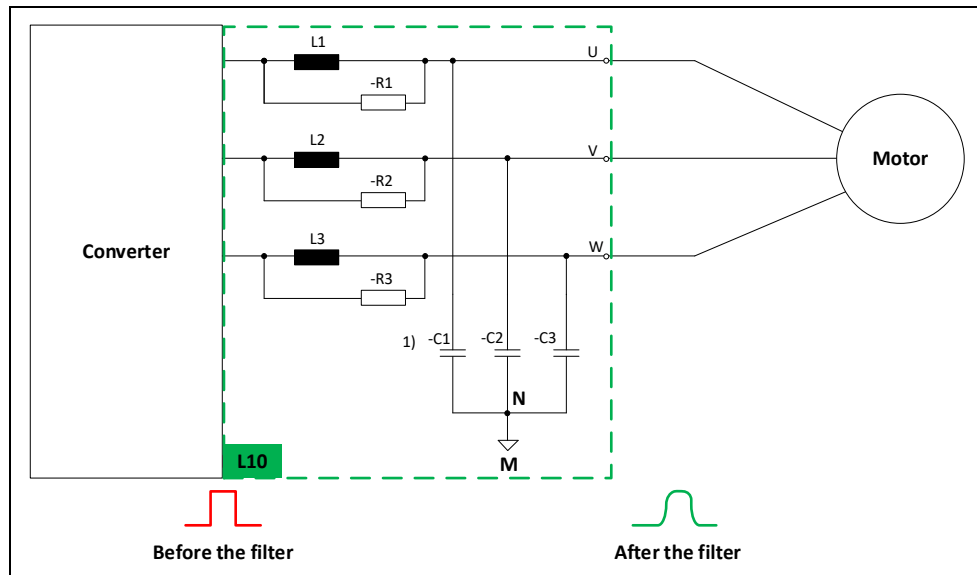

Fig. 7-2 Block diagram for Option **L10**
(N: Filter neutral point; M: Converter mid-point)

Note:

The following restrictions apply when using option **L10**:

- The converter pulse frequency must not exceed 200 Hz
- The deionized water requirement of the cooling unit is higher than specified in the technical data.
- The power loss is increased by approx. 30 kW.
- The output currents must be limited according to the following table.
- For SINAMICS SM150 in IGCT version, the cabinet depth increases by 120 mm.
- Maximum cable lengths, see overview table in option description **L08**.

Article number	Rated output current without L10 [A]	Rated output current with L10 [A]
SINAMICS GM150 in the IGCT version		
6SL3835-2LN41-8AA3	1750	1680
6SL3835-2LN42-1AA3	2100	2030
6SL3835-2LN42-3AA3	2 x 1360	2 x 1360
6SL3835-2LN42-8AA3	2 x 1360	2 x 1360
6SL3835-2LN43-6AA3	2 x 1570	2 x 1570
6SL3835-2LN44-2AA3	3 x 1220	3 x 1220
SINAMICS SM150 in the IGCT version		
6SL3845-7NN41-8AA3	1750	1680
6SL3845-7NN43-6AA3	2 x 1750	2 x 1680
6SL3845-7NN45-4AA3	3 x 1750	3 x 1680
6SL3845-7NN41-8AB3	2 x 1750	2 x 1680
6SL3845-7NN41-8AC3	3 x 1750	3 x 1680
6SL3845-7NN42-2AA3	1850	1780
6SL3845-7NN44-5AA3	2 x 1850	2 x 1780
6SL3845-7NN46-7AA3	3 x 1850	3 x 1780

L21**Overvoltage protection AC (only for static excitation unit)**

Option **L21** provides a SICROWBAR integrated overvoltage protection device on the input side.

L32**Automatic restart (option for SINAMICS GM150, standard for SINAMICS SM150)**

Option **L32** enables the converter to be restarted after a power failure.

The Voltage Sensing Module VSM10 included in the option must be connected to an external voltage measurement using a minimum of two voltage transformers (PTs) on the line side of the circuit breaker.

Note:

The automatic restart only functions if the 230V 1 AC electronics power supply is buffered using an UPS unit.

A distinction is made between the following three cases:

1. Hot standby

If the line supply is interrupted, the motor-side inverter pulses are inhibited as soon as the DC link voltage falls below the pulse inhibit threshold. However, the line-side circuit breaker remains closed. During a power interruption, the DC link voltage is supported by the pre-charging equipment. The VSM10 identifies when the line voltage returns, the pulses are enabled again and the motor resumes normal operation after a "flying restart".

In order to ensure that the hot standby also functions for line failures > 1 s, the auxiliary 400 V 3 AC supplies for the pre-charging equipment, for the cooling system pumps or the main fans for air-cooled converters must also be buffered using an UPS.

2. Automatic restart after power failure

If the DC link voltage falls below the threshold to open the line-side circuit breaker when the line supply is interrupted, then the circuit breaker is opened. The VSM10 identifies when the line supply returns, the faults resulting from the power failure are acknowledged – and the converter is again precharged and switched-on.

3. Automatic restart after any fault

If the automatic restart function is set to "Restart after any fault", then all faults after the circuit breaker has been opened are automatically acknowledged. The converter is then pre-charged again and switched on.

In all three cases, a parameterizable time limit must be maintained, otherwise the system is shut down with fault. Further, when the drive is released again, a signal is issued that can be used to generate an acoustic warning.

Note:

For SINAMICS SM150 in the IGBT and IGCT versions, the Voltage Sensing Module VSM10 as well as the software functionality is included as standard.

L35**Redundant power section and control**

(available on request for SINAMICS GM150 in the IGBT and IGCT versions)

Option **L35** can be selected for applications with very high demands relating to the availability. The probability of failure is significantly reduced as a result of the redundant converter design.

With option **L35**, the power section as well as the closed-loop control are duplicated to create a redundant solution.

When a power section fails, it is automatically disconnected at the line side and motor side. After a few seconds, the motor continues to operate with just one winding system and 50 % of the power.

When a DRIVE-CLiQ component fails (e.g. Control Unit, Terminal Module) the Control Unit active up until now and its DRIVE-CLiQ components can be manually deselected, and the second Control Unit (previously in the standby mode), selected. Between 60 and 90 seconds is required for the switchover, as the second Control Unit must first power up. The motor can then be operated with 100 % of its power.

Note:

- Option **L35** is only available to operate a motor equipped with two winding systems.
- Option **L35** requires that at least option **L51** (disconnecter at the converter output) is additionally ordered for induction motors and separately excited synchronous motors or **L52** (circuit breaker at the converter output) for permanently excited synchronous motors.

More detailed information is available on request.

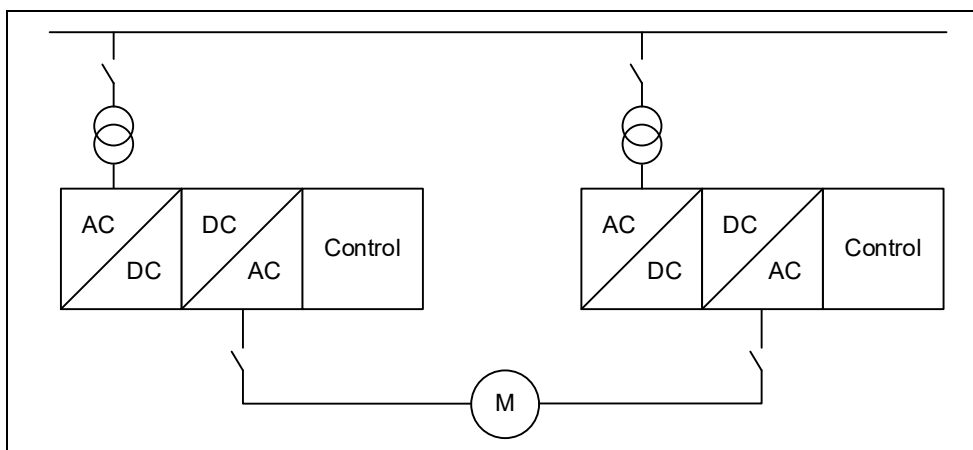

Fig. 7-3 Option L35: Redundant power section and control

L38**Redundant power section for parallel circuit configuration
(available on request for SINAMICS GM150 in the IGBT version)**

For a parallel configuration, option **L38** can be selected for applications with high demands relating to the availability.

With option L38, the power section is duplicated to create a redundant solution. When a power section fails, the motor can continue to operate with just one winding system and 50 % of the power.

The motor must be disconnected from the power section at the locations provided, and the insulation monitoring switched over.

When additionally ordering options **L51** (disconnecter at the converter output) for induction motors and separately excited synchronous motors or **L52** (circuit breaker at the converter output) for permanently excited synchronous motors, the failed power section is automatically disconnected from the motor side. The required additional cabinet is connected via cables.

Note:

- Option **L35** is only available to operate a motor equipped with two winding systems.
- Option **L38** cannot be combined with the following options:
 - **K66** (power section with internal cooling)
 - **L48** (make-proof grounding switch at the converter input)

Notice:

With option **L38**, the cabinet width is increased by 300 mm when compared to the standard version.

More detailed information is available on request.

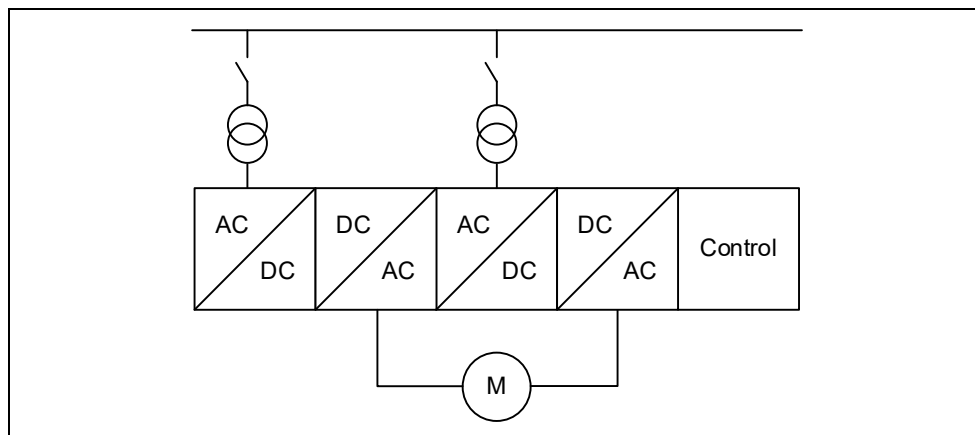

Fig. 7-4 Option L38: Redundant power section for parallel circuit configuration

L48

Make-proof grounding switch at the converter input, motor-operated (for SINAMICS SM150 in the IGBT version on request only)

If grounding on the infeed side is required for safety and protection reasons, a motorized make-proof grounding switch can be ordered under code **L48**. The number of make-proof grounding switches depends on the particular infeed version (12/24-pulse for SINAMICS GM150 or 6-pulse for SINAMICS SM150).

For safety reasons, the converter controller locks these make-proof grounding switches against activation while voltage is still present. The control is integrated into the protection and monitoring chain of the converter. The make-proof grounding switches are inserted automatically when the standard make-proof grounding switches of the DC link are inserted.

In the event of maintenance work on the converter, it must be ensured on the plant side that there is no external voltage present, e.g. auxiliary voltage for fans, the cooling system, controller and closed-loop control and any external outputs in the converter.

Notice:

With option **L48** the cabinet width is increased as follows:

- SINAMICS GM150 in the IGBT version: 600 mm
When option **L49** is simultaneously selected, the width does not have to be further increased.
- SINAMICS GM150 in the IGCT version: 2 x 700 mm per converter unit
- SINAMICS SM150 in the IGCT version: 700 mm for each converter unit

Note:

Option **L48** in conjunction with option **C55** (auxiliary power supply for open-loop and closed-loop control) on request.

Note:

For SINAMICS GM150 in the IGCT version, option **L48** in conjunction with option **N16** (36-pulse Basic Line Module) on request.

L49**Make-proof grounding switch at the converter output, motor-operated (for SINAMICS SM150 in the IGBT version on request only)**

In certain operating modes/versions of the load machine (e.g. drive line-up with gas turbines) and types of drive motor (e.g. PEM), operating statuses may occur in which there is a risk that energy is fed back to the converter by the motor. This can lead to dangerous voltages. In these cases a motorized make-proof grounding switch for the converter output side can be ordered under code **L49**. Where power sections are connected in parallel, the number of circuit breakers will rise accordingly.

For safety reasons, the converter controller locks the make-proof grounding switch against activation while voltage is still present. The control is integrated into the protection and monitoring chain of the converter. The make-proof grounding switches are inserted automatically when the standard make-proof grounding switches of the DC link are inserted.

Notice:

With option **L49** the cabinet width is increased as follows:

- SINAMICS GM150 in the IGBT version: 600 mm
When one of the options **L48**, **L51** or **L52** is simultaneously selected, the width does not have to be increased.
- SINAMICS GM150 in the IGCT version and
SINAMICS SM150 in the IGCT version: 700 mm for each converter unit
When option **L51/L52** is simultaneously selected, the width does not have to be further increased.

Note:

Option **L49** in conjunction with option **C55** (auxiliary power supply for open-loop and closed-loop control) on request.

L50**Cabinet lighting and service socket in the control section**

If option **L50** is selected, a universal lamp and a service socket (Schuko version) are installed in the cabinet panels of the control sections for Motor Modules and Active Line Modules.

An external power supply is used for the cabinet lighting and service socket outlet. The cabinet lighting is switched on manually via a switch or automatically by an integrated motion detector. The mode is switch-selected.

L51**Disconnecter at the converter output**

If isolation between the converter output and the drive motor is required for safety and protection reasons, a motorized disconnecter at the converter output can be ordered with option **L51**.

7.2 Description of the options

Notice:

The cabinet width increases as follows due to the additional cabinet at the converter:

- SINAMICS GM150 in the IGBT version and SINAMICS SM150 in the IGBT version: 600 mm
When option **L49** is simultaneously selected, the width does not have to be increased.
- SINAMICS GM150 in the IGCT version and SINAMICS SM150 in the IGCT version: 700 mm for each converter unit
When option **L49** is simultaneously selected, the width does not have to be increased.

Note:

Option **L51** in conjunction with option **C55** (auxiliary power supply for open-loop and closed-loop control) on request.

Option combination exclusions		L51	L52
Disconnecter at the converter output	L51		–
Circuit breaker at converter output	L52	–	

–	Options cannot be combined
---	----------------------------

L52**Circuit breaker at the converter output (for IGBT versions only on request)**

If isolation between the converter output and the drive motor is required for safety and protection reasons, a circuit breaker at the converter output can be ordered with option **L52**. This circuit breaker is triggered from the converter controller. On an ON command, the circuit breaker on the output side is connected together with the auxiliaries. The circuit breaker is switched off with the OFF command.

Note:

Option **L52** is mandatory in conjunction with permanent-magnet synchronous motors. However, a separate inquiry is required for this option, as several variable secondary conditions must be taken into account.

Note:

Option **L52** in conjunction with option **C55** (auxiliary power supply for open-loop and closed-loop control) on request.

Notice:

With option **L52** the cabinet width is increased as follows:

- SINAMICS GM150 in the IGBT version and SINAMICS SM150 in the IGBT version: 600 mm
When option **L49** is simultaneously selected, the width does not have to be increased.
- SINAMICS GM150 in the IGCT version and SINAMICS SM150 in the IGCT version: 700 mm for each converter unit
When option **L49** is simultaneously selected, the width does not have to be further increased.

Option combination exclusions		L51	L52
Disconnecter at the converter output	L51		–
Circuit breaker at converter output	L52	–	

–	Options cannot be combined
---	----------------------------

L53**UPS for the power supply of the open-loop and closed-loop control
(only for SINAMICS GM150)**

If there is a danger of voltage dips and brief line supply failures in the plant, then the drive can continue to operate if the closed-loop control is supplied from a UPS. The prerequisite for continued operation is that the DC link voltage does not fall below the $V_{d, \min}$ limit and the medium-voltage switch does not trip due to an undervoltage condition. This means that the drive can tolerate voltage dips up to brief line supply failures; this is especially true if the driven load has a high moment of inertia and the DC link can be kinetically buffered.

In the case of line supply interruptions that cause the power section to shut down, the downtime is reduced using the automatic restart function (option **L32**). The UPS is configured for a buffer time of up to 10 min.

Note:

Option **L53** limits the ambient temperature for storage and transport as follows:

- Storage and transport: –15 to +50 °C (standard: –25 to +70 °C)

When option **M66** (suitable for marine use) is simultaneously selected, the following ambient temperatures apply for operation:

- Continuous operation: 0 to +40 °C (standard: +5 to +40 °C)
- Operation < 2 h/d: 0 to +45 °C

L55**Anti-condensation heating for the cabinet**

The anti-condensation heating is recommended at low ambient temperatures and high levels of humidity to prevent condensation. The number of 100 W switch cabinet unit heaters fitted depends on the number of cabinet panels. The anti-condensation heaters are controlled by means of a thermostat. Should the external auxiliary infeed fail, this is monitored and reported by the converter for safety reasons.

The power supply for the anti-condensation heating (110 V to 240 V AC) must be provided externally.

L60**EMERGENCY STOP, Stop Category 1 for controlled stopping
(only for SINAMICS GM150)**

For uncontrolled stopping, the standard converter is equipped with an EMERGENCY OFF function, which involves integrating an external safety circuit and a positively opening mushroom pushbutton at the front of the unit. When the mushroom pushbutton is pressed, the line supply voltage is disconnected from the converter through the circuit breaker and the motor then coasts down.

As a supplement, the "EMERGENCY STOP, Stop Category 1" function is available with option **L60** (acc. to EN 60204-1:2006/A1:2009). This includes stopping the drive in an open-loop controlled fashion using a fast stop along a down ramp that has to be parameterized by the user. The line supply is then disconnected from the converter – the same as for EMERGENCY OFF – via the time-delayed contact of the safety relay being used. The duration should be set at the safety relay corresponding to the selected down ramp. The selection and the feedback signal of the "EMERGENCY STOP, Stop Category 1" function are connected to the customer terminal block.

Note:

The auxiliary power circuits are *not* disconnected (neither by the EMERGENCY OFF pushbutton, nor by the EMERGENCY STOP of option L60).

Among others, depending on the safety relay selected (single-channel or two-channel) and the selected fault detection (e.g. using cyclic tests) a maximum of Safety Category 3 according to EN ISO 13849-1:2006 can be achieved for the "EMERGENCY STOP, Stop Category 1" function.

Notice:

The braking process can take considerable time even with an EMERGENCY STOP, stop Category 1. Among other things, this depends on the total moment of inertia of the drive train. It may be necessary to use a Braking Module (option **L72**).

In addition to option **L60**, the "Safe Torque Off (STO)" safety function is available as option **K80** on request. The two options are compared in the following table.

	Option L60 EMERGENCY STOP, Stop Category 1 for controlled stopping	Option K80 Safe Torque Off (STO)
Functionality	When activated, the drive is braked down to zero speed and the energy feed to the converter is then interrupted by opening the circuit breaker. In addition to the software intervention (OFF3), a safety relay also ensures that the circuit breaker reliably opens.	When activated, the torque-generating energy feed to the motor is interrupted immediately. Then the gating commands of the power semiconductors are safely inhibited. Without further engineering, the motor coasts down. The circuit breaker remains closed so that the converter is still connected to the power supply.
Assured safety feature	The converter is disconnected from the power after the selected delay time of the safety relay has expired	Driving torque is safely switched off according to safety category
Safety category	Up to category 3 acc. to EN ISO 13849-1:2006 can be achieved, depending on the circuit arrangement of the safety relay and the fault detection using separate tests.	EN ISO 13849-1:2015 (Cat 3, PL e) IEC 61508-5-1:2010 (SIL 3)

	Option L60 EMERGENCY STOP, Stop Category 1 for controlled stopping	Option K80 Safe Torque Off (STO)
Certification of the option	No; however, the German Statutory Industrial Accident Insurance Association has certified the safety relay	Yes; by TÜV Süd [German Technical Inspectorate]
User view	The user is responsible for configuring and implementing the safety function.	The safety function is prepared for a certification of the converter as part of a complete plant or system.
Availability	SINAMICS GM150	SINAMICS GM150 and SINAMICS SM150 in all versions

L72 Braking Module

In order to permit braking operation for Basic Infeed (SINAMICS GM150) or for Active Infeed (SINAMICS SM150) to be able to brake even if the power fails, a Braking Module with braking resistor can be used. The mechanical design of the Braking Module largely corresponds to that of a Motor Module; the actual version is adapted to the converter cooling type (air or water cooling).

The following should be ensured when engineering:

- Shielded cables should be used just the same as at the converter output.
- Regarding the braking resistor and cable routing, the following requirements are placed on inductance L : The time constant L/R must not exceed $20 \mu\text{s}$, i.e. L must be less than $R \times 20 \mu\text{s}$.
- The deionized water requirement of the cooling unit is higher than specified in the technical data (see below, "Notes on the deionized water requirement").
- The maximum cable length between the Braking Module and braking resistor depends on the specific plant or system, and is obtained from the condition $L/R < 20 \mu\text{s}$ – taking into account the formula for the inductance per unit length $L' = L/a$. The maximum cable length is therefore: $a < 20 \mu\text{s} \cdot R/L'$
Example:
For a braking resistor with 9.5Ω and an inductance of 0.25 mH/km , the maximum cable length is 760 m . As a consequence, for single cables, the braking resistor must be less than 380 m away (cables routed in both directions). For cables routed in parallel, the length doubles as the inductance is halved.

Note:

An external load resistor is connected as the braking resistor. This is not included in the scope of supply (option **Y73**).

Notice:

With option **L72** the cabinet width is increased as follows:

- SINAMICS GM150 in the 12-pulse IGBT version: 600 mm
- SINAMICS SM150 in the IGCT version: 1800 mm

7.2 Description of the options

Option combination exclusions		L72	M61	M64
Braking Module	L72		-	✓ 1)
Redundant fan in the power section	M61	-		-
Converter prepared for connection to an external air discharge system	M64	✓ 1)	-	

- Options cannot be combined

In addition the following applies:

For SINAMICS GM150 in the IGCT version, option **L72** cannot be combined with options **N15 or N16** (24/36-pulse Basic Line Module).

Braking power of the Braking Module with external braking resistor:

Converter output voltage	Cooling method	Required braking resistor (± 10 %)	Braking resistance supply voltage	Braking power Braking Module	
				P ₂₀	P _{DB}
kV		Ω	kV	kW	kW
SINAMICS GM150 in the IGBT version					
2.3	Air	9.5	4.1	1000	333
	Water	7.5	4.1	1250	417
3.3	Air	13.5	5.8	1400	467
	Water	11	5.8	1700	567
4.16	Air	17.5	7.5	1800	600
	Water	14	7.5	2250	750
SINAMICS GM150 in the IGCT version and SINAMICS SM150 in the IGCT version					
3.3	Water	2 × 2.2	5.8	4000 ¹⁾	4000

1) Values can be higher for brief periods (in the range of seconds).

Note:

The data in the table above apply for the maximum utilization of the Braking Module. Different values for braking resistors are available on request.

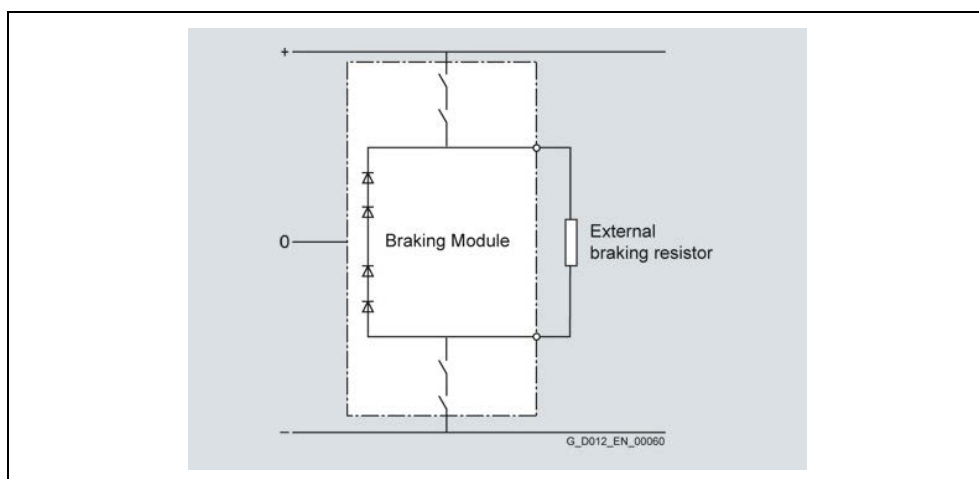

Fig. 7-5 Block diagram, Braking Module with braking resistor

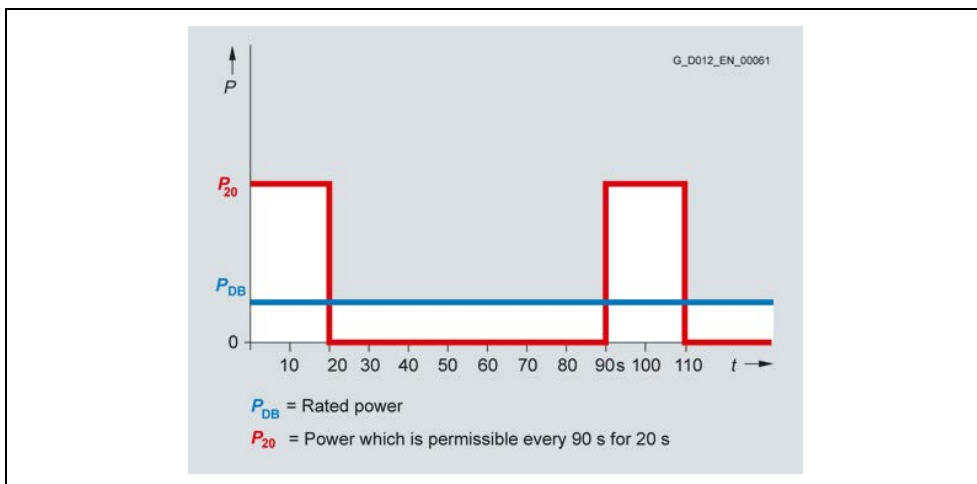

Fig. 7-6 Load diagram

Notes on the deionized water requirement:

When operating the water-cooled braking modules, the deionized water requirement increases compared to the values specified in the technical data. The following table shows the additional quantity of deionized water required for the various converter versions.

Converter output voltage	Circuit design	Additional deionized water quantity Braking Modules
kV		l
SINAMICS GM150 in IGBT version		
2.3 3.3 4.16	Basic circuit Parallel circuit	Approx. 5
SINAMICS GM150 in IGCT version		
3.3	Basic circuit	Approx. 5
	Parallel circuit	Approx. 2 x 5
	Triple parallel circuit	Approx. 3 x 5
SINAMICS SM150 in IGBT version		
3.3 4.16	Basic circuit	Approx. 5
SINAMICS SM150 in IGCT version		
3.3	Basic circuit	Approx. 5
	Parallel circuit	Approx. 2 x 5
	Triple parallel circuit	Approx. 3 x 5

L78**Output reactor with damping (only for IGBT versions; on request)**

With option **L78**, longer motor cable lengths can be used than with the output reactor of option **L08** (see **L08** description). For plant- or system-specific solutions, please contact your Siemens sales partner.

Option combination exclusions		L08	L78	Y15
Output reactor	L08		–	–
Output reactor with damping	L78	–		–
Sine-wave filter	Y15	–	–	

–	Options cannot be combined
---	----------------------------

L87**Rotor ground fault monitoring (only for static excitation unit)**

Option **L87** provides integrated ground fault monitoring for the rotor circuit.

L88**Ground fault monitoring with analog output (only for static excitation unit)**

Option **L88** provides integrated ground fault monitoring for the excitation circuit.

When compared to option **L87**, the insulation monitoring device offers the following additional functions:

- Historical data memory with real-time clock to save alarm messages with date/time
- Electrically isolated RS-485 interface for data exchange (BMS protocol)
- Line isolating relay when operating several ground fault monitors in coupled IT line systems
- Current output, 0/4 to 20 mA (electrically isolated)

L95**Evaluation of 6 Pt100 or Pt1000 resistance thermometers for explosion protection**

6 Ex-i resistance isolators are connected upstream of a TM150 Terminal Module (e.g. type 9180/10-77-11s, from the Stahl company).

The resistance thermometers are connected in a three-wire or four-wire circuit directly at the resistance isolators using screw terminals. There are no intermediate terminals.

Note:

Option **L95** can only be ordered in conjunction with either option **G51** or **G53** (TM150 temperature sensor evaluation units).

L96**Evaluation of 12 Pt100 or Pt1000 resistance thermometers for explosion protection**

12 Ex-i resistance isolators are connected upstream of a TM150 Terminal Module (e.g. type 9180/10-77-11s, from the Stahl company).

The resistance thermometers are connected in a three-wire or four-wire circuit directly at the resistance isolators using screw terminals. There are no intermediate terminals.

Note:

Option **L96** can only be ordered in conjunction with either option **G52** or **G53** (TM150 temperature sensor evaluation units).

M10**Safety interlocking system**

The safety interlocking system is based on the key transfer system developed developed by Castell. It is a supplementary mechanism to the electromagnetic door locking system integrated as standard. To obtain the coded key of the key exchange unit, the medium-voltage circuit breaker must first be opened. The opened medium-voltage circuit breaker releases the keys to the key exchange unit, which in turn releases the keys to the converter cabinet doors of the power section. This ensures that the converter is isolated from the medium voltage and that the medium voltage is no longer present in the cabinet. As long as the cabinet doors are not closed again and the keys of the converter cabinet doors are not put back into the key exchange unit, the key for the medium-voltage circuit breaker will not be released and the medium-voltage circuit breaker cannot be reclosed.

M11**Dust protection (only for air cooling)**

With option **M11** additional filter mats are installed in the cabinet doors in order to protect the power components against dangerous dusts. The filter mats are fitted to the outside of the cabinet doors, which means that they can be replaced during operation.

A differential pressure technique continually determines the amount of dust in the filter mats. A maintenance request is issued in plenty of time before the filter mats get clogged up.

When replacing the filter mats, it must be ensured that no dust gets into the cabinet unit through the air pulled in by the cabinet fans as they run.

It is recommended that option M11 is always ordered when converters are used in steel mills, rolling mills and cement plants to protect them against the high levels of prevailing dust.

Note:

For SINAMICS SM150 in the IGCT version, the filter mats are included as standard.

M13

Power cables at the converter input connected from the top (only for SINAMICS GM150 in the IGBT version; for SINAMICS SM150 in the IGCT version, on request)

Given suitable installation conditions, option **M13** enables the line-side power cable to be introduced into the cabinet unit from the top.

Notice:

Option **M13** increases the width of the cabinet unit by 600 mm.

Note:

Option **M13** is included in option **M78** (power cables at the converter output connected from the top).

M16

Extended dust protection (only for SINAMICS GM150 in water-cooled IGBT version)

Opening the cabinet doors before commissioning (e.g. to route connecting cables) can mean, in certain environments, that the converter is polluted, for example as a result of welding operations. Option **M16** involves installing a dust protection cover manufactured out of polycarbonate (Makrolon) inside the converter. This dust protection cover reduces the amount of pollution that can get to the converter components through open doors, therefore minimizing cleaning costs for the converter.

Note:

Commissioning personnel must remove the dust protection cover of the converter prior to commissioning.

When option **M66** (suitable for marine use) is selected, then it is recommended to simultaneously order option **M16**.

M32

Customer terminal block with spring-loaded terminals for signal cables up to 2.5 mm² (standard for IGBT versions)

For the IGCT versions of SINAMICS GM150 and SINAMICS SM150 converters, as standard the signal cable is directly connected at the terminals of the TM31 and TM15 Terminal Modules. It must be noted that the maximum connectable cross section for TM31 and TM15 is limited to 1.5 mm².

With option **M32**, the signals are fed to a terminal block with spring-loaded terminals. In this case, connection cross-sections of up to 2.5 mm² are permitted.

Option combination exclusions		M32	M33
Customer terminal block with spring-loaded terminals for signal cables up to 2.5 mm ²	M32		-
Customer terminal block with screw terminals for signal cables up to 2.5 mm ²	M33	-	

-	Options cannot be combined
---	----------------------------

M33**Customer terminal block with screw terminals for signal cables up to 2.5 mm²**

As standard, the signals are fed out to a terminal strip where the connection is directly established at the terminals (IGCT versions) or via spring-loaded terminals (IGBT versions). Cross-sections up to 1.5 mm² (IGCT versions) or 2.5 mm² (IGBT versions) are permitted.

With option **M33**, the signals are fed out to a terminal block with screw terminals. Cross-sections up to 2.5 mm² are also permitted here.

M34**Connection of auxiliary voltage and signal cables from the top (only for SINAMICS GM150 in the IGBT version)**

Given suitable installation conditions, option **M34** enables the auxiliary infeed and the signal cable to be introduced into the cabinet unit from the top.

Note:

Option **M34** requires that one of the options **M32** (customer terminal block with spring-loaded terminals, standard for IGBT versions) or **M33** (customer terminal block with screw terminals) must be simultaneously ordered.

M36**Brass cable entry for power cables (not available for SINAMICS SM150 in the IGBT version)**

With option **M36** the converter is supplied with a brass cable entry for the power cables. For versions with single-conductor cables, option **M36** is required to prevent circulating currents flowing in the cable gland.

Note:

The cable entry is manufactured out of 1.5 mm thick brass.

M42**IP42 degree of protection (only for air-cooled IGBT versions)**

With option **M42**, the degree of protection of the air-cooled converters can be enhanced (IP22 is standard). Additional close-meshed grilles where the air comes in and goes out prevent the ingress of solid matter with diameters > 1.0 mm.

M44**IP44 degree of protection (only available for SINAMICS GM150 in water-cooled version and SINAMICS SM150 in the IGCT version)**

With option **M44**, the degree of protection of the water-cooled converters can be enhanced (IP43 is standard).

7.2 Description of the options

M54**IP54 degree of protection (only for SINAMICS GM150 in water-cooled version and SINAMICS SM150 in the IGCT version)**

With option **M54**, the degree of protection of the water-cooled converters can be enhanced (IP43 is standard).

M61**Redundant fan in the power section (only for SINAMICS GM150 in the air-cooled IGBT version)**

To improve system availability, it is possible to equip the converter with an additional redundantly operating fan. If a fan within the converter cabinet unit fails, this is immediately detected by the differential pressure detector in the cabinet and the redundant fan is activated by the converter controller without the converter and hence the drive system failing. This enables production down times or interruptions to be avoided and replacement of the faulty fan to be postponed until the next scheduled shutdown.

Note:

Option **M61** is not available for all converters. The following tables list the restrictions to be taken into consideration.

For the following converters, the cabinet width must be increased by 600 mm:

Rated voltage	Converter
2.3 kV	6SL3810-2LM36-0AA3
	6SL3810-2LM37-0AA3
	6SL3810-2LM38-0AA3
3.3 kV	6SL3810-2LN36-0AA3
	6SL3810-2LN37-0AA3
	6SL3810-2LN38-0AA3
4.16 kV	6SL3810-2LP35-3AA3

For the following converters, the cabinet width must be increased by 600 mm and the air intake temperature must be limited to a maximum of +35 °C:

Rated voltage	Converter
4.16 kV	6SL3810-2LP36-0AA3
	6SL3810-2LP37-0AA3
	6SL3810-2LP38-0AA3

The following converters cannot be ordered with option M61:

Rated voltage	Converter
3.3 kV	6SL3810-2LN41-4AA3
4.16 kV	6SL3810-2LP41-1AA3
	6SL3810-2LP41-2AA3
	6SL3810-2LP41-4AA3

Option combination exclusions		L72	M61	M64
Braking Module	L72		-	✓
Redundant fan in the power section	M61	-		-
Converter prepared for connection to an external air discharge system	M64	✓	-	

-	Options cannot be combined
---	----------------------------

M64

Converter prepared for connection to an external air discharge system, with internal cabinet fans (only for SINAMICS GM150 in the air-cooled IGBT version)

Retaining the fans inside the cabinet unit ensures that the volume of cool air required for cooling can be supplied without any major distribution faults occurring. If the exhaust air is led in a duct system over long sections or even around bends, the pressure drop that arises in this duct system must be compensated by additional fans within the exhaust air system. Suitable "flange connections" for connecting the converter to an external air discharge system are located in the roof section of the cabinet unit.

Note:

For exclusions with other options, see description of option **M61**.

M66

Suitable for marine use (only for water-cooled converters)

With option **M66**, the version of the converter meets the requirements of the following classification organizations:

- Lloyds Register
- American Bureau of Shipping
- Det Norske Veritas, Germanischer Lloyd
- Bureau Veritas
- China Classification Society

Option **M66** includes a seawater-proof paint finish, a strengthened mechanical design of the cabinet, handrails below the operator panel and a mechanical locking system for the cabinet doors. The cabinet has degree of protection IP44, includes anti-condensation heating (option **L55**) and can be either screwed or welded to the ship's structure to mount the converter (but with SINAMICS GM150 in IGCT version, welding is required).

7.2 Description of the options

Note:

For SINAMICS GM150 in IGCT version, the converter cabinet must be welded to the ship's structure.

For SINAMICS GM150 in the IGBT version, the cabinet has a reinforced base frame. This increases the cabinet height by 100 mm. (The cabinet in the IGCT version is already equipped with an appropriate base frame as standard).

With option **M66**, the following modified environmental conditions in operation change when compared to standard values:

- Ambient temperature:
 - without derating: **0 °C** to +45 °C (standard: +5 °C to +40 °C)
 - with derating: > +45 °C (derating curve available on request)
- Relative humidity: 5 % to **95 %** (standard: 5 % bis 85 %)

When option **M66** is selected, then it is recommended to simultaneously order option **M16** (extended dust protection).

If the converter is to be used as a safety-relevant drive ("essential service") on a ship, individual certification is additionally required (options **E21 to E71**).

M78

**Power cables at the converter output connected from the top
(only for SINAMICS GM150 in the IGBT version; for SINAMICS SM150 in IGCT version, on request)**

Given suitable installation conditions, option **M78** enables the motor-side power cable to be introduced into the cabinet unit from the top.

Note:

Option **M78** includes option **M13** (power cables at the converter input connected from the top).

Notice:

Option **M78** increases the cabinet width by 600 mm.

N06 to N08

**Capacitor Modules to increase the DC link capacitance
(only for SINAMICS SM150 in the IGCT version; with diode infeed on request)**

With options **N06 to N08** the converter is shipped with Capacitor Modules to increase the DC link capacitance. The increase for each sub DC link is 6, 12 or 18 mF.

Note:

Options **N06 to N08** are only available for single and parallel circuit configurations with Article numbers 6SL3845-7NN42-2AA3, 6SL3845-7NN44-5AA3 and 6SL3845-7NN46-7AA3. They are not available for DC bus configurations. With these options, the cabinet width per converter unit is increased (see the following table).

Number of Capacitor Modules	Option	Additional cabinet width per converter unit	DC link capacitance per sub DC link
0	–	–	12 mF
1	N06	970 mm	18 mF
2	N07	1940 mm	24 mF
3	N08	2910 mm	30 mF

Option combination exclusions		N06	N07	N08
Capacitor Module to increase the DC link capacitance (1 module)	N06		–	–
Capacitor Modules to increase the DC link capacitance (2 modules)	N07	–		–
Capacitor Modules to increase the DC link capacitance (3 modules)	N08	–	–	

–	Options cannot be combined
---	----------------------------

N13**Circuit breaker at the converter input**

(SINAMICS GM150: for 24-pulse Basic Line Modules, only on request; not available for IGCT version with converter units operated in parallel
SINAMICS SM150: not available for IGBT version, for IGCT version, available on request)

Option **N13** provides integrated circuit breakers. Option **N13** is particularly important in the retrofit business where existing circuit breakers do not meet requirements (tripping times, low-voltage coil). The circuit breakers are installed below the Basic Line Module in the converter cabinet and are thus located on the secondary side of the line-side transformer.

Notice:

Option N13 increases the width of the cabinet as follows:

- SINAMICS GM150 in the IGBT version: 600 mm
- SINAMICS GM150 in the IGCT version: 2 × 700 mm

Note:

In conjunction with option **C55** (auxiliary power supply for open-loop and closed-loop control), as well as for converters with 24-pulse Basic Line Module, for option **N13** a special request is required.

Option combination exclusions		N13	N15	N16
Circuit breaker at the converter input	N13		–	–
24-pulse Basic Line Module	N15	–		–
36-pulse Basic Line Module	N16	–	–	

–	Options cannot be combined
---	----------------------------

N15

24-pulse Basic Line Module (only for SINAMICS GM150 and SINAMICS SM150 in the IGCT version with diode infeed)

For particularly high requirements regarding low line harmonics, the power sections of voltage ranges 2.3 kV, 3.3 kV and 4.16 kV can be equipped with a 24-pulse Basic Line Module. (circuit version (2) for IGBT version, circuit version (8) for IGCT version).

SINAMICS GM150 with power sections connected in parallel can also be operated 24-pulse without this option (circuit version (3)). The converter transformer required at the medium-voltage level must be designed as a five-winding transformer, or else two two-tier transformers must be provided. Vector groups and winding offsets must be appropriately engineered.

Notice:

With option **N15**, the width of the converter cabinet for SINAMICS GM150 in the IGBT version increases by 600 mm, and the deionized water requirement of the cooling unit is higher than that specified in the technical data.

Note: 24-pulse

For exclusions with other options, see description of option **N13**. Further, for SINAMICS GM150 in the IGCT version, option **N15** cannot be combined with option **L72** (Braking Module), and a request is required in conjunction with option **L48** (make-proof grounding switch at the converter input).

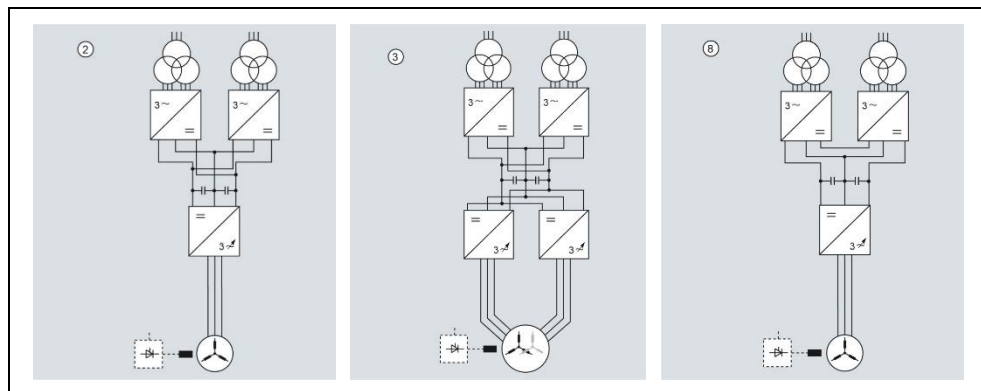

(2) SINAMICS GM150 in the IGBT version, basic circuit 2.3 kV to 4.16 kV (option N15)

(3) SINAMICS GM150 in the IGBT version, parallel circuit 2.3 kV to 4.16 kV
(24-pulse infeed as standard)

(8) SINAMICS GM150 in the IGCT version (option N15)

The circuit for the 24-pulse infeed is implemented in different ways for SINAMICS GM150 in the IGBT version and in the IGCT version. The two following diagrams should clearly show the principle difference between the parallel connection (for IGBT) and the series connection (for IGCT). The Basic Line Modules (each with two diode rectifiers) are supplied from two 3-winding transformers with $\pm 7.5^\circ$ shift on the primary side. 12-pulse operation applies as a result of the 30° phase shift between the two rectifiers of a DC link half. For the same load of the halves, 24-pulse operation is achieved as the infeeds of the two DC link halves are phase shifted through 15° with respect to one another. In the case of IGBTs, the deviation of the secondary voltage of a transformer under load conditions may be a maximum of 1 %.

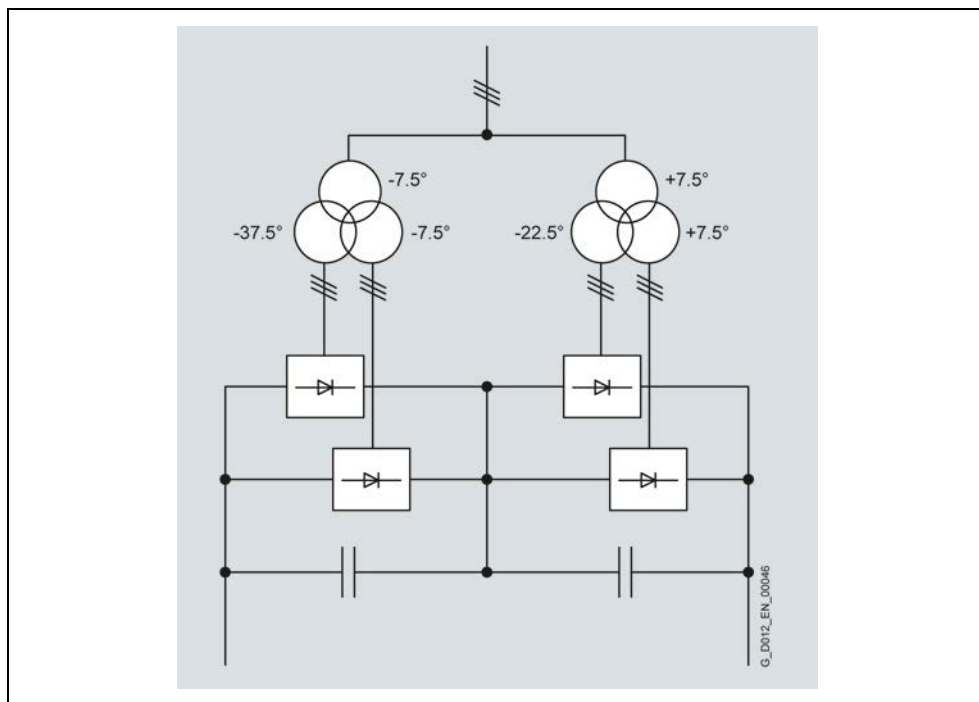

Fig. 7-7 SINAMICS GM150 in the IGBT version, 24-pulse infeed by connecting two Basic Line Modules in parallel (absolute values of the individual phase shift angles as example only)

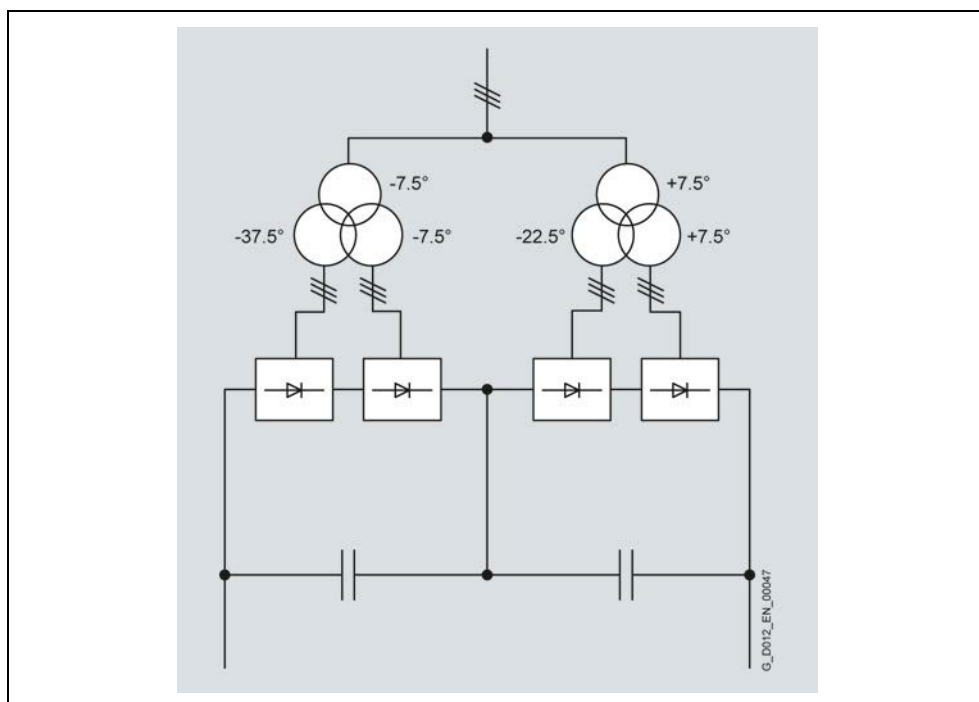

Fig. 7-8 SINAMICS GM150 in the IGCT version, 24-pulse infeed by connecting two Basic Line Modules in series (absolute values of the individual phase offset angles are examples only)

N16**36-pulse Basic Line Module (only for SINAMICS GM150; IGCT version on request)**

For the highest requirements regarding low line harmonics, power sections of the SINAMICS GM150 can be equipped with a 36-pulse Basic Line Module.

Notice:

With option **N16**, the cabinet width is increased as follows:

- SINAMICS GM150 in the IGBT version, basic circuit: 1200 mm
- SINAMICS GM150 in the IGBT version, parallel circuit: 600 m

Note:

- With option **N16**, the deionized water requirement of the cooling unit is higher than specified in the technical data.
- For exclusions with other options, see description of option **N13**. Further, option **N16** in conjunction with options **L72** (Braking Module) and **K66** (power section with internal cooling) must be requested.

N22**Switch on the input side (only for static excitation unit)**

When option **N22** is selected, a circuit breaker which is controlled by the static excitation unit itself is integrated on the input side. On the variants for brushless reverse field excitation this circuit breaker is configured as a contactor, on the variants for slipring excitation as a disconnecter.

Note:

If this circuit breaker is not available, an external circuit breaker must be provided.

N30 to N33**Controlled motor feeder for auxiliaries 400 V 3 AC / 480 V 3 AC**

An outgoing feeder for the operation of external auxiliary equipment, e.g. separate fans on the motor or pumps/oil supplies, is available in the converter. It is controlled and is fused by motor circuit breakers. The voltage supply required for the drive must be provided from an external source.

Depending on the drive output that is required, four different outgoing feeders are available.

The contactor is closed with the **ON** command at the drive and opened with the **OFF** command.

Option	Description
N30	Controlled motor feeder for auxiliaries 400 V 3 AC 50 Hz, max. 4 kW or 480 V 3 AC 60 Hz, max. 4.8 kW (cos ϕ = 0.8; circuit breaker setting range from 9 A to 12.5 A)
N31	Controlled motor feeder for auxiliaries 400 V 3 AC 50 Hz, max. 7 kW or 480 V 3 AC 60 Hz, max. 8 kW (cos ϕ = 0.8; circuit breaker setting range from 14 A to 20 A)
N32	Controlled motor feeder for auxiliaries 400 V 3 AC 50 Hz, max. 11 kW or 480 V 3 AC 60 Hz, max. 12.7 kW (cos ϕ = 0.8; circuit breaker setting range from 18 A to 25 A)
N33	Controlled motor feeder for auxiliaries 400 V 3 AC 50 Hz, max. 15 kW or 480 V 3 AC 60 Hz, max. 17.5 kW (cos ϕ = 0.8; circuit breaker setting range from 28 A to 40 A)

Note:

Other voltages are also possible according to the ratings in question.

Option combination exclusions		N30	N31	N32	N33
400 V 3 AC 50 Hz, max. 4 kW or 480 V 3 AC 60 Hz, max. 4.8 kW	N30		-	-	-
400 V 3 AC 50 Hz, max. 7 kW or 480 V 3 AC 60 Hz, max. 8 kW	N31	-		-	-
400 V 3 AC 50 Hz, max. 11 kW or 480 V 3 AC 60 Hz, max. 12.7 kW	N32	-	-		-
400 V 3 AC 50 Hz, max. 15 kW or 480 V 3 AC 60 Hz, max. 17.5 kW	N33	-	-	-	

-	Options cannot be combined
---	----------------------------

7.2 Description of the options

N35 to N38**Controlled outgoing feeder for auxiliaries 230 V 1 AC / 120 V 1 AC**

A controlled outgoing feeder protected by miniature circuit breakers is available in the converter for controlling external auxiliaries, e.g. the anti-condensation heating for the motor. The infeed required for the voltage supply, e.g. the anti-condensation heating, must be provided externally.

Depending on the output that is required, four different outgoing feeders are available.

The contactor is opened with the **ON** command at the converter and closed with the **OFF** command.

Option	Description
N35	Controlled outgoing feeder for auxiliaries 230 V 1 AC 50 Hz, max. 1.2 kW or 120 V 1 AC 60 Hz, max. 1 kW
N36	Controlled outgoing feeder for auxiliaries 230 V 1 AC 50 Hz, max. 2.2 kW or 120 V 1 AC 60 Hz, max. 1.5 kW
N37	Controlled outgoing feeder for auxiliaries 230 V 1 AC 50 Hz, max. 3.5 kW or 120 V 1 AC 60 Hz, max. 2.1 kW
N38	Controlled outgoing feeder for auxiliaries 230 V 1 AC 50 Hz, max. 4.5 kW or 120 V 1 AC 60 Hz, max. 2.8 kW

Option combination exclusions		N35	N36	N37	N38
230 V 1 AC 50 Hz, max. 1.2 kW or 120 V 1 AC 60 Hz, max. 1 kW	N35		-	-	-
230 V 1 AC 50 Hz, max. 2.2 kW or 120 V 1 AC 60 Hz, max. 1.5 kW	N36	-		-	-
230 V 1 AC 50 Hz, max. 3.5 kW or 120 V 1 AC 60 Hz, max. 2.1 kW	N37	-	-		-
230 V 1 AC 50 Hz, max. 4.5 kW or 120 V 1 AC 60 Hz, max. 2.8 kW	N38	-	-	-	

-	Options cannot be combined
---	----------------------------

Q80 to Q88**Extension of the liability for defects**

We can offer the possibility of extending the liability for defects periods beyond the standard liability for defects period. The standard liability for defects period, as listed in the standard conditions for the supply of services and products, is 12 months.

Extension of the liability for defects period after the product has already been delivered

If a product has already been delivered, an extended liability for defects period can be ordered as long as the converter has still not been commissioned and was stored for no longer than two years. When ordering, in addition to the article number specified on the rating plate, the serial number is also required.

Note:

You must obtain a quotation from your Siemens sales partner before ordering an extension of the liability for defects.

Options Q80 to Q85**Extension of the liability for defects period when ordering new products**

When ordering new products, the standard liability for defects period can be optionally extended for an additional price.

With SIDRIVE IQ – options Q86 to Q88

SIDRIVE IQ digitalization packages with a validity period of at least three years – can be ordered by selecting option **C68** (SINAMICS CONNECT 500) – automatically extend the liability for defects period for the converters by the same time period.

Options		Validity period of the SIDRIVE IQ subscription	Article No. for using SIDRIVE IQ	
			Registration	Expert assistance
C68	Q86	3 years	9LD3230-5BA00-0AF0	9LD4110-1XX83-8HF3
	Q87	4 years	9LD3230-5BA00-0AG0	9LD4110-1XX83-8HF4
	Q88	5 years	9LD3230-5BA00-0AH0	9LD4110-1XX83-8HF5

Additional information on SIDRIVE IQ is provided in the Internet at www.siemens.com/sidrive-iq.

Note:

Options **M66** (marine use) and **E21** to **E71** (individual certification) cannot be combined with option **C68**.

The following table provides an overview of all of the options to extend the liability for defects period.

7.2 Description of the options

Option	Description
Q80	Extension of the liability for defects period by 12 months to a total of 24 months (2 years) from delivery
Q81	Extension of the liability for defects period by 18 months to a total of 30 months (2.5 years) from delivery
Q82	Extension of the liability for defects period by 24 months to a total of 36 months (3 years) from delivery
Q83	Extension of the liability for defects period by 30 months to a total of 42 months (3.5 years) from delivery
Q84	Extension of the liability for defects period by 36 months to a total of 48 months (4 years) from delivery
Q85	Extension of the liability for defects period by 48 months to a total of 60 months (5 years) from delivery
Q86	Extension of the liability for defects period by 24 months to a total of 36 months (3 years) from delivery, with SIDRIVE IQ Included in SIDRIVE IQ digitalization package, 3 year validity period
Q87	Extension of the liability for defects period by 36 months to a total of 48 months (4 years) from delivery, with SIDRIVE IQ Included in SIDRIVE IQ digitalization package, 4 year validity period
Q88	Extension of the liability for defects period by 48 months to a total of 60 months (5 years) from delivery, with SIDRIVE IQ Included in SIDRIVE IQ digitalization package, 5 year validity period

Exclusions of extensions of the liability for defects period		Q80	Q81	Q82	Q83	Q84	Q85	Q86	Q87	Q88
Extension to 24 months	Q80		-	-	-	-	-	-	-	-
Extension to 30 months	Q81	-		-	-	-	-	-	-	-
Extension to 36 months	Q82	-	-		-	-	-	-	-	-
Extension to 42 months	Q83	-	-	-		-	-	-	-	-
Extension to 48 months	Q84	-	-	-	-		-	-	-	-
Extension to 60 months	Q85	-	-	-	-	-		-	-	-
Extension to 36 months, with SIDRIVE IQ	Q86	-	-	-	-	-	-		-	-
Extension to 48 months, with SIDRIVE IQ	Q87	-	-	-	-	-	-	-		-
Extension to 60 months, with SIDRIVE IQ	Q88	-	-	-	-	-	-	-	-	

✓	Options can be combined
-	Options cannot be combined

T58, T60, T80, T82, T85, T86, T90, T91
Rating plate languages

The rating plate is normally supplied in two languages (English/German). Other languages can be ordered using the codes below.

Option	Description
T58	Rating plate in English/French
T60	Rating plate in English/Spanish
T80	Rating plate in English/Italian
T82	Rating plate in English/Portuguese (on request)
T85	Rating plate in English/Russian (on request)
T86	Rating plate in English/Polish (on request)
T90	Rating plate in English/Japanese (on request)
T91	Rating plate in English/Chinese (on request)

Option combination exclusions		T58	T60	T80	T82	T85	T86	T90	T91
English/French	T58		-	-	-	-	-	-	-
English/Spanish	T60	-		-	-	-	-	-	-
English/Italian	T80	-	-		-	-	-	-	-
English/Portuguese (on request)	T82	-	-	-		-	-	-	-
English/Russian (on request)	T85	-	-	-	-		-	-	-
English/Polish (on request)	T86	-	-	-	-	-		-	-
English/Japanese (on request)	T90	-	-	-	-	-	-		-
English/Chinese (on request)	T91	-	-	-	-	-	-	-	

-	Options cannot be combined
---	----------------------------

U01**UL listing (only for SINAMICS SM150 in IGCT version; on request)**

With option **U01** a converter for the North American is supplied, approved according to UL347A with TÜV Süd as NRTL (Nationally Recognized Testing Laboratory).

Note:

Option **U01** requires that option **M10** is simultaneously ordered (safety interlocking system).

U03**CSA conformity (on request)**

With option **U03**, there is an approval according to CSA 22.2 No. 274-17 with TÜV Süd as NRTL (Nationally Recognized Testing Laboratory).

7.2 Description of the options

W02**Cooling unit with redundant stainless steel plate-type heat exchangers (only for water cooling)**

The cooling unit is used to dissipate the power loss from the converter and consists of two cooling circuits: the internal cooling circuit with deionized water and the external raw water circuit for dissipating the power loss. In the standard version the internal cooling circuit has two redundant circulating pumps and one stainless steel plate-type heat exchanger. With option **W02**, a second stainless steel plate-type heat exchanger is integrated to enable fully redundant operation.

Option combination exclusions		W02	W11	W12	W14	W20	Y40
Cooling unit with redundant stainless steel plate-type heat exchangers	W02		-	-	-	✓	-
Cooling unit with titanium plate-type heat exchanger	W11	-		-	-	✓	-
Cooling unit with redundant titanium plate-type heat exchangers	W12	-	-		-	✓	-
Converter without cooling unit, provided on the plant side	W14	-	-	-		-	-
Raw-water connection from the bottom	W20	✓	✓	✓	-		✓
Customer-specific system acceptance tests	Y40	-	-	-	-	✓	

✓	Options can be combined
-	Options cannot be combined

W11**Cooling unit with titanium plate-type heat exchanger (only for water cooling, on request)**

If the raw water specified in the technical specifications is not available for the cooling unit, option **W11** must be selected. This is required in the case of aggressive raw water such as seawater, for instance. With option **W11**, a titanium plate-type heat exchanger is installed instead of the stainless steel plate-type heat exchanger. The three-way valve for preventing condensation and the necessary pipe connections are still made from stainless steel.

Notice:

When option **W11** is selected, the piping on the raw water side is made of stainless steel, not titanium.

Note:

For exclusions with other options, see description of option **W02**.

W12**Cooling unit with redundant titanium plate-type heat exchangers
(only for water cooling)**

With option **W12**, two completely redundant titanium plate-type heat exchangers are integrated for the internal cooling circuit (other characteristics as described under option **W11**).

Notice:

When option **W12** is selected, the piping on the raw water side is made of stainless steel, not titanium.

Note:

For exclusions with other options, see description of option **W02**.

W14**Converter without cooling unit, provided on the plant side
(only for water cooling)**

When option **W14** is selected, the water-cooled converter is supplied without a cooling unit. The necessary cooling system must be provided on the plant side.

Note:

- As a minimum, the cooling system provided must comply with the properties defined in the cooling unit specifications. The specification is available on request.
- Option **W14** reduces the cabinet width and weight. The corresponding data is available on request.

Note:

For exclusions with other options, see description of option **W02**.

W20**Raw water connection from the bottom (only for SINAMICS GM150 in water-cooled IGBT version)**

Option **W20** enables the raw water for the cooling unit to be supplied from the bottom through the cabinet floor with a flange connection. The necessary mating flanges are included as a pack with the cooling unit.

Note:

With water-cooled IGBT converters, the raw water is supplied to the cooling unit through the side panel from the left-hand side. For converters in IGCT technology, the raw water is connected at the cooling unit from the bottom.

Note:

For exclusions with other options, see description of option **W02**.

W90**Converter without phase module (SINAMICS SM150 in IGCT version; on request)**

With option **W90**, the converter can be ordered without phase modules being equipped. This means that existing phase modules can continue to be used when a converter is replaced

Note:

There is no warranty for components reused in this way (e.g. phase modules).

Y05**Customer-specific rating plate**

With option **Y05** the data on the rating plate can be adapted for the specific plant or system, depending on the ambient conditions such as installation altitude or ambient temperature. This also involves data regarding the rated voltage, rated current and the frequency range at the converter output. The maximum values of the adapted rating plate are defined by the values of the standard rating plate, which correspond to the catalog data.

Y09**Special paint finish according to RAL ...**

Converters are normally supplied in RAL 7035 (light gray). With option **Y09** a special color can be ordered by specifying it in plain text.

Note:

For SINAMICS GM150 in the air-cooled version, the following applies: The fans still have their standard color even when the cabinet has a special paint finish.

Y10**Circuit diagrams with customer-specific text field**

The circuit diagrams are given customized headers.

The data for the header must be specified in plain text (up to three lines, with 45 characters per line).

Y15**Sine-wave filter (only for IGBT versions; on request)**

Sine-wave filters are required for the following applications:

- When operating old motors (retrofit)
- When operating third-party motors without taking supplementary measures for converter operation

The sine-wave filters supply the motors with almost sinusoidal motor currents and voltages so that line motors can be operated. The sine-wave filter operates optimally for motors with a rated frequency of 50 Hz or 60 Hz. It should be noted that only driven loads with a square-law load torque may be operated (e.g. pumps, fans). The output frequencies used in operation can lie in the range between 30 Hz and 66 Hz.

A field weakening range of 1:1.1 is permissible (max. 55 Hz for 50 Hz motors and max. 66 Hz for 60 Hz motors). When sine-wave filters are used, the voltage harmonic distortion at an output frequency of 50 Hz is less than 5 %.

If the sine-wave filter is used, the output of the converter must be reduced (see technical data).

Note:

The rated motor current, the motor current at the operating point and the motor no-load current must be specified in plain text when ordering filters.

Converter output voltage	Maximum cable lengths ¹⁾			
SINAMICS GM150 IGBT version				
	Without sine-wave filter (standard)		With sine-wave filter (Y15)	
	Shielded	Unshielded	Shielded	Unshielded ²⁾
2.3 kV to 4.16 kV	Up to 2 parallel cables: each 100 m 3 parallele Kabel: each 80 m 4 parallele Kabel: each 80 m	Not permitted	Each 1000 m	Each 1000 m

1) Distance converter-motor depending on current load for max. of four parallel three-conductor cables. Mechanically, up to six parallel cables are possible (on request).

2) Armored cables are recommended.

Notice:

Option Y15 increases the width of the cabinet unit.

Option combination exclusions		L08	L78	Y15
Output reactor	L08		-	-
Output reactor with damping	L78	-		-
Sine-wave filter	Y15	-	-	

-	Options cannot be combined
---	----------------------------

Y17

Line reactor (only for static excitation unit)

With option **Y17** a line reactor is integrated to protect against excessively high harmonic currents and to limit the line harmonics. The exact values for the reactor must be given in plain text as they are dependent on the supplying network.

Y26

Premagnetization unit (only for SINAMICS GM150; on request)

Option **Y26** allows the line transformer to be premagnetized to limit the inrush current.

Y35

Customer-specific cabinet labeling (only for SINAMICS SM150 in IGCT version)

With option **Y35**, labels provided by the customer in time will be attached to the converter cabinet.

Y40**Raw water data deviating from the catalog data (only for water cooling; on request)**

With option **Y40**, raw water whose data does not conform to the technical data can also be used with water-cooled converters (for specifications, see cooling unit). Deviations from the values indicated in the specification must be clarified in advance.

Note:

For exclusions with other options, see description of option **W02**.

Y73**Braking resistor (available for SINAMICS GM150; SINAMICS SM150 on request)**

The braking resistor is connected to the Braking Module (option **L72**) via two connections (SINAMICS GM150 in the IGBT version) or three connections (SINAMICS GM150 in the IGCT version and SINAMICS SM150 in the IGCT version). For dimensioning, refer to the Table in the description of option **L72**.

Notice:

The power loss of the braking resistor must be taken into account when dimensioning the room or the area in which the converters is mounted. If required, the braking resistor should be mounted outside the room/area. The braking resistor is equipped with a temperature monitor. This must be connected up so that when it responds, the converter is shut down. Regarding the braking resistor and cable routing, the following requirements are placed on inductance L : The time constant L/R must not exceed 20 ms, i.e. L must be less than $R \times 20$ ms.

The signal cables to the temperature monitoring and the power cables are not included in the scope of supply.

Note:

When ordering, the following data must be specified in plain text: max. rated power, braking duration and cycle. The technical data are obtained, based on this data (for example, dimensions, weight), whereby the following basic data apply to all resistors:

- Degree of protection IP20, with perforated sheet steel roof section manufactured out of V2A steel
- Cooling using an internal fan
- Digital feedback signal from the air flow switch and temperature switch
- Mounted outside the converter, in electrical rooms and areas
- Ambient temperature: max. converter ambient temperature
- Enclosure, painted, RAL 7035

8 Static excitation units



8.1 Static excitation unit versions

Overview

The following versions are available as static excitation units for SINAMICS medium voltage converters:

- Static excitation unit for separately excited synchronous motors with brushless rotating reverse-field excitation (on request only)
- Static excitation unit for separately excited synchronous motors with slip-ring excitation (see Chapter 8.4)

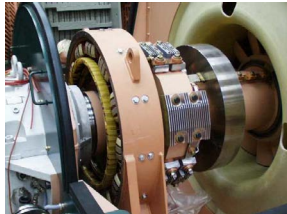
Table 8-1 Properties of static excitation units

	Brushless rotating reverse-field excitation	Slip-ring excitation
Article number	–	6RN8011...
Closed-loop control, open-loop control	On request	SINAMICS DCM
Performance	Standard (negative excitation voltage not possible)	High (negative excitation voltage possible)
Applications	<ul style="list-style-type: none"> • Compressors (oil and gas) • Ships 	<ul style="list-style-type: none"> • Rolling mills • Cross cutters and shears • Wire-drawing machines • Extruders and kneaders • Presses • Elevators and cranes • Cable railways • Conveyor systems for mining • Test stands
Control	PROFIBUS/PROFINET	PROFIBUS/PROFINET
Additional properties	<ul style="list-style-type: none"> • Limited dynamic response • Maintenance-free • Compact design 	<ul style="list-style-type: none"> • Higher dynamic performance (rolling mills) • Maintenance required (carbon brushes) • IT line supply required 

8.2 Use with medium voltage converters

Order

A static excitation unit must always be ordered together with the converter – however, with its own Article number. Add "-Z" to the article number of the converter and specify order code E01 or E02. It is not possible to order individual static excitation units.

Options required for communication with the converter

Table 8-2 Options required for communication

Converter	Closed-loop control	Converter option	Exciter option
SINAMICS GM150	SINAMICS CU320-2	–	G30 PROFIBUS master
SINAMICS SM150	SIMOTION D445-2	–	–
SINAMICS GL150	SINAMICS CU320-2	A15 SIMATIC S7 CPU	
SINAMICS SL150	SIMOTION D455-2	–	–
SINAMICS PERFECT HARMONY GH150	SINAMICS CU320-2	A13 SIMATIC S7 CPU	–
SINAMICS SH150	SINAMICS CU320-2	A13 SIMATIC S7 CPU	–
SINAMICS PERFECT HARMONY GH180	NXGII	–	G30 PROFIBUS master

Note:

An OA application can be chosen as further communication option between converter and excitation unit.

8.3 General technical data

8.3.1 Environmental conditions

	Storage	Transport	Operation
Climatic environmental conditions			
Ambient temperature	–25 ... +70 °C	–25 ... +70 °C	+5 ... +40 °C
Relative humidity	5 ... 95 % (only slight condensation permitted; converter must be completely dry before commissioning)	5 ... 95 % (only slight condensation permitted; converter must be completely dry before commissioning)	5 ... 85 % (condensation not permissible)
Other climatic conditions in accordance with Class	1K22 according to IEC 60721-3-1 (icing not permissible)	2K11 according to IEC 60721-3-2	3K22 according to IEC 60721-3-3
Degree of pollution	2 without conductive pollution according to IEC 61800-5-1	2 without conductive pollution according to IEC 61800-5-1	2 without conductive pollution according to IEC 61800-5-1
Mechanical environmental conditions			
in accordance with Class (increased strength for marine use)	1M11 according to IEC 60721-3-1	2M4 according to IEC 60721-3-2	3M11 according to IEC 60721-3-3
Other environmental conditions			
Biological environmental conditions in accordance with Class	1B1 according to IEC 60721-3-1	2B1 according to IEC 60721-3-2	3B1 according to IEC 60721-3-3 (without harmful flora)
Chemically active substances in accordance with Class	1C1 according to IEC 60721-3-1	2C1 according to IEC 60721-3-2	3C1 according to IEC 60721-3-3:1994 (no occurrence of salt mist)
Mechanically active substances in accordance with Class	1S11 according to IEC 60721-3-1	2S1 according to IEC 60721-3-2	3S6 according to IEC 60721-3-3

Note:

The values specified under storage and transport apply to suitably packed static excitation units.

8.3.2 Derating

Derating is not required when operating static excitation units with ambient temperatures less than or equal to 40 °C, and installation altitudes up to 1000 m. Information about derating for other conditions is available on request.

8.4 SINAMICS DCM for slip-ring excitation

8.4 SINAMICS DCM for slip-ring excitation

8.4.1 Selection and ordering data

Table 8-3 Selection and ordering data for slip-ring excitation

Rated continuous current A	Supply voltage V	Comment	Static excitation unit Article No.
500	400 3 AC	on request	6RN8011-5SE36-0AA0
500	460 3 AC	Suitable for marine use with type certificate; on request	6RN8011-7SE34-0AA0
1050	460 3 AC	–	6RN8011-2SE41-2AA0
1050	460 3 AC	Compact	6RN8011-3SE41-2AA0
1700	830 3 AC	–	6RN8011-0SJ42-0AA0
1800	690 3 AC	–	6RN8011-1SH42-0AA0
1900	950 3 AC	–	6RN8011-6SK42-2AA0
1100	690 3 AC	fuseless; on request	6RN8011-4SH41-1AA0

8.4.2 Accessories

Table 8-4 Accessories for slip-ring excitation

Designation	Article No.
PROFIBUS connecting cable between the basic unit and static excitation unit	
PROFIBUS cable	6XV1830-0EH10
Connection plug for PROFIBUS	
• <u>Without</u> PG/PC connection	6ES7972-0BA41-0XA0
• <u>With</u> PG/PC connection	6ES7972-0BB41-0XA0

8.4.3 Technical specifications

Table 8-1 Technical data slip-ring excitation

Slip-ring excitation		6RN8011-...				
		...-5SE36-0AA0 ¹⁾	...-7SE34-0AA0 ²⁾	...-2SE41-2AA0	...-3SE41-2AA0	
Rated continuous current	A	500	500	1050	1050	
Load cycle 20 s / 280 s	A	600/450	600/450	1200/1000	1200/1000	
Supply voltage	V	400 3 AC	460 3 AC	460 3 AC	460 3 AC	
Voltage range	%	-20 ... +15	-20 ... +15	-20 ... +15	-20 ... +15	
Rated supply frequency	Hz	50/60	50/60	50/60	50/60	
Frequency range	Hz	45 ... 65	45 ... 65	45 ... 65	45 ... 65	
Power loss at the rated continuous current	kW	1.8	1.8	4.3	4.3	
Electronics power supply	–	230 V 1 AC 2 A	230 V 1 AC, 2 A	230 V 1 AC 2 A	230 V 1 AC 2 A	
Fan power supply	–	400 V 3 AC, 50 Hz, 0.23 A 460 V 3 AC, 60 Hz, 0.26 A	400 V 3 AC, 50 Hz, 0.23 A 460 V 3 AC, 60 Hz, 0.26 A	230 V 1 AC, 50/60 Hz, 0.51/0.72 A	230 V 1 AC, 50/60 Hz, 0.51/0.72 A	
Max. current demand of the auxiliary supply 230 V 1 AC 50/60 Hz ³⁾	A	2.5	16	5.1	5.1	
Max. current demand of the auxiliary supply 400 V 3 AC 50/60 Hz	A	Plant-specific, typical 50	6	–	–	
Cooling air flow rate	m ³ /s	0.15	0.15	0.28	0.28	
Sound pressure level L _{pA} (1m)	dB(A)	< 73	< 76	< 76	< 76	
Measuring surface level L _s (1m)	dB(A)	17	17	17	16	
Cable cross-sections, line-side, max. connectable per phase	mm ²	2 x 185	1 x 95	4 x 240	4 x 240	
	AWG/MCM	2 x 350 MCM	1 x 3/0 AWG	4 x 500 MCM	4 x 500 MCM	
Cable cross-sections, motor-side, max. connectable per phase	mm ²	2 x 240	2 x 95	4 x 240	4 x 240	
	AWG/MCM	2 x 500 MCM	2 x 3/0 AWG	4 x 500 MCM	4 x 500 MCM	
PE connection, max. cross-section at the enclosure with M12 screw	mm ²	1 x 185	1 x 50	2 x 240	2 x 240	
	AWG/MCM	1 x 350 MCM	1 x 1/0 AWG	2 x 500 MCM	2 x 500 MCM	
Degree of protection	–	IP23	IP44	IP23	IP23	
Dimensions (with doors and panels)	Width	mm	1220	1220	620	620
	Height	mm	2310	2210	2310	2310
	Depth	mm	675	675	1330	675 (compact)
	Weight	kg	550	550	900	450

1) On request

2) Suitable for marine use with type certificate; on request

3) Data without taking options into account

8.4 SINAMICS DCM for slip-ring excitation

Table 8-2 Technical data slip-ring excitation

Slip-ring excitation		6RN8011-...			
		...-0SJ42-0AA0	...-1SH42-0AA0	...-6SK42-2AA0	...-4SH41-1AA0 ¹⁾
Rated continuous current	A	1700	1800	1900	1100
Load cycle 20 s / 280 s	A	1900/1500	2000/1500	2200/1500	–
Supply voltage	V	830 3 AC	690 3 AC	950 3 AC	690 3 AC
Voltage range	%	–20 ... +10	–20 ... +10	–20 ... +15	–20 ... +15
Rated supply frequency	Hz	50/60	50/60	50/60	50/60
Frequency range	Hz	45 ... 65	45 ... 65	45 ... 65	45 ... 65
Power loss at the rated continuous current	kW	8.7	8.2	11.4	11.4
Electronics power supply	–	230 V 1 AC, 2 A	230 V 1 AC, 2 A	230 V 1 AC, 2 A	230 V 1 AC, 2 A
Fan power supply	–	400 V 3 AC, 50 Hz, 0.95 A 460 V 3 AC, 60 Hz, 1.25 A	400 V 3 AC, 50 Hz, 0.95 A 460 V 3 AC, 60 Hz, 1.25 A	400 V 3 AC, 50 Hz, 0.95 A 460 V 3 AC, 60 Hz, 1.25 A	400 V 3 AC, 50 Hz, 0.95 A 460 V 3 AC, 60 Hz, 1.25 A
Max. current demand of the auxiliary supply 230 V 1 AC 50/60 Hz ²⁾	A	2.5	2.5	2.5	2.5
Max. current demand of the auxiliary supply 400 V 3 AC 50/60 Hz	A	2	2	2	2
Cooling air flow rate	m ³ /s	0.67	0.67	0.67	0.67
Sound pressure level L _{pA} (1m)	dB(A)	< 87	< 87	< 87	< 87
Measuring surface level L _s (1m)	dB(A)	17	17	17	17
Cable cross-sections, line-side, max. connectable per phase	mm ²	6 x 240	6 x 240	6 x 240	6 x 240
	AWG/MCM	6 x 500 MCM	6 x 500 MCM	6 x 500 MCM	6 x 500 MCM
Cable cross-sections, motor-side, max. connectable per phase	mm ²	6 x 240	6 x 240	6 x 240	6 x 240
	AWG/MCM	6 x 500 MCM	6 x 500 MCM	6 x 500 MCM	6 x 500 MCM
PE connection, max. cross-section at the enclosure with M12 screw	mm ²	3 x 240	3 x 240	3 x 240	3 x 240
	AWG/MCM	3 x 500 MCM	3 x 500 MCM	3 x 500 MCM	3 x 500 MCM
Degree of protection	–	IP23	IP23	IP23	IP23
Dimensions (with doors and panels)					
Width	mm	620	620	620	620
Height	mm	2310	2310	2310	2310
Depth	mm	1330	1330	1330	1330
Weight	kg	900	900	900	900

1) Fuseless; on request

2) Data without taking options into account

9 Accessories

9.1 Accessories for grounding and short-circuiting

9.1.1 Overview

For safety reasons, devices for grounding and short-circuiting the converter are required when working on the converter in the no-voltage condition (IEC 61230). They are required for commissioning or service work, for example, as well as for replacing fans or Powercards/phase modules.

As some of this work has to be performed by operator personnel with the relevant training, the specified tools must be available on the equipment. If these devices are not available, the work must not be performed due to the electrical hazards.

In the case of SINAMICS GM150 and SINAMICS SM150, spherical grounding points are fitted on the input and output side in the area of the connecting busbars which can be short-circuited and grounded with an appropriate three-pole grounding device (grounding harness).

As a rule, this must be done in the de-energized state for all work (in the case of converters with a power section connected in parallel at both infeed points or motor feeders).

If appropriate devices are not available on the equipment, the relevant converter accessories must be supplied in the requisite quantity.

Please note in this case that the number of three-pole grounding devices required is dependent on the number of infeeding three-phase current systems. One grounding device per three-phase current system is required.

If there is a risk of power being fed from the motor side back into the converter, one grounding device per three-phase current system must be fitted here as well.

9.1.2 Selection and ordering data

Description	Article No.
Grounding bar 1000 mm, to connect the grounding device	6SY8101-0AB54
Three-pole grounding device (grounding harness) with universal terminals	6SY8101-0AB58

9.2 Accessories for replacing phase modules

9.2.1 Replacing the complete phase module (SINAMICS GM150 in the IGCT version and SINAMICS SM150 in the IGCT version)

The phase modules of converters with IGCT power semiconductors can be completely replaced by trained personnel. To replace, the entire phase module must be extracted from the converter using a special lifting tool and transported on a stacker truck.

Note:

Before replacing a phase module, it is mandatory that customer service personnel have successfully completed the appropriate training course. Please contact your Siemens sales partner for information about training courses.

Selection and ordering data

Description	Article No.
Contact spray	6SC8476-1DA00-0AA0
Forklift truck RHM23 standard	6SC8476-1EA00-0AA0
Replacement equipment (roller track)	6SL3986-6YX00-0AA0

9.2.2 Replacing individual IGCT modules (SINAMICS SM150 in the IGCT version)

Defective IGCT phase modules, where there is no sign of visible damage, can be repaired by trained personnel by replacing individual IGCT modules. Option B07 must be ordered for this purpose (system engineering for the converter). With this option, a diagnostics program is available that can be used to identify which IGCT module must be replaced.

Note:

Before repairing IGCT phase modules, it is mandatory that customer service personnel have successfully completed the appropriate training course. Please contact your Siemens sales partner for information about training courses.

Note:

This new concept is not available for existing plants and systems, as an upgrade is not possible. However, suitably trained personnel can completely replace defective IGCT phase modules (see Chapter 9.2.1).

9.3 Commissioning tools

STARTER for SINAMICS GM150

The STARTER tool is used to commission SINAMICS GM150 converters. Further information is available in the Internet at:

www.siemens.com/engineering-tools

SIMOTION SCOUT for SINAMICS SM150

SINAMICS SM150 converters are operated using the SIMOTION SCOUT engineering system.

You can find information about this in the Internet at:

www.siemens.com/simotion-scout-tia-portal

10 Motors for converter operation

Overview

The use of variable-speed motors enables savings to be achieved in many applications through higher system efficiencies compared to fixed-speed operation.

Siemens high-voltage motors have proven themselves many times over in variable-speed applications. For these motor series, special versions have been designed for operation with SINAMICS GM150 and SINAMICS SM150 medium-voltage converters.

These motor versions have, as standard, a reinforced stator winding insulation so that they can be fed from drive converters without requiring a sine-wave filter. Further, both bearings are electrically insulated and the shaft is equipped with a grounding system.

The motor insulation system corresponds to thermal class 155 (F) and they are generally utilized to thermal class 155 (F).

For further information, refer to catalogs D 84.2 and D 84.3 for the SIMOTICS HV C and SIMOTICS HV M high-voltage motors:

[Information & Download | Siemens LDA Portal](#)

11 Engineering information

11.1 Current product information

You can find current information on SINAMICS GM150 and SINAMICS SM150 in the LDA Portal at:

- SINAMICS GM150:
[Information & Download | Siemens LDA Portal \(SINAMICS GM150\)](#)
- SINAMICS SM150:
[Information & Download | Siemens LDA Portal \(SINAMICS SM150\)](#)

11.2 Drives Technology Configurator selection tool

Overview

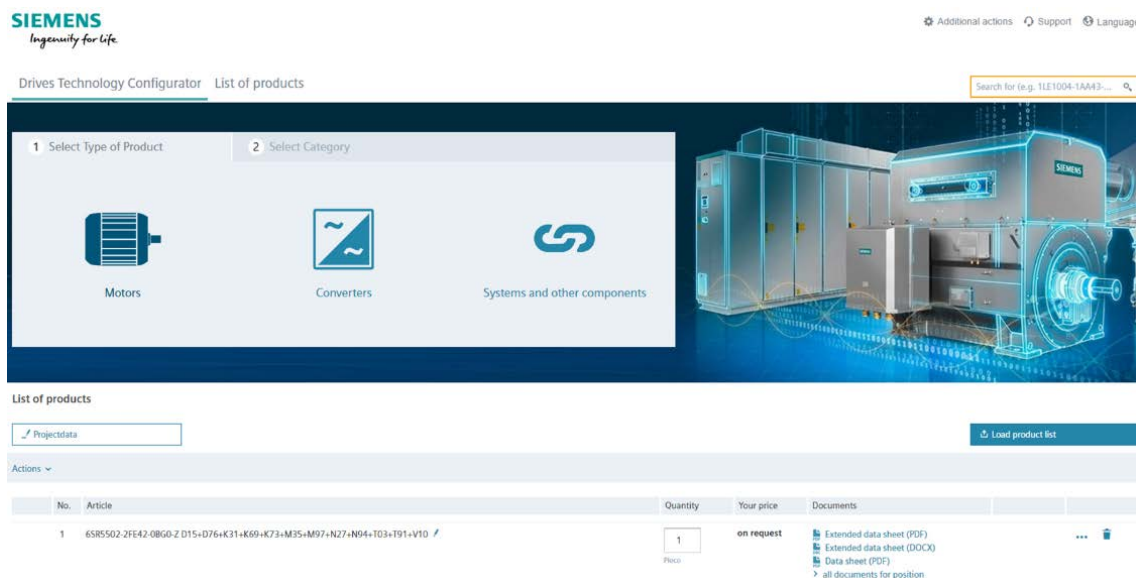

The Drives Technology Configurator is the entry point when it comes to configuring high-voltage motors and medium-voltage converters. It supports you when selecting options and provides all of the relevant technical data sheets and dimension drawings.

Additional information

- You can find the Drives Technology Configurator in the Internet at:
www.siemens.com/dt-configurator
- Home page "Selection and Engineering Tools":
www.siemens.com/engineering-tools

11.3 Overview of interfaces

11.3.1 Overview of connections for SINAMICS GM150

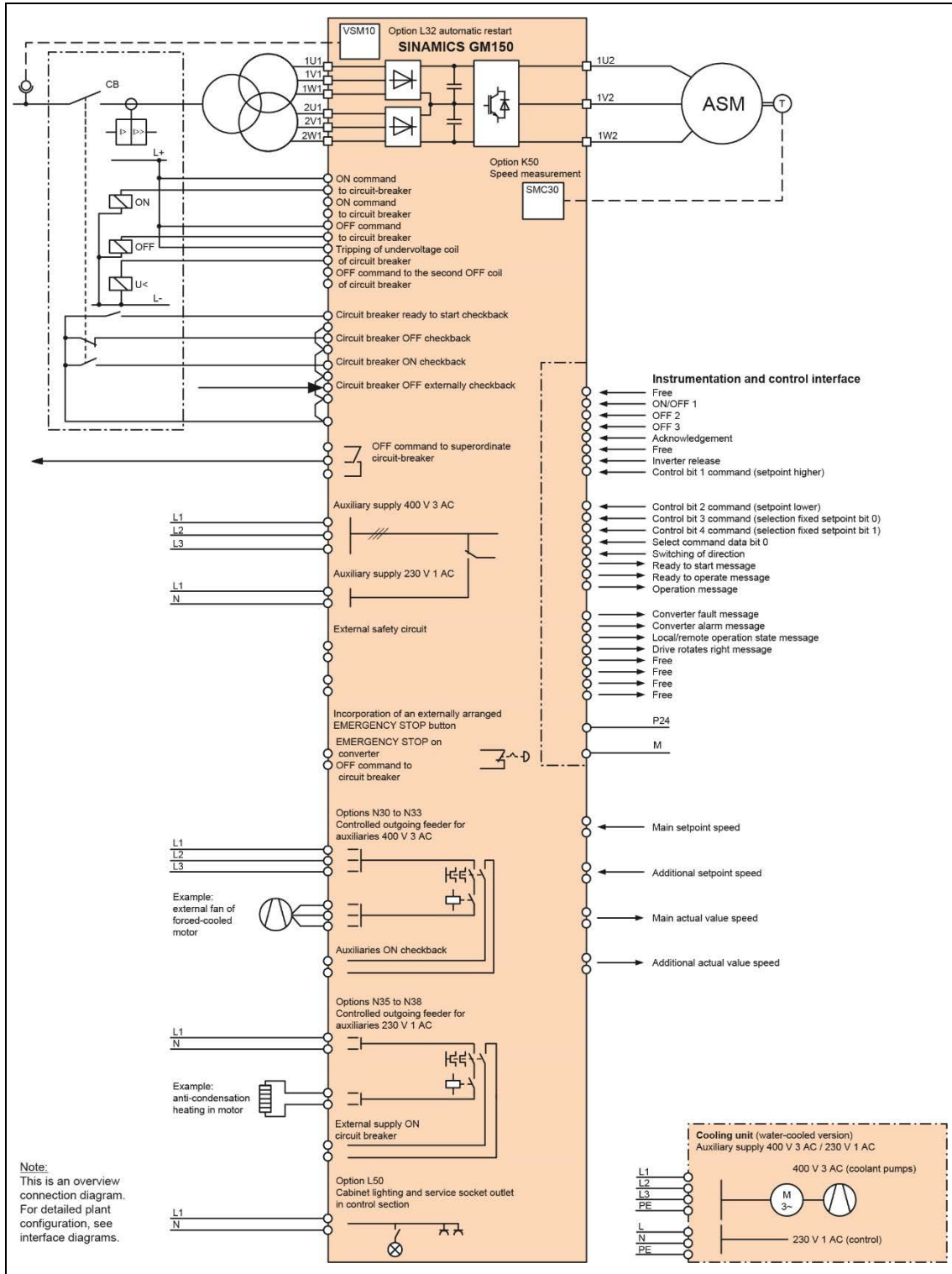

11.3.2 Overview of connections for SINAMICS SM150

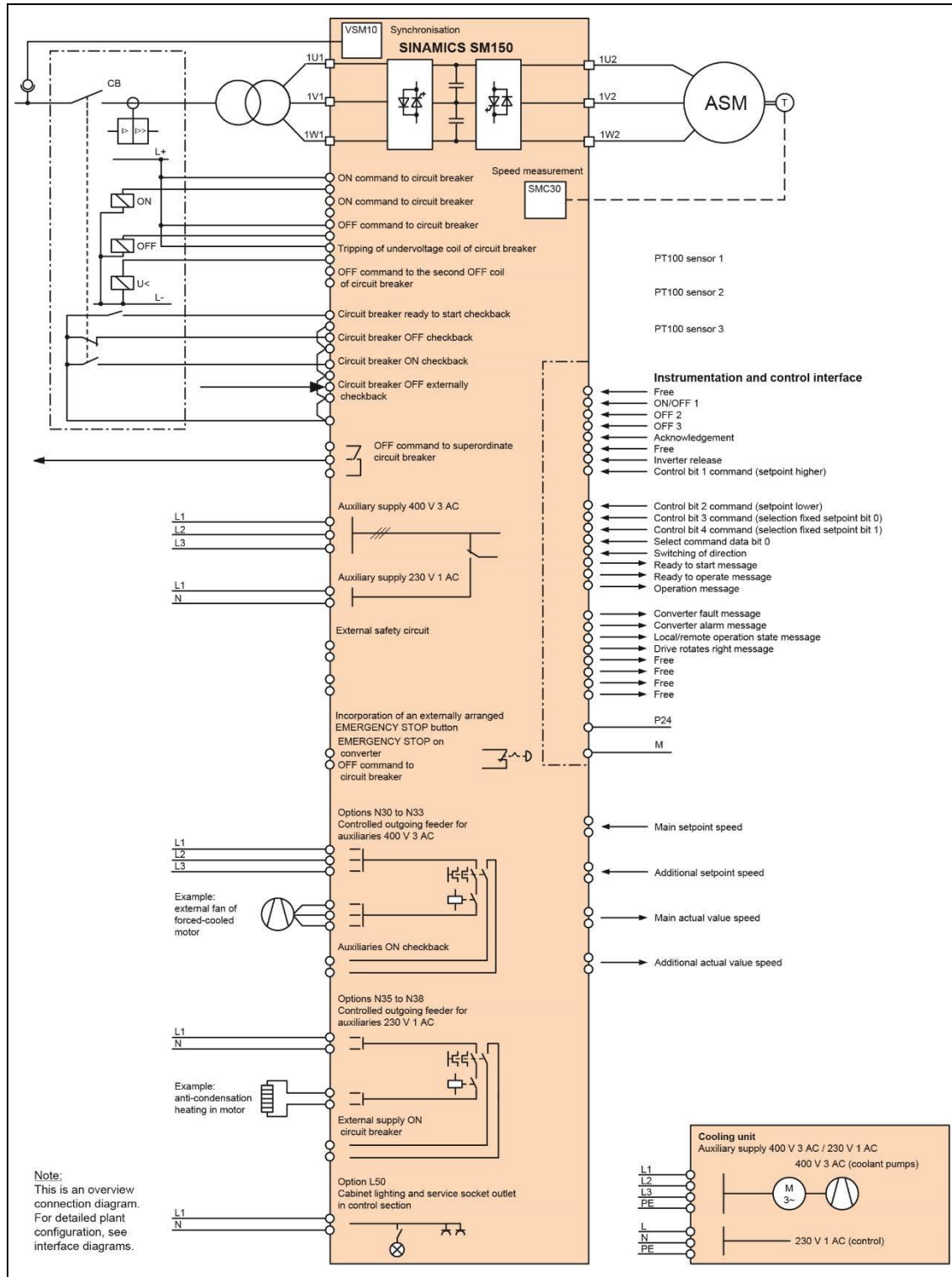

11.4 Cooling unit

11.4.1 Overview

The cooling unit is used to dissipate the power loss from the converter. It consists of an inner deionized water circuit and an outer raw water circuit.

11.4.2 Mode of operation

The hot deionized water in the inner converter circuit is pumped into the water-to-water plate-type stainless steel heat exchanger by two redundant, maintenance-free circulating pumps. This heat exchanger is connected to the raw water circuit on the plant side. The deionized water is cooled by the raw water of the outer circuit and flows back into the converter.

The closed inner deionized water circuit is filled with deionized water and vented using an expansion tank (reservoir). This expansion tank is located at the highest point of the cooling circuit.

11.4.3 Function

Raw water specifications

The raw water must be chemically neutral, clean and free of solids. Other quality requirements to be met by the raw water are listed in the following table.

Property	Value
Grain size of any entrained parts	< 0.5 mm
pH value	6.5 ... 8.0
Carbonate hardness	< 0.9 mMol/l (5 °dH)
Total hardness	< 1.7 mMol/l (9.5 °dH)
Chloride content	60 mg/l
Sulfate content	80 mg/l
Nitrate content	10 mg/l
Iron content (Fe)	0.2 mg/l
Ammoniac content	10 mg/l
Dissolved substances	< 3.4 mMol/l (340 ppm)

In case of deviations it is recommended to carry out an analysis of the water in order to ensure the heat exchanger's endurance strength. In case of aggressive cooling water (including sea water), plate-type heat exchangers made of titanium should be used (options **W11** and **W12**).

Avoiding condensation

To avoid condensation at excessively low raw water temperatures, a three-way valve for controlling the water temperature is installed as standard.

Specifications of the cooling water in the deionized water circuit

Clean water (battery water) should be used to fill and top-up the deionized water circuit

11.4 Cooling unit

Deionized water	In accordance with IEC 60993
Specific conductivity when filled in	$\leq 30 \mu\text{S}/\text{cm}^1$
Evaporation residue	$< 20 \text{ mg}/\text{l}$
pH value	5 ... 9
Content of <ul style="list-style-type: none"> metals from the hydrogen sulfide group (lead, antimony, tin, bismuth, arsenic, copper, cadmium) metals from the ammonium sulfide group (iron, cobalt, nickel, chrome, manganese) sulfur and nitrogen chloride compounds 	Not detectable
Content of oxidizable, organic substances	Max. a quantity equivalent to the usage of 30 mg/l potassium permanganate KMnO_4

1) After the converter is filled and before the converter is switched on, the conductivity value is reduced to the permitted operating value of $< 1.0 \mu\text{S}/\text{cm}$ by the ion exchanger which is integrated in the cooling unit.

Monitoring devices in the deionized water circuit

To guarantee the self-protection of the converter, the deionized water is monitored by the converter:

- Conductivity measurement:
The conductivity of the cooling water is constantly monitored in order to ensure that the leakage currents in the drive between different voltage levels and with respect to ground remain low. An ion exchanger (in the cooling unit) maintains the conductivity below the permitted maximum value of $1.0 \mu\text{S}/\text{cm}$. If the conductivity is too high, the ion exchanger filling must be changed. After the first year, an ion exchanger filling must be changed at least every two years as a rule.
- Temperature monitoring
- Flow monitoring
- Leakage water monitoring

Other monitoring operations and the control of the electrical equipment are performed in the cooling unit:

- A compensating tank for the compensation of changes in the volume of cooling water due to evaporation or temperature changes
- Indication of pressure in the converter inlet

The operating status is signaled to the converter.

Piping

The cooling unit consists of one transport unit and is supplied without deionized water.

For SINAMICS GM150 in the IGBT version and SINAMICS SM150 in the IGBT version, a pipe-connecting element between the cooling unit and converter is included in the scope of delivery. As standard, the water connections are located on the side.

For SINAMICS GM150 in the IGCT version and SINAMICS SM150 in the IGCT version, the piping between the cooling unit and the basic unit is realized below the units (refer to example shown in following diagram). The necessary pipes and connection pieces are included in the scope of delivery and are supplied loose. Rigid pipes are used (stainless steel). The converter is connected to the stainless steel pipes using flexible hoses.

Special installation conditions have not been taken into account and, where applicable, a separate inquiry is necessary (e.g. where the cooling unit is not mounted directly next to the basic unit).

The piping for the raw water supply on the plant side is not included.

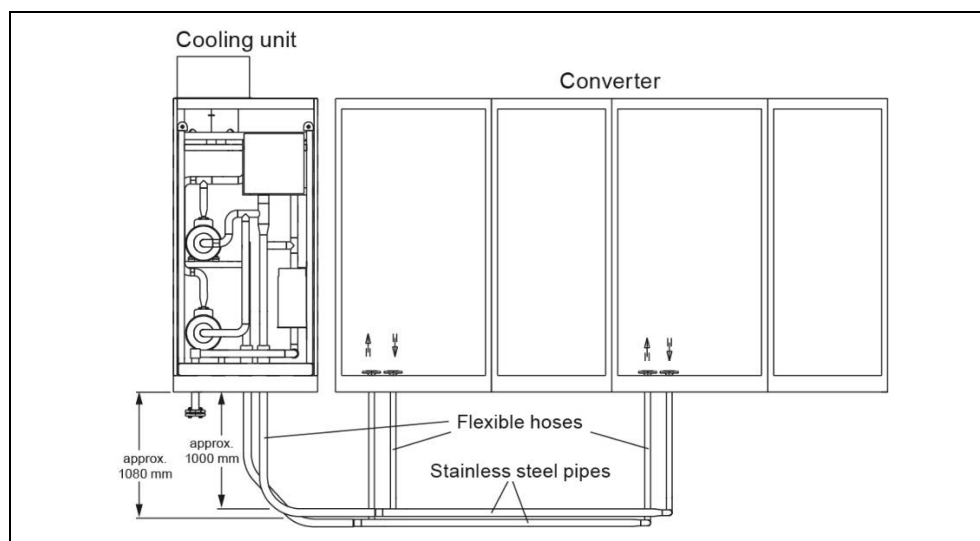

Fig. 11-1 Piping for SINAMICS GM150 in the IGCT version and for SINAMICS SM150 in the IGCT version

Options

Redundancy (options **W02** and **W12**)

On request, the cooling unit can be designed for fully redundant operation, i.e. two plate-type heat exchangers are provided. In this case, defective parts can be exchanged while the system continues to run.

Tube-nest heat exchanger (on request)

If the raw water quality deviates from the standard values specified above (e.g. the water contains suspended particles), on request, a tube-nest heat exchanger can be used.

Notice:

A supplementary cabinet is required if a tube-nest heat exchanger is used.

The following additional options are available on request:

- External air-to-water heat exchanger (on request)
An external air-to-water heat exchanger can be used on request if there is no process water available on the plant side. In this case, the ambient temperature may be a maximum of 35 °C.
- Chiller (heat exchanger, on request)
If there is no process water on the plant side and if the ambient temperature exceeds 35 °C, then on request a chiller (incl. compressor) can be used.
- Cooling unit specification (on request)
When option **W14** is selected (converter without cooling unit), specifications of the cooling unit are available on request.

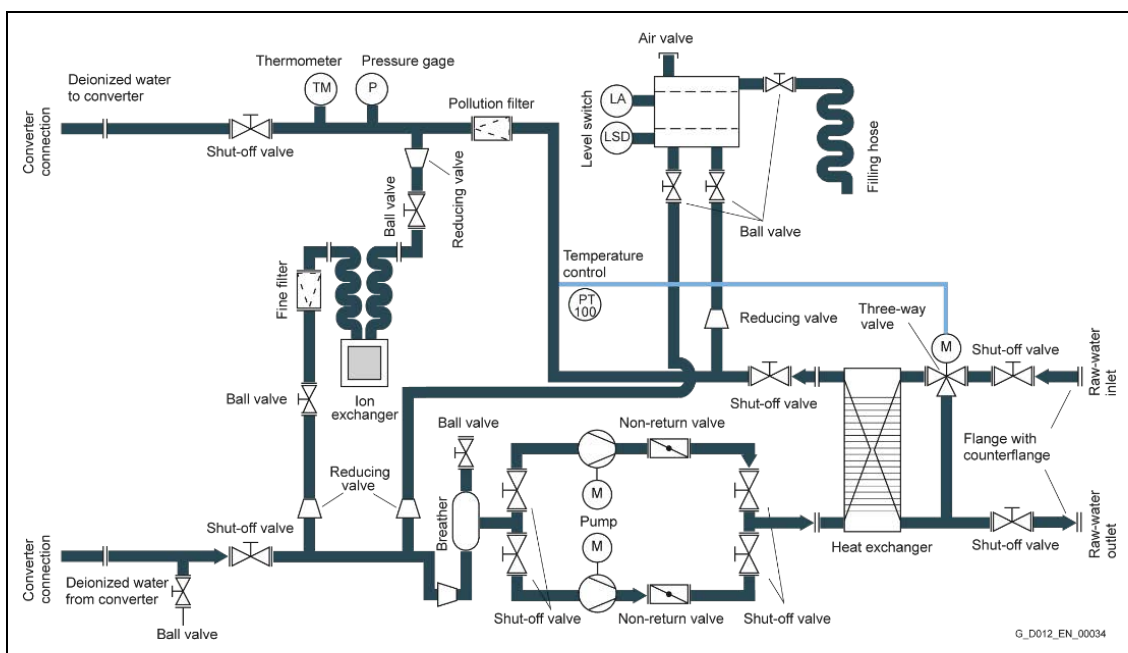

Fig. 11-2 Flowchart of the cooling unit

11.4.4 Technical specifications

Technical data of the cooling unit	
Degree of protection	
• Cabinet	IP20
• All internal components	IP54
Supply voltage	
3/N/PE/AC 400 V ±10 %, 50/60 Hz ±3 %	
Raw water circuit	
• Inlet temperature	+5 ... +35 °C (with derating also higher values; see derating diagrams in section 2.6.2, 3.7.2, 4.6.2 or 5.6.2; lower values than +5 °C on request)
• Temperature rise in converter, max.	10 K (for minimum flow)
• Input pressure	2 ... 10 bar
Pressure drop	1 ... 1.5 bar

11.5 Circuit breakers

Engineering

The circuit breaker placed on the primary side of the input transformer on the plant side belongs to the safety system of the converter. If a fault occurs inside the converter, the energy that is effective at the fault location must be limited. This is realized as a result of the inductance of the incoming transformer, which limits the rate-of-rise and magnitude of the current and the circuit breaker that trips as quickly as possible.

For the above conditions to be satisfied, the circuit breaker used must have the following characteristics:

- The total opening time of the circuit breaker – from the command to actually opening – must not be more than 80 ms. This means that the opening time, specified in the technical documentation of the circuit breaker manufacturer, must not be longer than 80 ms. The converter monitors the total opening time.
- The converter monitors the TRIP coils (shunt releases) for wire breakage and failure of the control voltage in the switchgear installation.
- The circuit breaker must be fitted with an undervoltage trip unit. The undervoltage trip unit (low-voltage coil) is controlled by way of the tripping chain in which the "undervoltage trip unit" of the converter must also be integrated. The auxiliary voltage from the switchgear (this is a reliable supply) is used as the supply.
- Additional delay times in controlling the circuit breaker must be avoided. All commands from the converter to the circuit breaker must act directly, without recourse to any coupling relays.
- A separate check-back signal must exist for each of the circuit breaker states ON and OFF. The checkbacks must not be delayed, i.e. no coupling relays may be used.
- An additional, independently operating overcurrent protection for the circuit breaker must be provided on the plant side (transformer and cable protection).
- Under no circumstances may the circuit breaker be electrically or mechanically closed externally. A mechanical interlock of the manual ON command on the circuit breaker prevents destruction of the converter by uncoordinated switch-on.

Supplementary notes

Surge voltage protection

The point where the converter transformer is connected to the line supply must be equipped with appropriate surge voltage protection against transient overvoltages (caused by lightning strikes in the line supply, circuit breaker switching operations etc.), and/or against surge voltages initiated by switching operations in the regenerative feedback module of the converter.

According to IEC 60076-11, plant and system design engineers must implement these protection measures if surge voltages can be caused as a result of lightning strikes or as a result of the system itself. To protect the interface specified above against transient surge voltages, starting from the Line Module (capable of energy recovery), it is recommended that not only the pulse pattern attributes are taken into account, but also the parameters of the feeding transformer and the parameters of the cabling between the drive and circuit breaker.

Please contact a system engineer to check if there is adequate surge voltage protection or whether this protection must be retrofitted.

Circuit breaker failure protection

In the case of fuselessly operated converters, it should be ensured that the higher-level line-side circuit breaker switches off in the event of a fault if the circuit breaker of the converter transformer does not trip despite an OFF command being applied. It is recommended to equip the medium-voltage switchgear with an appropriate protection function for this purpose (e.g. breaker failure protection according to ANSI 50BF).

11.6 Transformers

Overview

The SINAMICS GM150 and SINAMICS SM150 converters are always connected to the medium-voltage network through a converter transformer.

By using the transformer the drive (converter and motor) are disconnected from the network and electrically isolated:

- The short-circuit power is limited to a maximum permissible value.
- Converter and motor are operated ground-free.
- The line harmonics and the voltage ripple are limited.

An insulation monitor, integrated in the converter, monitors the insulation state of the transformer secondary winding up to the motor.

Configurations for SINAMICS GM150

For the 12-pulse Basic Line Module of the SINAMICS GM150 converter, a three-winding transformer is required. The secondary windings of the three-winding transformer have a phase shift around 30°el, resulting in a 12-pulse infeed with accordingly smaller circuit feedbacks.

For the 24-pulse Basic Line Module, two three-winding transformers are required. Two transformers with primary windings offset through 15° are used.

In this case, it must be ensured that the individual secondary windings have the same voltage, in order to reduce the line harmonics and to ensure a symmetrical current distribution. In this case, a maximum deviation of 1 % is permissible for the two secondary windings connected in parallel.

Instead of the two three-winding transformers a five-winding transformer can also be used in consultation with the transformer manufacturer.

SINAMICS GM150 transformer secondary voltages

Transformer secondary voltages when using three-winding or five-winding transformers:

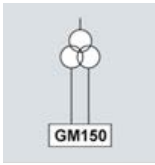
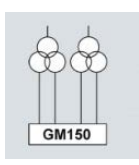
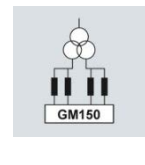
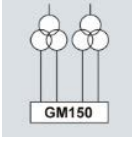
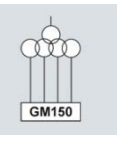
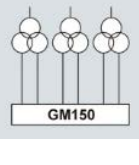
SINAMICS GM150 (IGBT) and SINAMICS GM150 (IGCT)						
Circuit	Single connection of Motor Module		Parallel connection of Motor Modules			
Infeed	12-pulse	24-pulse	12-pulse	24-pulse		36-pulse
Circuit version (Fig. No.)	1, 7	2, 8	–	3, 9	–	10
Infeed transformers	1 three-winding transformer 	2 three-winding transformers 	1 three-winding transformer, 4 line reactors 	2 three-winding transformers 	1 five-winding transformer 	3 three-winding transformers 
Offset between the transformer secondary windings	30 °	15 °	30 °	15 °	15 °	10 °
Converter: U _{Nconv} in kV	Transformer: Secondary voltage U _{sec} in kV (no-load voltage)					
2.3	2 × 1.2	2 × (2 × 1.2) ¹⁾	–	–	–	–
3.3 (IGBT)	2 × 1.7	2 × (2 × 1.7) ¹⁾	2 × 1.7	2 × (2 × 1.7)	4 × 1.7	–
3.3 (IGCT)	2 × 1.7	2 × (2 × 0.85) ¹⁾	–	2 × (2 × 1.7)	–	3 × (2 × 1.7)
4.16	2 × 2.2	2 × (2 × 2.2) ¹⁾	2 × 2.2	2 × (2 × 2.2)	4 × 2.2	–

1) Single connection with option N15

Transformer secondary voltages when using two-winding transformers:

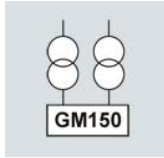
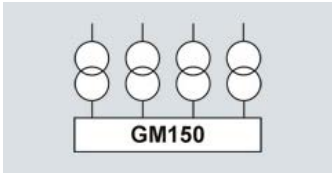
SINAMICS GM150 (IGBT) and SINAMICS GM150 (IGCT)			
Circuit	Single connection of Motor Module		Parallel connection of Motor Modules
Infeed	12-pulse	24-pulse	
Circuit version (Fig. No.)	–	–	–
Infeed transformers	2 two-winding transformers 	4 two-winding transformers 	
Offset between the transformer secondary windings	30 °	15 °	15 °
Converter: U_{Nconv} in kV	Transformer: Secondary voltage U_{sec} in kV (no-load voltage)		
2.3	2 × 1.2	4 × 1.2 ¹⁾	4 × 1.2
3.3 (IGBT)	2 × 1.7	4 × 1.7 ¹⁾	4 × 1.7
3.3 (IGCT)	2 × 1.7	4 × 0.85 ¹⁾	4 × 1.7
4.16	2 × 2.2	4 × 2.2 ¹⁾	4 × 2.2

1) Single connection with option N15

Configurations for SINAMICS SM150

For detailed information, please contact your Siemens sales partner.

11.7 Power cables

General information

The cable selection and cable dimensioning depend on various factors (e.g. temperature, routing type, cable type, EMC requirements, local regulations).

This is the reason that it should be noted that the following data represent recommendations only. The system integrator is responsible for dimensioning the cables.

Motor cables

If the SINAMICS GM150 and SINAMICS SM150 converters are operated without sine-wave filters, higher voltages arise on the motor terminals and hence on the cable due to the switching edges. Suitable cables must be selected, therefore, to meet the EMC and voltage endurance requirements. Different technical characteristics result in differences between the converters with IGBT power sections and those with IGCT power sections.

The correct cable cross-section depends not only on the motor current but also on the number of cables which are routed in parallel, the routing conditions and the ambient temperature. It must be determined for each individual case. Local installation regulations must be observed in addition.

A finely stranded cable for equipotential bonding between the motor and converter should be installed parallel to the power cables. Local regulations must be observed in this case too.

SINAMICS GM150 in the IGBT version and SINAMICS SM150 in the IGBT version (without sine-wave filter)

Shielded three-core medium-voltage cables must be used to connect the converter to the motor. For converters with an output voltage of 2.3 kV, cables for a minimum of 3.6/6 kV are adequate. For converters with output voltages of 3.3 kV and 4.16 kV, cables for a minimum of 6/10 kV are required. Symmetrical cables with individually shielded copper conductors are recommended. An additional common outer shield is an advantage for improving the EMC characteristics. The cable capacitances must not exceed the following values.

Cable cross-section	Cable capacitance
3 × 240 mm ²	0.6 µF/km
3 × 95 ... 185 mm ²	0.5 µF/km
3 × 70 mm ²	0.4 µF/km

Single-core, shielded cables are permissible if three cables are routed in a triangular arrangement without clearance between the cables as cable bundle on the cable tray. The symmetrically arranged cable bundle comprises one cable for every phase (three-phase system). The cable bundles are arranged next to one another on the cable tray. The clearance between them corresponds to twice the outer diameter of a single-core cable. The cable bundles have alternating rotating fields – clockwise and counter-clockwise.

EMC-FC (Frequency Converter) cables should be used for increased requirements regarding EMC. Their EMC-optimized cable design reduces the

11.7 Power cables

radio interference radiation and radio interference voltage when compared to standard medium-voltage cables.

SINAMICS GM150 in the IGBT version and SINAMICS SM150 in the IGBT version (with sine-wave filter, only on request)

For operation with a sine-wave filter there are no special requirements to be met by the cables from the converter to the motor. When using unshielded medium-voltage cables, some type of cable armor is recommended in order to ensure the mechanical ruggedness of the cables. For a rated motor voltage of 3.3 kV and lower, the rated cable voltage is 3.6/6 kV. For a rated motor voltage above 3.3 kV, the rated cable voltage is 6/10 kV.

SINAMICS GM150 in the IGCT version and SINAMICS SM150 in the IGCT version

Shielded three-core medium-voltage cables for 6/10 kV must be used to connect the converter to the motor. Symmetrical cables with individually shielded copper conductors are recommended. An additional common outer shield is an advantage for improving the EMC characteristics. The cable capacitances must not exceed the following values.

Cable cross-section	Cable capacitance
3 × 240 mm ²	0.6 μF/km
3 × 95 ... 185 mm ²	0.5 μF/km
3 × 70 mm ²	0.4 μF/km

Single-core, shielded cables are permissible if three cables are routed in a triangular arrangement without clearance between the cables as cable bundle on the cable tray. The symmetrically arranged cable bundle comprises one cable for every phase (three-phase system). The cable bundles are arranged next to one another on the cable tray. The clearance between them corresponds to twice the outer diameter of a single-core cable. The cable bundles have alternating rotating fields – clockwise and counter-clockwise.

EMC-FC (Frequency Converter) cables should be used for increased requirements regarding EMC. Their EMC-optimized cable design reduces the radio interference radiation and radio interference voltage when compared to standard medium-voltage cables.

Cables between the transformer and the converter

The same versions apply as in the case of the motor cables.

Permissible cable lengths

In the case of long cables between the converter and the motor, reflection phenomena lead to overvoltages and recharging currents on the cables and at the motor terminals and, in turn, to a higher level of stress on the motor insulation. The motor insulation is additionally subject to stress as a result of the voltage rates of rise (voltage gradients).

The increased stress on the cables and motor as a result of reflection phenomena in the case of long cables can be significantly reduced using a sine-wave filter at the converter output (option **Y15**, on request for IGBT versions).

The recharging currents in the cables and in the motor can be significantly reduced by using reactors or filters at the drive output (options **L08/L78** or **L10**).

Maximum cable lengths between converter and motor, without and with output reactor or dv/dt Filter:

Converter output voltage	Maximum cable length ¹⁾		
SINAMICS GM150 IGBT version and SINAMICS SM150 IGBT version			
	<u>Without output reactor (standard)</u>	<u>With output reactor (option L08)</u>	<u>With output reactor with damping (option L78) ³⁾</u>
2.3 kV	1 or 2 parallel cables: 100 m each 3 parallel cables: 80 m each	1 or 2 parallel cables: 1000 m each 3 or 4 parallel cables: 600 m each	Up to 4 parallel cables: 1000 m each
3.3 kV	4 parallel cables: 80 m each	1 or 2 parallel cables: 575 m each 3 or 4 parallel cables: 350 m each	Up to 4 parallel cables: 1000 m each
4.16 kV		1 or 2 parallel cables: 350 m each 3 parallel cables: 225 m each 4 parallel cables: 150 m each	1 or 2 parallel cables: 1000 m each 3 or 4 parallel cables: 350 m each (greater lengths on request)
SINAMICS GM150 IGCT version and SINAMICS SM150 IGCT version			
	<u>Without dv/dt filter (standard)</u>	<u>With dv/dt filter (option L10) ²⁾</u>	–
3.3 kV	Up to 2 parallel cables: 100 m each 3 parallel cables: 80 m each 4 parallel cables: 80 m each	200 m each (greater lengths on request)	–

- 1) Distance converter-motor depending on the current load for max. of four shielded three-conductor cables connected in parallel. Mechanically, up to six parallel cables are possible (on request).
- 2) **L10** option description see section 7.2.
- 3) **L78** option on request only; for plant/system-specific solutions, please also contact your Siemens sales partner.

Maximum cable lengths between line-side transformer and converter:

Converter output voltage	Maximum cable lengths	
	Shielded	Unshielded
SINAMICS GM150		
2.3 kV to 4.16 kV	300 m	Not permitted
SINAMICS SM150		
3.3 kV	100 m	Not permitted

Note:

Converter cable length data are based on the following assumption:

- Max. ambient temperature 40 °C
- Max. number of cables routed in parallel: 4
- Max. cable cross-section: 240 mm²
- Max. output frequency: 150 Hz

Longer cable lengths are possible for lower ambient temperatures, output frequencies, currents, cable cross-sections – or fewer cables routed in parallel. You can obtain plant/system-specific information from your Siemens sales partner.

11.8 System integration

Protective measures against transient overvoltages

Converters, converter transformers and motors are components of a variable-speed drive system (VFDS), which is connected to a line supply. In these line supplies, surge voltages can occur as a result of lightning strikes or switching operations. The line-side drive system connection (generally the windings of the converter transformer primary) must be protected against these transient overvoltages using an appropriate overvoltage protection device.

The components of a VFDS are designed, as standard, for the lowest rated lightning surge voltage of the associated voltage class, laid down in the applicable standards. According to IEC 61936-1 (VDE 0101-1), plant and system design engineers must protect components against surge voltages that are caused by lightning strikes or switching operations – and which exceed the lightning surge voltage as laid down in the standard.

Within the context of integrating the converter in a VFDS, it is the responsibility of the system integrator (or plant/system design engineer) to evaluate as to whether adequate surge voltage protection is guaranteed or additional protective measures are required.

11.9 Motors

General notes on operating high-voltage motors

High-voltage motors can generate a voltage if they are driven by the load as a result of the inherent plant or system principle. The magnitude of this voltage essentially depends on the speed and the type of excitation of the high-voltage motor. The following must be noted in order to ensure that the converter power section safely and reliably operates while the high-voltage motor is rotating:

- For permanent-magnet synchronous motors, options **L49** (make-proof grounding switch at the converter output) and **L52** (circuit breaker at the converter output) must be selected.
- For induction motors and separately excited synchronous motors, if the motor is driven by the load, then options **L49** and **L51/L52** (depending on the particular application) should be selected.

Operating Siemens high-voltage motors

A sine-wave filter is not required between the Siemens high-voltage motors and special motors for e.g. marine, rolling mill and high-speed applications and the SINAMICS GM150 and SINAMICS SM150 converters. Reliable operation of the drive is assured by the following measures:

- The MICALASTIC insulation system used in VPI technology is also ideal for the voltage load arising during converter operation.
- The protection concept for high voltage motors when fed from converters involves two insulating bearings to avoid damaging bearing currents. Further, shaft grounding is absolutely necessary so that no voltage can be established at the motor shaft with respect to ground. The shaft is either grounded using a rotary pulse encoder with integrated grounding track on the non-drive end or using a separate grounding brush on the motor drive end. In the first case, an insulated coupling must be used. This is because as a result of the shaft grounding at the non-drive end, circulating currents can flow through the driven load. In the second case, the rotary pulse encoder must be mounted at the non-drive end so that it is insulated; an insulated coupling is not required.

Minimum motor rated frequency:

- SINAMICS GM150 in the IGBT version and SINAMICS SM150 in the IGBT version: 20 Hz
- SINAMICS GM150 in the IGCT version and SINAMICS SM150 in the IGCT version:
 - 8.5 Hz for an output voltage of 3.3 kV
 - 5.0 Hz for a reduced voltage of 3.15 kV

Note:

Please contact your Siemens sales partner in the case of different data.

Note:

For motors with a rated frequency of less than 8.5 Hz, a reduced voltage of 3.15 kV should always be selected.

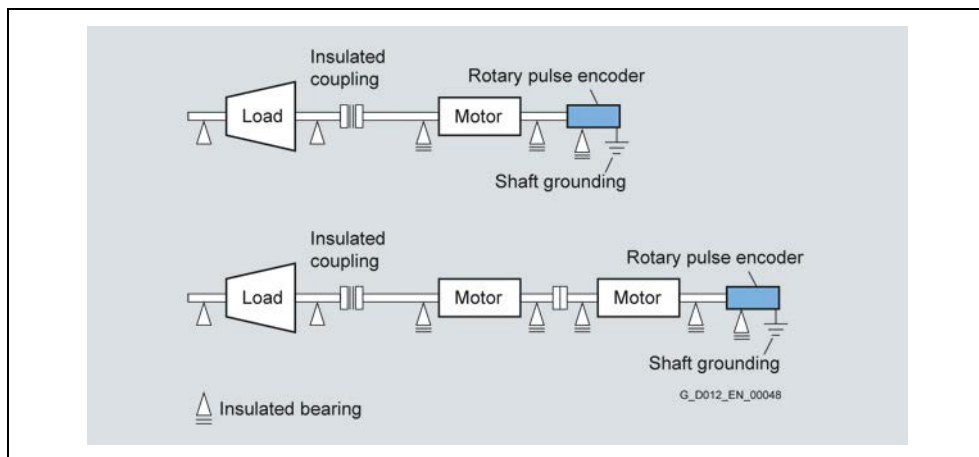

Fig. 11-3 Shaft grounding at the non-drive end

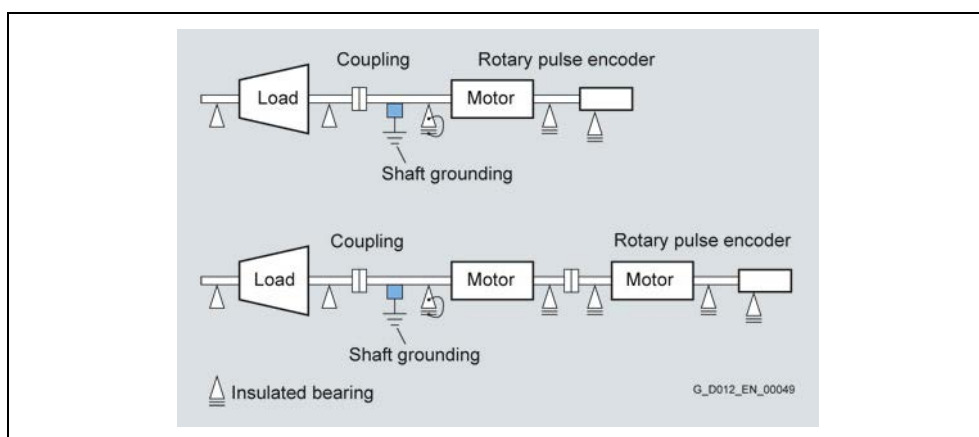

Fig. 11-4 Shaft grounding at the drive end

Operating motors with several winding systems

To increase the output power of the converters it is possible to operate several power sections in parallel. In this way, a maximum power rating of up to 13 MVA with an output voltage of 4.16 kV can be achieved by connecting two SINAMICS GM150 in the IGBT version converters in parallel. Using the same principle, a maximum power rating of 21 MVA or 31.5 MVA is achieved by connecting three SINAMICS GM150, in the IGCT version and SINAMICS SM150 converters in parallel.

To ensure a uniform division of current between the two subsystems, two or three electrically isolated but mutually non-displaced winding systems are required in the motor.

Operating two-pole motors

High-speed converter drives with 2-pole motors require special engineering regarding their mechanical design (limiting and critical speed, bearings, rotor design, foundation design). An inquiry is required for such applications.

In the case of retrofit applications it is necessary to ensure that the motors have no mechanical natural resonance in the provided setting range. Affected speed ranges can be suppressed by the converter if necessary.

Operating explosion-protected motors

Motors from Siemens are also available in versions for use in areas subject to explosion hazard.

Drives for a square-law load torque

Driven loads with a square-law load torque ($M \sim n^2$) such as pumps and fans, require the full torque at rated speed. Increased starting torques or load surges do not usually occur. It is therefore unnecessary to provide an overload capability for the converter.

The following applies when selecting a suitable converter for driven loads with a square-law load torque: The rated current of the converter must be at least as large as the motor current at full torque in the required load point.

Drives for a constant load torque

Self-ventilated motors cannot provide their full rated torque in continuous operation over the complete speed range. The continuous permissible torque decreases as the speed decreases because of the reduced cooling effect. Depending on the speed range, the torque – and thus the power – must be reduced accordingly for self-cooled motors.

For frequencies above the rated frequency f_N , force-ventilated motors are operated in the field-weakening mode. In this case, the torque that can be utilized decreases with approx. f_N/f . The power remains constant. Thus, a safety margin of $\geq 30\%$ to the stall torque must be observed, which decreases according to the function $(f_N/f)^2$.

Drives with overload requirements

The rated data of the converters specified in the technical specifications provide no reserves for overload capability. The current rating of the converter must always be reduced if the specifications call for an increased overload capability of the converter. The size of the required power reduction differs according to the application, operating mode and converter type. The derating can be determined on request if all of the boundary conditions are specified.

Operating line motors (only for SINAMICS GM150 in the IGBT version)

In conjunction with the optional sine-wave filter (option **Y15**, on request) the SINAMICS GM150 in the IGBT version is ideal for the operation of line motors in applications with a square law load torque (e.g. pumps and fans). The near sinusoidal output voltages and currents rule out all loading of the insulating system and bearings. The sine-wave filters supply the motors with almost sinusoidal motor currents and voltages so that line motors can be operated. The sine-wave filter operates optimally for motors with a rated frequency of 50 Hz or 60 Hz. It should be noted that only driven loads with a square-law load torque may be operated (e.g. pumps, fans). The output frequencies used in operation can lie in the range between 30 Hz and 66 Hz.

A field weakening range of 1:1.1 is permissible (max. 55 Hz for 50 Hz motors and max. 66 Hz for 60 Hz motors).

The voltage harmonic distortion at an output frequency of 50 Hz is less than 5 % when using a sine-wave filter.

In order to optimally adapt the sine-wave filter to the motor, the rated motor current, the motor current at the rated point and the motor no-load current must be specified when ordering.

11.10 Scope of delivery

The standard scope of delivery of the SINAMICS GM150 and SINAMICS SM150 comprises:

1. Basic unit

The basic unit consists of the converter power section incl. closed-loop control, in either an air-cooled or water-cooled version. One or more transport units are supplied depending on the converter type. Exact details are to be found in the dimension drawing for the specific order.

SINAMICS SM150 includes a VSM10 Voltage Sensing Module in the basic unit. The VSM10 detects the line supply voltage regarding phase position, frequency and amplitude. A voltage transformer, which should be provided on the primary side of the circuit breaker (plant-side) is used for this purpose.

2. Cooling unit for water-cooled converters

The cooling unit consists of one transport unit and is supplied without deionized water.

For SINAMICS GM150 in the IGBT version, a pipe-connecting element between the cooling unit and converter is included in the scope of delivery.

For SINAMICS GM150 in the IGCT version and SINAMICS SM150 in the IGCT version, the piping between the cooling unit and the basic unit is routed below the units. The necessary pipes and connection pieces are included in the scope of delivery and are supplied loose.

Special installation conditions have not been taken into account and, where applicable, a separate inquiry is necessary (e.g. where the cooling unit is not mounted directly next to the basic unit).

The piping for the raw water supply on the plant side is not included.

3. Optional components

Optional components, e.g. sine-wave filters or output reactors, are delivered as separate transport units. If necessary, cables for connecting the optional components to the power section are delivered as well. For the DC bus configurations of SINAMICS SM150, the cabling between the basic unit and the option cabinets is routed below the units. The cables required are not included in the scope of delivery as they have to be selected according to the particular project.

4. Static excitation unit

A static excitation unit is generally included in the scope of delivery for converters to supply synchronous motors. This must be ordered with a separate Article number (see Accessories, Chapter 8).

The following are *not* included in the standard scope of delivery:

- Cables between the transformer and the converter
- Motor cables
- Circuit breakers
- Transformer
- Motor
- Cable ducts
- Filter systems
- Piping for the raw water circuit of the cooling unit
- Voltage transformer for the synchronizing voltage of the VSM10
- Sector-neutral parameter assignment for SINAMICS SM150

12 SIDRIVE IQ



Drive systems play a key role in countless production processes and are ultimately what keeps the entire production going. Faults or failures involving components like motors and drives have costly consequences.

Avoiding these faults by taking timely and deliberate action requires intelligent transparency – which allows for measures like targeted, proactive, and well-timed maintenance.

The future is digital – especially in the industrial sector. Thanks to digitalization and networked processes, companies can produce more flexibly and reliably, and they can respond to events more rapidly. Digitally enhanced drive components are an important step toward digitalized automation. With SIDRIVE IQ, you can now benefit from an Industrial Internet of Things (IIoT) digitalization solution for drive systems. Take advantage of digitalization to enter a new dimension of availability, serviceability, productivity and efficiency.

Reap the fruits of digitalization for medium voltage drives and high voltage motors with SIDRIVE IQ. The trinity of smart products, optimized plant designs and services provides you, with the insights you need, to make proactive choices you can trust – every single time.

With our **smart products** and systems with edge-capability you are able to make drive systems an “Industrial IoT platform device” for interoperability with automation and application.

Our **digital platform** gives you the perfect integration in IoT ecosystems through modularity, scalability and connectivity with data model and processing libraries and functional user interaction and experience. Increase availability, optimize your asset management and processes for faster decision-making and a boost of productivity.

Digital Services by SIDRIVE IQ is the cloud-based approach for the next generation of remote and condition monitoring services. With SIDRIVE IQ, condition data from the drive train components is transferred to the cloud and analyzed by our service experts.

SIDRIVE IQ – our holistic solution and service to IIoT for your drive systems

[siemens.com/sidrive-iq](https://www.siemens.com/sidrive-iq)

13 Services and documentation

13.1 Services for Large Drives Applications



Keep your business running and shape your digital future – with Services for Large Drives Applications

Optimizing the productivity of your equipment and operations can be a challenge, especially with constantly changing market conditions. Working with our service experts makes it easier. We understand your industry's unique processes and provide the services needed so that you can better achieve your business goals.

You can count on us to maximize your uptime and minimize your downtime, increasing your operations' productivity and reliability. When your operations have to be changed quickly to meet a new demand or business opportunity, our services give you the flexibility to adapt.

We assist in keeping your operations as energy and resource efficient as possible and reducing your total cost of ownership. As a trendsetter, we ensure that you can capitalize on the opportunities of digitalization and by applying data analytics to enhance decision making: You can be sure that your plant reaches its full potential and retains this over the longer lifespan.

You can rely on our highly dedicated team of engineers, technicians and specialists to deliver the services you need – safely, professionally and in compliance with all regulations. We are there for you, where you need us, when you need us.

[siemens.com/lda-service](https://www.siemens.com/lda-service)

13.1 Services for Large Drives Applications

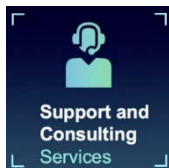

Our **LDA Portal** delivers comprehensive information, application examples, FAQs and support requests: lda-portal.siemens.com

Technical Support and Diagnostic: Advice and answers for all inquiries about functionality, handling, and fault clearance.

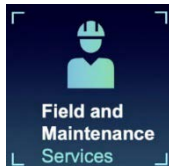

A worldwide network of specially trained service personnel provides you with a highly quality service and an optimized commissioning time. By making use of a regular inspection and health check, you can maximize the availability of your plant and optimize your production processes.

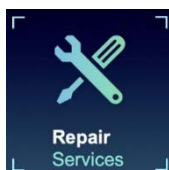

Repair Services are offered on-site and in regional repair centers for fast restoration of faulty devices' functionality. Also available are extended repair services, which include additional diagnostic and repair measures, as well as emergency services.

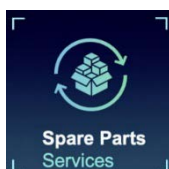

Spare Parts Services are available worldwide for smooth and fast supply of spare parts – and thus optimal plant availability. Genuine spare parts are available for up to ten years. Logistic experts take care of procurement, transport, custom clearance, storage and order management. Reliable logistics processes ensure that components reach their destination as fast as needed. Since not all spare parts can be kept in stock at all times, Siemens offers a preventive measure for spare parts provisioning on the customer's premises with optimized **Spare Parts Packages** for

individual products, custom-assembled drive components and entire integrated drive trains – including risk consulting.

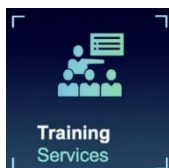

From the basics and advanced to specialist skills, **LDA training courses** provide expertise right from the manufacturer – and encompass the entire spectrum of Siemens LDA products and systems for the industry.

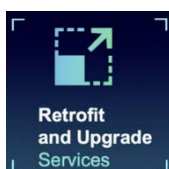

Use **Retrofit Services** to extend the lifetime of your machinery and plants. Optimize the availability, reliability and energy efficiency of your installed motors and drives by retrofitting existing products and systems.

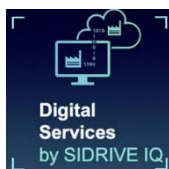

To provide you with optimum support in your work, we have put together two digital service packages as part of our digital offering SIDRIVE IQ. The first package, **SIDRIVE IQ Rapid Response**, is all about getting your equipment up and running again as quickly as possible. The second package, **SIDRIVE IQ Guided Supervision**, is a service package specifically for continuous monitoring.

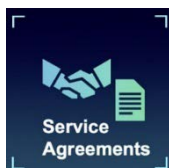

A **Service Agreement** enables you to easily bundle a wide range of services into a single annual or multiyear agreement. You pick the services you need to match your unique requirements or fill gaps in your organization's maintenance capabilities. Programs and agreements can be customized as KPI-based and/or performance-based contracts.

13.2 Training Center

SINAMICS medium-voltage converters

We are the world leader in engineering and manufacturing medium voltage drives: with the largest installed base, market share and overall portfolio. The know-how acquired in our courses will enable you to implement drive applications in your plant efficiently.

Our learning offer includes courses on the following medium-voltage converters:

- SINAMICS PERFECT HARMONY GH150
- SINAMICS PERFECT HARMONY GH180
- SINAMICS GL150
- SINAMICS GM150
- SINAMICS SH150
- SINAMICS SM150
- SINAMICS SL150

The standard training language is English.

Training concepts

- In our classroom at Nuremberg, Germany
- As an online training with remote access to real devices and video transmission

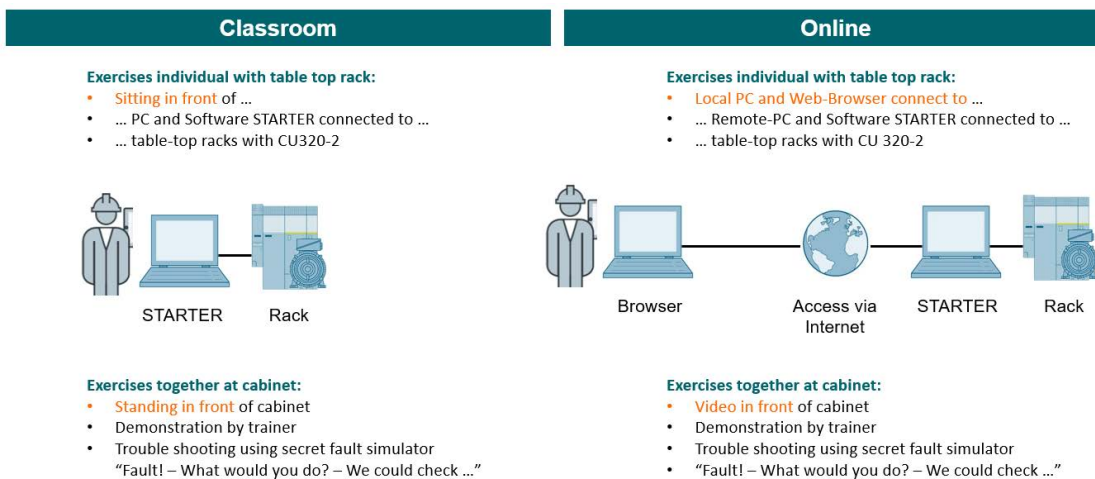

Range of training courses for SINAMICS GM150 and SINAMICS SM150

Course title	Course ID
SINAMICS GM150	
SINAMICS GM150 – Diagnostics and Service https://www.lda-portal.siemens.com/siemlda/en/training/detail/LD-GM150-DGE-classroom	LD-GM150-DGE
SINAMICS SM150	
SINAMICS SM150 – Diagnostics and Service https://www.lda-portal.siemens.com/siemlda/en/training/detail/LD-SM150-DGE-classroom	LD-SM150-DGE
SINAMICS SM150 – Repair of IGCT Phase Modules https://www.lda-portal.siemens.com/siemlda/en/training/detail/LD-SM150-RP-classroom	LD-SM150-RP

Additional information

Detailed up-to-date information on course contents, dates and prices can be found on the internet under the address [Training Services | Siemens LDA Portal](#).

13.3 Documentation

Overview

The technical documentation for SINAMICS GM150 and SINAMICS SM150 is provided for download in the PDF format.

It consists of the following sections:

- Operating Instructions
- List Manual (parameter lists and function diagrams)
- Equipment-specific documents such as circuit diagrams, dimension drawings, layout diagrams and terminal diagrams

The documentation language is in English. Other languages can be optionally ordered (see "Description of the options", Chapter 7.2).

Get more information

SINAMICS Drives:

www.siemens.com/sinamics

SINAMICS GM150:

www.siemens.com/sinamics-gm150

SINAMICS SM150:

www.siemens.com/sinamics-sm150

Published by
Siemens AG

Large Drives Applications
Vogelweiherstr. 1-15
90441 Nuernberg
Germany

Produced in Germany
© Siemens 2023

Subject to changes and errors. The information given in this document only contains general descriptions and/or performance features which may not always specifically reflect those described, or which may undergo modification in the course of further development of the products. The requested performance features are binding only when they are expressly agreed upon in the concluded contract.

All product designations may be trademarks or other rights of Siemens AG, its affiliated companies or other companies whose use by third parties for their own purposes could violate the rights of the respective owner.

For the U.S. published by
Siemens Industry Inc.

100 Technology Drive
Alpharetta, GA 30005
United States

Security information

Siemens provides products and solutions with industrial security functions that support the secure operation of plants, systems, machines and networks.

In order to protect plants, systems, machines and networks against cyber threats, it is necessary to implement – and continuously maintain – a holistic, state-of-the-art industrial security concept. Siemens' products and solutions constitute one element of such a concept.

Customers are responsible for preventing unauthorized access to their plants, systems, machines and networks. Such systems, machines and components should only be connected to an enterprise network or the internet if and to the extent such a connection is necessary and only when appropriate security measures (e.g. firewalls and/or network segmentation) are in place.

For additional information on industrial security measures that may be implemented, please visit
<https://www.siemens.com/industrialsecurity>

Siemens' products and solutions undergo continuous development to make them more secure. Siemens strongly recommends that product updates are applied as soon as they are available and that the latest product versions are used. Use of product versions that are no longer supported, and failure to apply the latest updates may increase customer's exposure to cyber threats.

To stay informed about product updates, subscribe to the Siemens Industrial Security RSS Feed under
<https://www.siemens.com/cert>